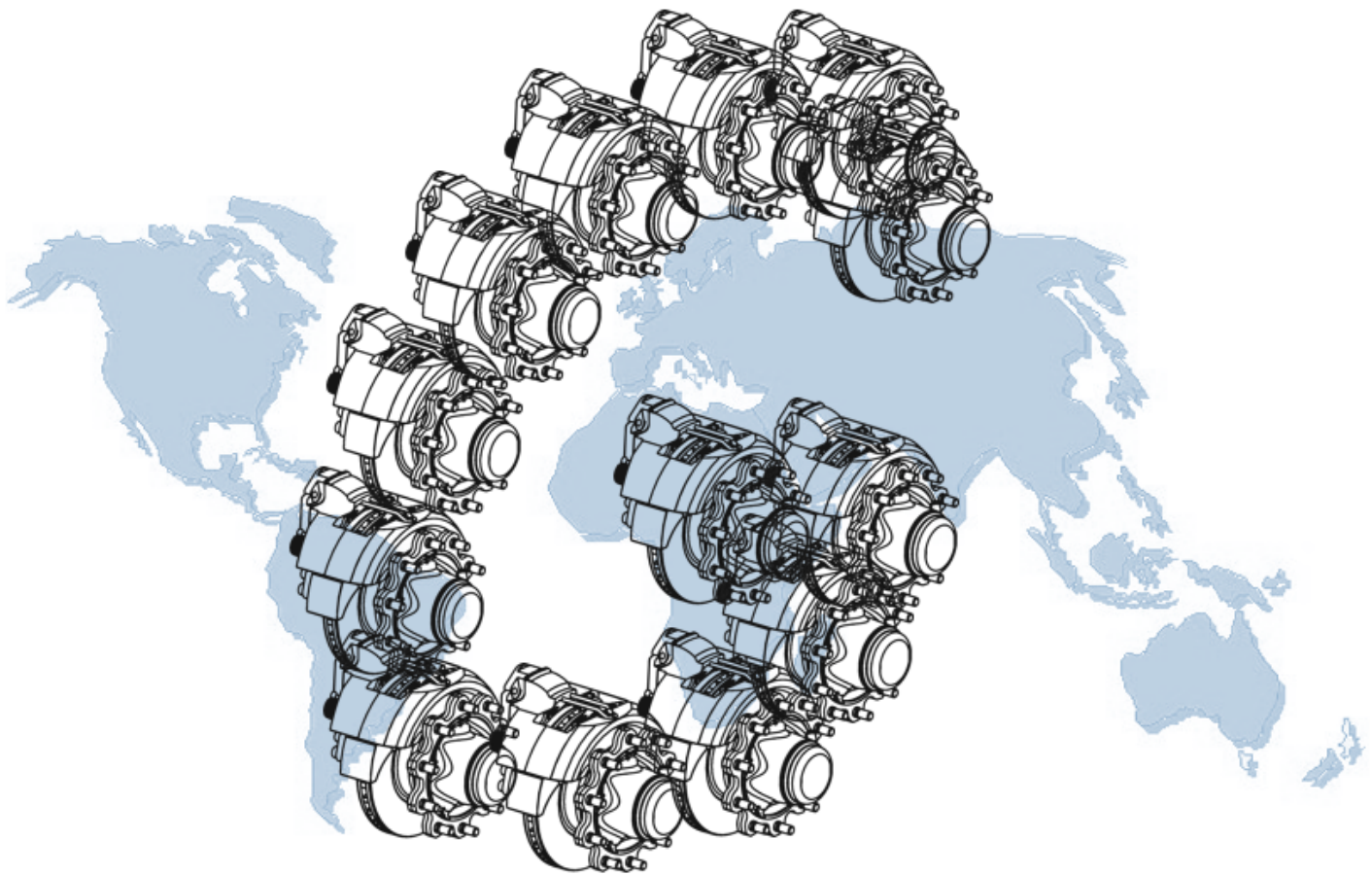
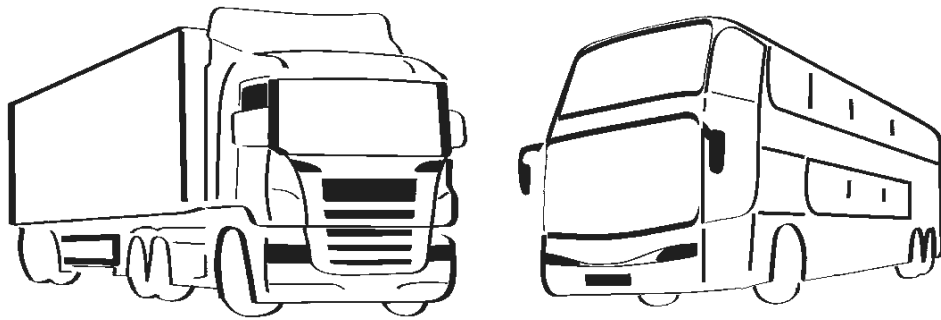




CATALOGUE FREIN A DISQUE POIDS LOURDS
ETRIERS, PLAQUETTES & DISQUES

CATALOG FOR CV DISC BRAKE PARTS
CALIPERS, PADS & DISCS







CATALOGUE FREIN A DISQUE POIDS LOURDS ETRIERS, PLAQUETTES & DISQUES

CATALOG FOR CV DISC BRAKE PARTS CALIPERS, PADS & DISCS



 SOMMAIRE	PAGE
RECOMMANDATIONS	3
STRUCTURE DES RÉFÉRENCES GIL ÉTRIER RE-MANUFACTURÉ	4
TUTORIEL D'UTILISATION DU CATALOGUE	4
VUE D'ENSEMBLE ÉTRIER RE-MANUFACTURÉ	5-11
RECHERCHE PLAQUETTES DE FREIN PAR DIMENSIONS	12-30
RECHERCHE DISQUES DE FREIN PAR DIMENSIONS	31-84
APPLICATION PAR VEHICULES	85-234
PIECES DETACHEES ETRIER DE FREIN	235-240
ILLUSTRATIONS	241-269
CORRESPONDANCES DES REFERENCES	270-421
TRADUCTION	422-433
AVIS DE NON-RESPONSABILITÉ	434

 SUMMARY	PAGE
RECOMMANDATIONS	3
PART NUMBERS STRUCTURE GIL REMANUFACTURED CALIPERS	4
HOW TO USE THE CATALOG	4
OVERVIEW OF REMANUFACTURED CALIPERS	5-11
BRAKE PADS RESEARCH BY SIZE	12-30
BRAKE DISC RESEARCH BY SIZE	31-84
APPLICATION BY VEHICLES	85-234
CALIPERS SPARE PARTS	235-240
DRAWINGS	241-269
CROSS REFERENCE LIST	270-421
TRANSLATION	422-433
DISCLAIMER	434





RECOMMANDATIONS / RECOMMANDATIONS



Les étriers mécaniques de freins flottants sont commandés par un cylindre de frein à ressort ou à diaphragme pneumatique, prévus pour être utilisés sur les essieux avant et arrière des véhicules utilitaires et remorques pour des jantes de 17,5", 19,5" ou 22,5" en tant que freins de service, de secours et de stationnement.

Des disques de frein et plaquettes de frein en bon état sont nécessaires pour un bon comportement de conduite et de freinage, qui sont déterminants pour assurer la sécurité.

Le remplacement des plaquettes et disques de frein doit toujours être réalisé par essieu !

Réaliser les travaux de réparation uniquement avec les outils appropriés.

Toujours dérégler ou régler le frein manuellement à l'aide d'une clé adaptée et ne jamais utiliser d'outils électriques ou pneumatiques.

Les travaux de réparation doivent se conclure par un contrôle final sur le banc d'essai ou effectuer une conduite test avec des tests de freinage.

Veuillez-vous conformer aux manuel et recommandations de montage du constructeur.



Mechanical floating calipers brakes are controlled by a spring brake cylinder or pneumatic diaphragm intended to be used on the front and rear axles of commercial vehicles and trailers for 17.5", 19.5" or 22.5" wheels as service brakes, emergency and parking.

Brake discs and brake pads in good condition are necessary for a good driving behavior and braking, which are critical for safety.

Replacement of brake pads and discs must always be done axle by axle.

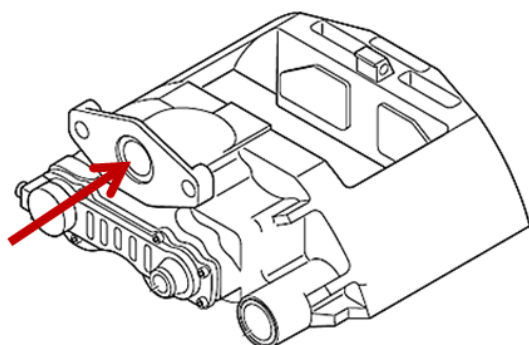
Proceed to repairs only with the proper tools.

Always disorder or adjust the brake manually using a suitable spanner and never use electric or pneumatic tools.

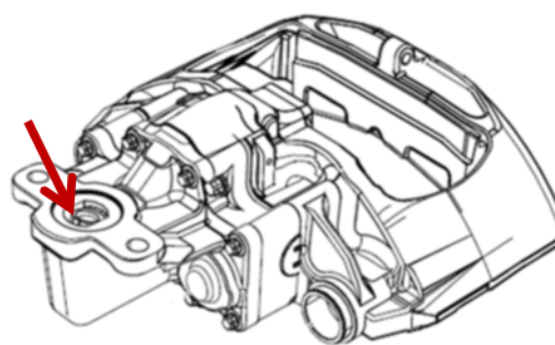
Repair work should conclude with a final check on the test bench, then road tests with braking tests.

Please refer to the manual's and the manufacturer's installation recommendations.

AXIAL



RADIAL






STRUCTURE DES RÉFÉRENCES GIL ÉTRIER RE-MANUFACTURÉ
PART NUMBERS STRUCTURE GIL REMANUFACTURED CALIPER

	REF GIL	WABCO	HALDEX	KNORR	MERITOR	BENDIX	BPW
17.5"	EFR5	EFR50XX		EFR53XX	EFR56XX		
19.5"	EFR6	EFR60XX	EFR62XX	EFR63XX	EFR66XX	EFR69XX	EFR695X
22.5"	EFR7	EFR70XX	EFR72XX	EFR73XX	EFR76XX	EFR79XX	EFR795X
22.5"	EFR7				EFR77XX		


TUTORIEL D'UTILISATION DU CATALOGUE
HOW TO USE THE CATALOG

 Après ouverture du catalogue, veuillez taper les touches de votre clavier (**Ctrl+F**), une case va s'ouvrir (en vert) taper par exemple HALDEX, appuyer sur entrée, vous remarquerez que vous arrivez sur les applications pour HALDEX, appuyer sur entrée vous irez aux étriers pour le HALDEX et vous continuez cette procédure afin de trouver le restant des pièces pour le HALDEX.

Vous pouvez également effectuer une recherche d'un numéro OES exemple:

Veillez taper les touches de votre clavier (**Ctrl+F**), écrivez 7421471917 puis entrée vous arriverez directement à la référence EFR5000

Après avoir trouvé la référence EFR5000, vous pouvez la copier en la surbrillant puis (**Ctrl+C**) et téléchargez le tarif général puis (**Ctrl+F**) et (**Ctrl+V**) pour coller, puis entrée, vous trouverez alors le prix et le code de remise du produit dans ce cas c'est VI.

 After opening the catalog, please type on your keyboard (**Ctrl + F**), a box will open (green) eg type HALDEX, press enter, you will notice that you get the master cylinder HALDEX, press on entry then go to the caliper application for HALDEX and you continue this process to find the remaining parts for HALDEX.

You can also search an OES number example:

Please type in your keyboard (**Ctrl + F**), then write 7421471917 entry you arrive at the reference EFR5000

After finding the part number EFR5000, you can copy the highlighted (**Ctrl + C**) and then download list price (**Ctrl + F**) and (**Ctrl + V**) to paste and Enter, you then find the price and the product discount code in this case is VI.



17,5" KNORR SB-SN5 POTENTIO. CONTINU	EFR5300 EFR5301
17,5" KNORR SB-SN5 POTENTIO. O/F	EFR5302 EFR5303
17,5" KNORR SB-SN5 POTENTIO. CONTINU VIS	EFR5304 EFR5305
19,5" KNORR SB-SN6 AXIAL (5°+)	EFR6300 EFR6301
19,5" KNORR SB-SN6 AXIAL (15°+)	EFR6302 EFR6303
19,5" KNORR SB-SN6 AXIAL (5°+) POTENTIO. O/F	EFR6304 EFR6305
19,5" KNORR SB-SN6 AXIAL (5°+) POTENTIO. CONTINU	EFR6306 EFR6307
19,5" KNORR SB-SN6 AXIAL (5°+)	EFR6310 EFR6311
19,5" KNORR SB-SN6 AXIAL (0°)	EFR6312 EFR6313
19,5" KNORR SB-SN6 AXIAL (5°+) POTENTIO. CONTINU	EFR6314 EFR6315
19,5" KNORR SB-SN6 AXIAL (5°+) POTENTIO. CONTINU CLIP	EFR6317 EFR6316
22,5" KNORR SK7	EFR6308 EFR6309
22,5" KNORR ST7 AXIAL (0°)	EFR7354 EFR7355



SB5 (g/l)



SN5 (d/r)



SN6 (d/r)



SB6-7 (g/l)



SK7 (g/l)



ST7 (g/l)

22,5" KNORR SB-SN7 AXIAL (-12°)	EFR7300 EFR7301
22,5" KNORR SB-SN7 AXIAL (0°)	EFR7302 EFR7303
22,5" KNORR SB-SN7 AXIAL (-12°) POTENTIO. CONTINU	EFR7304 EFR7305
22,5" KNORR SB7 RADIAL (86°+)	EFR7306 EFR7307
22,5" KNORR SB-SN7 AXIAL (0°) POTENTIO. O/F	EFR7308 EFR7309
22,5" KNORR SB-SN7 AXIAL (0°) POTENTIO. CONTINU VIS	EFR7310 EFR7311
22,5" KNORR SB-SN7 AXIAL (12°+) POTENTIO. CONTINU	EFR7312 EFR7313
22,5" KNORR SB7 RADIAL (93°+)	EFR7314 EFR7315
22,5" KNORR SB7 RADIAL (93°+) POTENTIO. CONTINU VIS	EFR7316 EFR7317
22,5" KNORR SB-SN7 AXIAL (0°) POTENTIO. CONTINU CLIP	EFR7320 EFR7321
22,5" KNORR SB7 RADIAL (93°+) POTENTIO. CONTINU CLIP	EFR7322 EFR7323
22,5" KNORR SB-SN7 RADIAL (86°+) POTENTIO. CONTINU VIS	EFR7324 EFR7325
22,5" KNORR SB-SN7 AXIAL (0°) POTENTIO. CONTINU VIS	EFR7326 EFR7327
22,5" KNORR SB-SN7 AXIAL (0°) POTENTIO. O/F CLIP	EFR7328 EFR7329
22,5" KNORR SB-SN7 AXIAL (-12°) POTENTIO. CONTINU CLIP	EFR7332 EFR7333
22,5" KNORR SB-SN7 AXIAL (86°+) POTENTIO. CONTINU CLIP	EFR7334 EFR7335
22,5" KNORR SB-SN7 AXIAL (8°+)	EFR7336 EFR7337
22,5" KNORR SB7 RADIAL (3°+) POTENTIO. CONTINU VIS	EFR7340 EFR7341
22,5" KNORR SB-SN7 AXIAL (0°) POTENTIO. CONTINU VIS	EFR7344 EFR7345
22,5" KNORR SL7 AXIAL (-12°) POTENTIO. CONTINU VIS	EFR7346 EFR7347
22,5" KNORR SM7 AXIAL (-12°) POTENTIO. ON/OFF VIS	EFR7348 EFR7349
22,5" KNORR SL7 AXIAL (-12°) POTENTIO. ON/OFF VIS	EFR7350 EFR7351
22,5" KNORR SM7 AXIAL (0°) POTENTIO. CONTINU VIS	EFR7352 EFR7353



SB7 (g/l)



SN7 (d/r)



SL-SM7 (g/l)



SL-SM7 (d/r)



17,5" MERITOR B DUCO	EFR7618 EFR7619
19,5" MERITOR C DUCO	EFR6620 EFR6621
19,5" MERITOR C DUCO	EFR6626 EFR6627
19,5" MERITOR C LISA	EFR6654 EFR6655
19,5" MERITOR DX 195	EFR6650 EFR6651
19,5" MERITOR ELSA 195 AXIAL	EFR6656 EFR6657
19,5" MERITOR ELSA 195 LE	EFR6602 EFR6603
19,5" MERITOR VGT 195	EFR6600 EFR6601
22,5" MERITOR D DUCO AXIAL	EFR7616 EFR7617
22,5" MERITOR D DUCO AXIAL	EFR7622 EFR7623
22,5" MERITOR D DUCO AXIAL	EFR7630 EFR7631
22,5" MERITOR D DUCO RADIAL	EFR7624 EFR7625
22,5" MERITOR D ELSA 2	EFR7658 EFR7659
22,5" MERITOR D ELSA 2	EFR7660 EFR7661
22,5" MERITOR D ELSA 2	EFR7664 EFR7665
22,5" MERITOR D ELSA 2	EFR7666 EFR7667
22,5" MERITOR D ELSA 2	EFR7668 EFR7669
22,5" MERITOR D ELSA 2	EFR7672 EFR7673
22,5" MERITOR D ELSA 2	EFR7674 EFR7675
22,5" MERITOR D ELSA 2	EFR7684 EFR7685
22,5" MERITOR D ELSA 2	EFR7694 EFR7695
22,5" MERITOR D ELSA 2	EFR7716 EFR7717
22,5" MERITOR D ELSA 2	EFR7718 EFR7719
22,5" MERITOR D ELSA 2	EFR7700 EFR7701
22,5" MERITOR D LISA	EFR7610 EFR7611
22,5" MERITOR D LISA	EFR7612 EFR7613
22,5" MERITOR D LISA	EFR7614 EFR7615
22,5" MERITOR D2	EFR7652 EFR7653
22,5" MERITOR D2	EFR7710 EFR7711



DUCO Axial (d/r)



DUCO Radial (g/l)



DX 195 (g/l)



D 3 (d/r)



LISA (g/l)



ELSA 2 (d/r)



22,5" MERITOR D3	EFR7600 EFR7601
22,5" MERITOR D3	EFR7602 EFR7603
22,5" MERITOR D3	EFR7604 EFR7605
22,5" MERITOR D3	EFR7606 EFR7607
22,5" MERITOR D3	EFR7608 EFR7609
22,5" MERITOR DX 225 (15-16)	EFR7714 EFR7715
22,5" MERITOR DX 225 (17-18)	EFR7712 EFR7713
22,5" MERITOR DX 225 (21-22)	EFR7670 EFR7671
22,5" MERITOR ELSA 1	EFR7632 EFR7633
22,5" MERITOR ELSA 1	EFR7634 EFR7635
22,5" MERITOR ELSA 1	EFR7636 EFR7637
22,5" MERITOR ELSA 1	EFR7638 EFR7639
22,5" MERITOR ELSA 1	EFR7640 EFR7641
22,5" MERITOR ELSA 1	EFR7642 EFR7643
22,5" MERITOR ELSA 1	EFR7644 EFR7645
22,5" MERITOR ELSA 1	EFR7646 EFR7647
22,5" MERITOR ELSA 1	EFR7648 EFR7649
22,5" MERITOR ELSA 1	EFR7696 EFR7697
22,5" MERITOR ELSA 2	EFR7692 EFR7693
22,5" MERITOR ELSA 2	EFR7698 EFR7699
22,5" MERITOR ELSA 2	EFR7702 EFR7703
22,5" MERITOR ELSA 2	EFR7706 EFR7707
22,5" MERITOR ELSA 2	EFR7720 EFR7721
22,5" MERITOR ELSA 225-1 AXIAL	EFR7680 EFR7681
22,5" MERITOR ELSA 225-1 AXIAL	EFR7690 EFR7691
22,5" MERITOR ELSA 225-3 AXIAL	EFR7678 EFR7679
22,5" MERITOR ELSA 225-3 AXIAL	EFR7686 EFR7687
22,5" MERITOR ELSA 225-3 AXIAL	EFR7688 EFR7689
22,5" MERITOR ELSA 225-3 RADIAL	EFR7676 EFR7677
22,5" MERITOR ELSA 225L-2 AXIAL	EFR7704 EFR7705
22,5" MERITOR LE DUCO	EFR7628 EFR7629



ELSA 1 Radial (d/r)



ELSA 1 Axial (g/l)



LISA (g/l)






ELSA 225 Radial (g/l)



ELSA 225 Axial (d/r)

(g/l) : Gauche/Left (d/r) : Droit/Right

  	
17,5" WABCO 1000 V-G	EFR5008 EFR5009
17,5" WABCO MAXX 17	EFR5010 EFR5011
17,5" WABCO MAXX 17	EFR5012 EFR5013
17,5" WABCO PAN 17	EFR5000 EFR5001
17,5" WABCO PAN 17	EFR5002 EFR5003
17,5" WABCO PAN 17	EFR5006 EFR5007
19,5" WABCO 1300 V-G	EFR6124 EFR6125
19,5" WABCO 1600 V-G	EFR5004 EFR5005
19,5" WABCO MAXX 19	EFR6012 EFR6013
19,5" WABCO MAXX 19	EFR6014 EFR6015
19,5" WABCO PAN 19-1 Plus	EFR6006 EFR6007
19,5" WABCO PAN 19-1 Plus	EFR6004 EFR6005
19,5" WABCO PAN 19-2	EFR6002 EFR6003
22,5" WABCO MAXX 22	EFR7004 EFR7005
22,5" WABCO MAXX 22	EFR7006 EFR7007
22,5" WABCO MAXX 22L	EFR7010 EFR7011
22,5" WABCO PAN 22-1	EFR7002 EFR7003
22,5" WABCO PAN 22-2	EFR7000 EFR7001



PAN 19/22-2 (g/l)



PAN 19/22-1 (d/r)



PAN 17 (g/l)



MAXX 22 (d/r)

(g/l) : Gauche/Left (d/r) : Droit/Right

VUE D'ENSEMBLE ÉTRIER RE-MANUFACTURÉ HALDEX OVERVIEW OF REMANUFACTURED CALIPERS HALDEX



19,5" HALDEX DB 19	EFR6200 EFR6200
19,5" HALDEX DB 19	EFR6201 EFR6201
19,5" HALDEX DBT 19LT	EFR6202 EFR6203
22,5" HALDEX DB 22	EFR7200 EFR7200
22,5" HALDEX DB 22	EFR7201 EFR7201
22,5" HALDEX DB 22	EFR7208 EFR7208
22,5" HALDEX DB 22	EFR7209 EFR7209
22,5" HALDEX DB 22 LT	EFR7204 EFR7204
22,5" HALDEX DBT 22LT	EFR7206 EFR7207
22,5" HALDEX DBT 22LT	EFR7210 EFR7211
22,5" HALDEX MODULX DB 22	EFR7202 EFR7202
22,5" HALDEX MODULX DB 22	EFR7203 EFR7203



MODULX DB 19/DB 22 (g/l)/(d/r)

VUE D'ENSEMBLE ÉTRIER RE-MANUFACTURÉ BPW OVERVIEW OF REMANUFACTURED CALIPERS BPW

19,5" BPW TSB3709 ECO DISC	EFR6950 EFR6951
19,5" BPW TS2 3709 ECO DISC	EFR6952 EFR6953
22,5" BPW TSB4309 ECO DISC	EFR7950 EFR7951
22,5" BPW TSB4312 ECO DISC	EFR7952 EFR7953
22,5" BPW TS2 4309 ECO DISC	EFR7954 EFR7955



ECO DISC (g/l)



ECO DISC (d/r)

(g/l) : Gauche/Left (d/r) : Droit/Right

VUE D'ENSEMBLE ÉTRIER RE-MANUFACTURÉ BENDIX
OVERVIEW OF REMANUFACTURED CALIPERS BENDIX



19,5" BENDIX ADB 3700

EFR6900 EFR6901

19,5" BENDIX ADB 3700

EFR6902 EFR6903

22,5" BENDIX ADB 4300

EFR7900 EFR7901



ADB 3700/4300 (g/l)



ADB 3700/4300 (d/r)

VUE D'ENSEMBLE ÉTRIER RE-MANUFACTURÉ BREMBO
OVERVIEW OF REMANUFACTURED CALIPERS BREMBO

19,5" BREMBO HD19

520.5320.12 520.5320.22

19,5" BREMBO HD19

520.5320.32 520.5320.42

22,5" BREMBO HD22.130

520.5310.10 520.5310.20

22,5" BREMBO HD22.106

520.5360.12 520.5360.22



HD 19 (g/l)

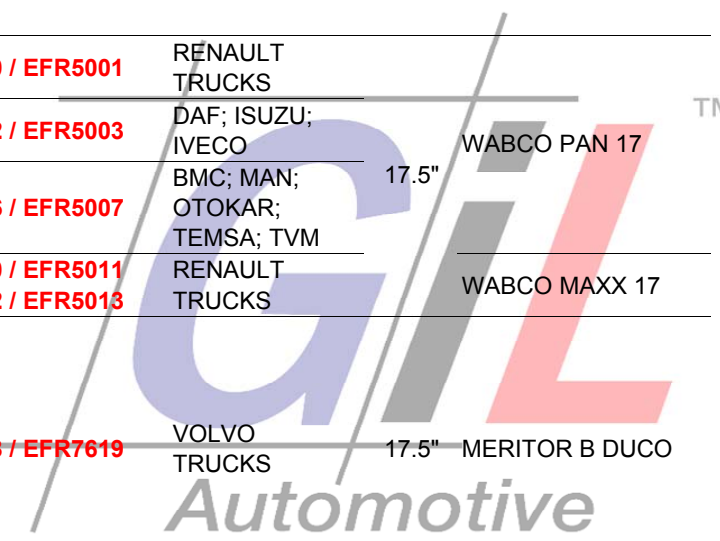


HD 22 (d/r)

RECHERCHE PLAQUETTES DE FREIN PAR DIMENSIONS BRAKE PADS RESEARCH BY SIZE



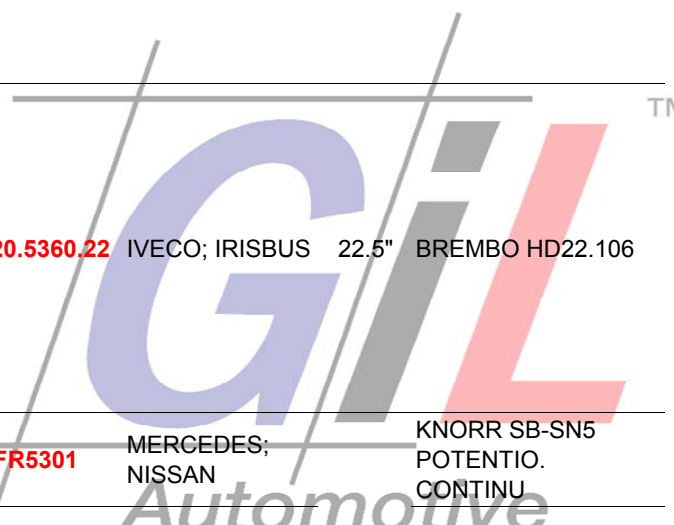
Width (mm)	Height (mm)	IMAGE / DRAWING	W.V.A ALTN. (FMSI)	Part Number	Dimensions (in)	Manufacturer / Brand
169,5	98,0		29072	2907203	19.5"	IVECO; IRISBUS BREMBO HD19
						520.5320.12 / 520.5320.22 520.5320.32 / 520.5320.42
175,5	85,6		29088 29091 29285 29144 (8727-D1518)	2928502 2928503 2928504 CVP032K	17.5"	RÉNAULT TRUCKS DAF; ISUZU; IVECO BMC; MAN; OTOKAR; TEMSA; TVM WABCO PAN 17 WABCO MAXX 17
175,5	88,8		29136	2913606	17.5"	VOLVO TRUCKS MERITOR B DUCO
175,7	82,5		29055 29057	2905503	17.5"	MAN WABCO 1000 V-G



RECHERCHE PLAQUETTES DE FREIN PAR DIMENSIONS BRAKE PADS RESEARCH BY SIZE



Width (mm)	Height (mm)	IMAGE / DRAWING	W.V.A ALTN. (FMSI)	Part Number	Part Number	Vehicle / Wheel	Brand / Model
179,6	106,0		29075 29074	2907503	520.5310.10 / 520.5310.20	IVECO; IRISBUS 22.5"	BREMBO HD22.130
179,6	106,0		29186 29074	2918602	520.5360.12 / 520.5360.22	IVECO; IRISBUS 22.5"	BREMBO HD22.106
185,0	84,0		29183 29148 29115 (D1995-9225)	2918302	EFR5300 / EFR5301 EFR5302 / EFR5303 EFR5304 / EFR5305	MERCEDES; NISSAN GIGANT SAE; MERCEDES 17.5"	KNORR SB-SN5 POTENTIO. CONTINU KNORR SB-SN5 POTENTIO. O/F KNORR SB-SN5 POTENTIO. CONTINU VIS
204,6	95,5		29134	2913401 TU+	EFR6124 / EFR6125	MERCEDES 19.5"	WABCO 1300 V-G



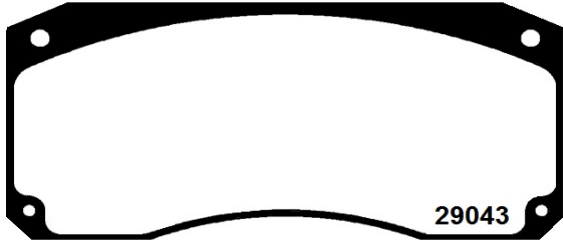
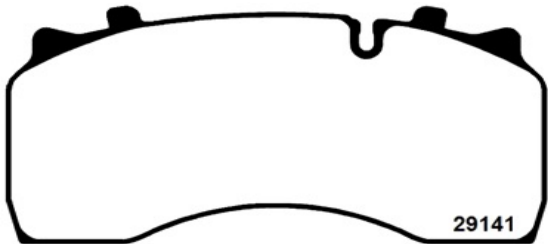
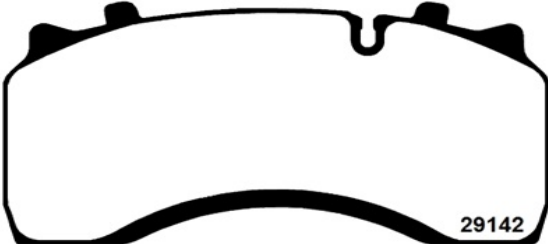
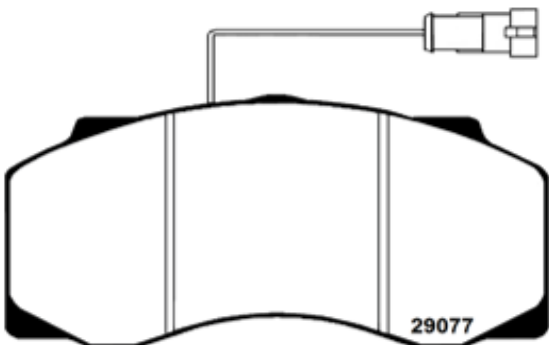
RECHERCHE PLAQUETTES DE FREIN PAR DIMENSIONS BRAKE PADS RESEARCH BY SIZE

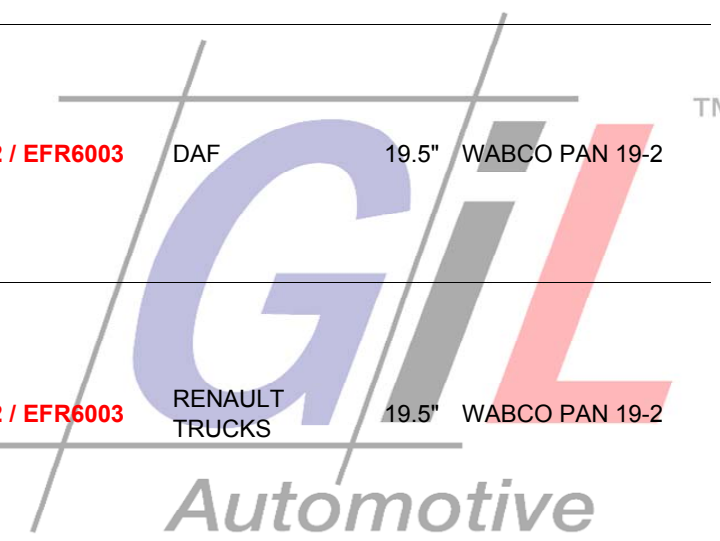


IMAGE / DRAWING

W.V.A
ALTN.
(FMSI)

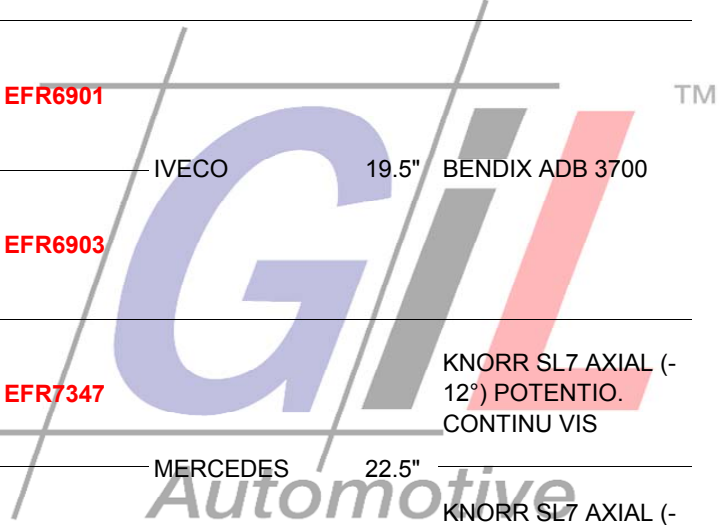


204,1	96,0		29043 29050 29051	2904303	EFR7652 / EFR7653	RENAULT TRUCKS	22.5" MERITOR D2
204,3	99,5		29141 (8726- D1517)	2914106	EFR6002 / EFR6003	DAF	19.5" WABCO PAN 19-2
204,3	99,6		29142 (8726- D1517)	29142 FCV1389	EFR6002 / EFR6003	RENAULT TRUCKS	19.5" WABCO PAN 19-2
204,6	106,0		29077 29092	2907702	EFR5004 / EFR5005	DAF	19.5" WABCO 1600 V-G



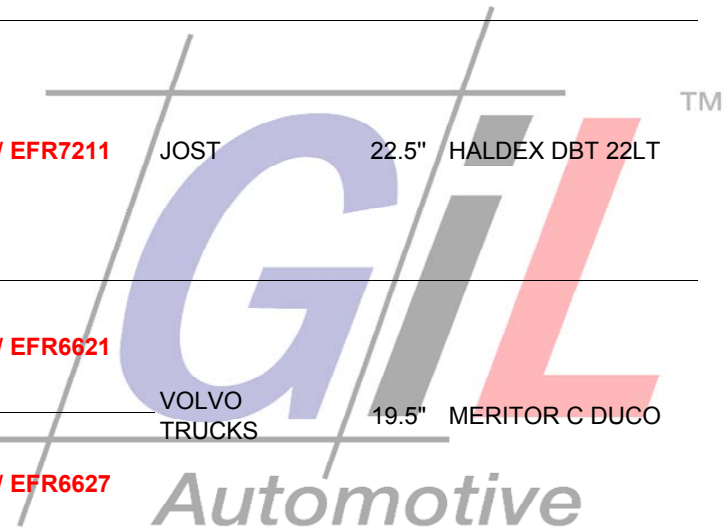
RECHERCHE PLAQUETTES DE FREIN PAR DIMENSIONS BRAKE PADS RESEARCH BY SIZE

		IMAGE / DRAWING	W.V.A ALTN. (FMSI)					
205,5	102,0		29124 29155 (8733- D1525)	2912405 CVP024K	EFR6650 / EFR6651	ROR	19.5"	MERITOR DX 195
205,6	109,8		29032	2903203	EFR6900 / EFR6901	IVECO	19.5"	BENDIX ADB 3700
207,6	113,7		29244 29245 29346	2924401 FCV4418PTS	EFR7346 / EFR7347	MERCEDES	22.5"	KNORR SL7 AXIAL (- 12°) POTENTIO. CONTINU VIS
210,0	93,2		29147 29181 29207	2918100604 TU- 2918101 TU+	EFR6200 / EFR6200	RENAULT TRUCKS; VOLVO TRUCKS	19.5"	HALDEX DB 19
					EFR6201 / EFR6201	GIGANT SAE		

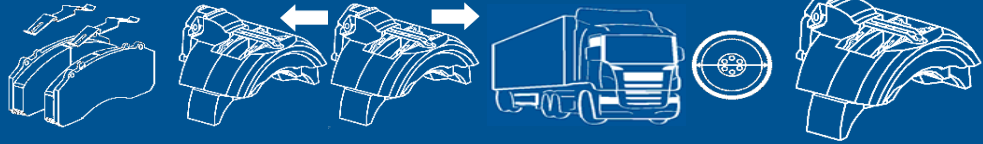
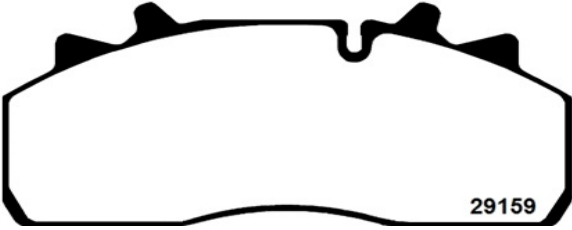
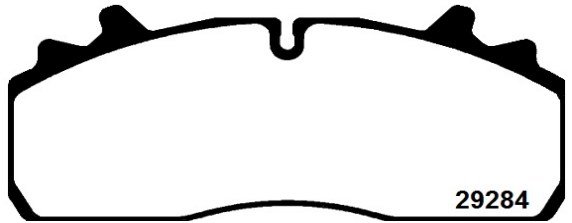
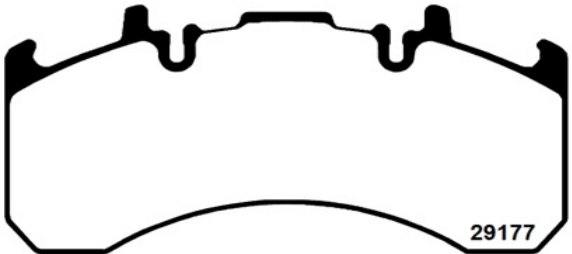
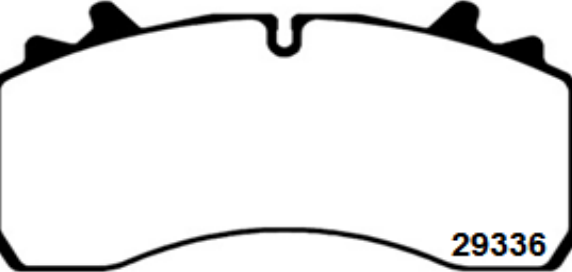


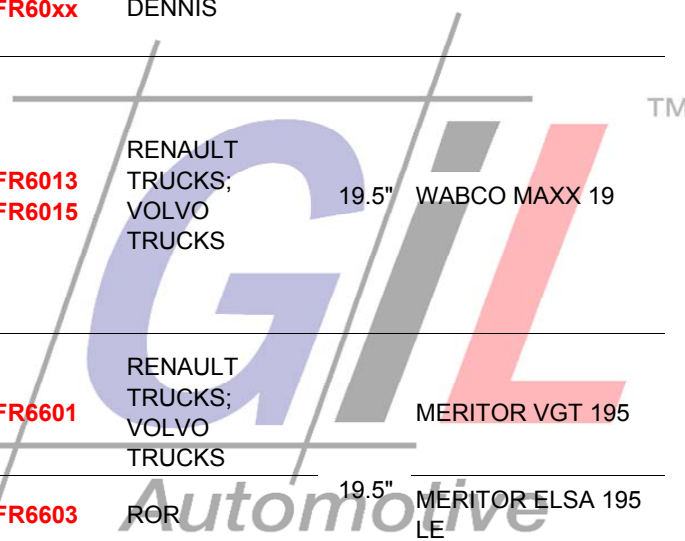
RECHERCHE PLAQUETTES DE FREIN PAR DIMENSIONS BRAKE PADS RESEARCH BY SIZE

		IMAGE / DRAWING	W.V.A ALTN. (FMSI)					
210,0	93,8		29175 29195 29274 29294	29175 FCV4420B	EFR7204 / EFR7204	GIGANT SAE; SMB	22.5"	HALDEX DB 22LT
					EFR7206 / EFR7207	SAF		HALDEX DBT 22LT
210,0	93,8		29340	293400956	EFR7210 / EFR7211	JOST	22.5"	HALDEX DBT 22LT
210,0	102,2		29137	2913706	EFR6620 / EFR6621	VOLVO TRUCKS	19.5"	MERITOR C DUCO
					EFR6626 / EFR6627			
210,3	102,0		29227 29316	2922701	EFR6950 / EFR6951	BPW	19.5"	BPW ECO DISC TSB 3709



RECHERCHE PLAQUETTES DE FREIN PAR DIMENSIONS BRAKE PADS RESEARCH BY SIZE

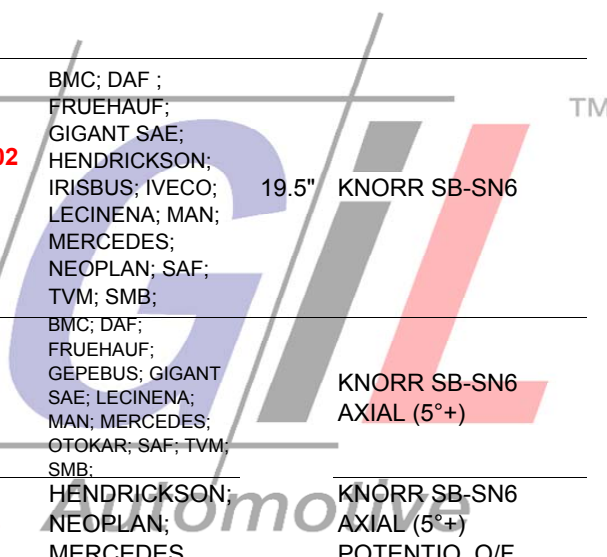
IMAGE / DRAWING		W.V.A ALTN. (FMSI)				
210,5	92,5	 29159 29126 (8556- D1438)	2931301 2931302	EFR6004 / EFR6005 <hr/> EFR6006 / EFR6007 <hr/> EFR60xx / EFR60xx	DAF <hr/> GIGANT SAE; SAF; SCHMITZ; VALX <hr/> DENNIS	19.5" WABCO PAN 19-1 Plus
210,6	90,6	 29284	2928401 CVP116K	EFR6012 / EFR6013 EFR6014 / EFR6015	RENAULT TRUCKS; VOLVO TRUCKS <hr/> RENAULT TRUCKS; VOLVO TRUCKS	19.5" WABCO MAXX 19
210,6	99,9	 29177 29169	2917705 CVP095K	EFR6600 / EFR6601 <hr/> EFR6602 / EFR6603 <hr/> EFR6656 / EFR6657	ROR <hr/> VOLVO TRUCKS	MERITOR VGT 195 <hr/> 19.5" MERITOR ELSA 195 LE <hr/> MERITOR ELSA 195 AXIAL
210,6	109,3	 29336 29290 29162 (D1777- 9007)	2933601	EFR7002 / EFR7003 <hr/> EFR70xx / EFR70xx	GIGANT SAE; SAF; SCHMITZ <hr/> VALX	22.5" WABCO PAN 22-1



RECHERCHE PLAQUETTES DE FREIN PAR DIMENSIONS BRAKE PADS RESEARCH BY SIZE



W	H	IMAGE / DRAWING	W.V.A ALT. (FMSI)					
210,6	109,3		29162 29290 29336 (D1777-9007)	2933606	EFR70xx / EFR70xx	SCHMITZ	22.5"	WABCO MAXX 22T
210,7	92,4		29095 29093 29094 29096 29197	CVP036K	IDEM 2932001 2932002 2932003 2932004 2932005 2936101	BMC; DAF ; FRUEHAUF; GIGANT SAE; HENDRICKSON; IRISBUS; IVECO; LEGINENA; MAN; MERCEDES; NEOPLAN; SAF; TVM; SMB;	19.5"	KNORR SB-SN6
					EFR6300 / EFR6301	BMC; DAF; FRUEHAUF; GEPEBUS; GIGANT SAE; LECINENA; MAN; MERCEDES; OTOKAR; SAF; TVM; SMB;		KNORR SB-SN6 AXIAL (5°+)
210,7	92,3		29095 29093 29094 29096 29197 29287 29320 29361	2932001 2932002 2932003 2932004 2932005 2936101	EFR6304 / EFR6305	HENDRICKSON; NEOPLAN; MERCEDES		KNORR SB-SN6 AXIAL (5°+) POTENTIO. O/F
					EFR6306 / EFR6307	HENDRICKSON	19.5"	KNORR SB-SN6 AXIAL (5°+) POTENTIO. CONTINU
					EFR6310 / EFR6311	IVECO		KNORR SB-SN6 AXIAL (5°+)
					EFR6312 / EFR6313	IRISBUS; IVECO		KNORR SB-SN6 AXIAL (0°)
					EFR6314 / EFR6315	MAN		KNORR SB-SN6 AXIAL (5°+) POTENTIO. CONTINU VIS
					EFR6316 / EFR6317	HENDRICKSON		KNORR SB-SN6 AXIAL (5°+) POTENTIO. CONTINU CLIP



RECHERCHE PLAQUETTES DE FREIN PAR DIMENSIONS BRAKE PADS RESEARCH BY SIZE



Width (mm)	Height (mm)	Image / Drawing	W.V.A. ALTN. (FMSI)	Part Number	Code	Brand	Other Info
210,7	92,5		29361	2936101	EFR6304 / EFR6305	MERCEDES	KNORR SB-SN6 AXIAL (5°+) POTENTIO. O/F
					EFR6306 / EFR6307	MERCEDES	KNORR SB-SN6 AXIAL (5°+) POTENTIO. CONTINU
210,7	107,1		29269 29158 29194 (8479-D1369)	2926900604 2926901	EFR6308 / EFR6309	LECINENA; MERCEDES; SAF; SCHMITZ	22.5" KNORR SK7
210,7	108,0		29257	292570539	EFR6308 / EFR6309	LECINENA; MERCEDES; SAF; SCHMITZ	22.5" KNORR SK7
210,8	92,5		29306 29268 29265 29165	2930601	EFR6300 / EFR6301 EFR6302 / EFR6303	BPW	KNORR SB-SN6 AXIAL (5°+) 19.5" KNORR SB-SN6 AXIAL (15°+)



RECHERCHE PLAQUETTES DE FREIN PAR DIMENSIONS BRAKE PADS RESEARCH BY SIZE

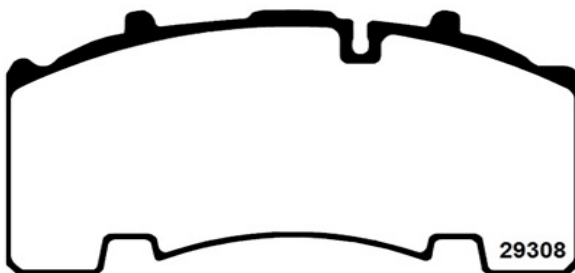


IMAGE / DRAWING

W.V.A
ALTN.
(FMSI)



210,8 108,0



29308
29271
29264
29171

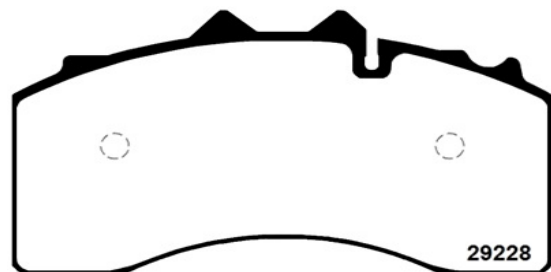
2930801
CVP094K

EFR6308 / EFR6309

BPW

22.5" KNORR SK7

210,8 114,5



29228
29317
29355

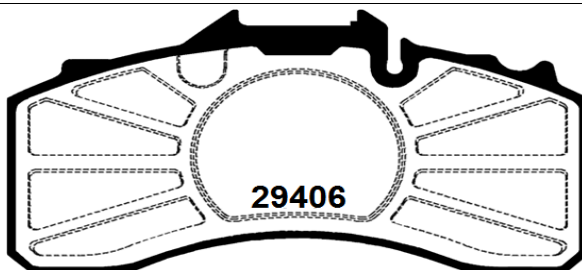
2922800604
2922801

EFR7950 / EFR7951

BPW

22.5" BPW ECO DISC TSB
4309

210,9 90,6
103,5



29405
29406

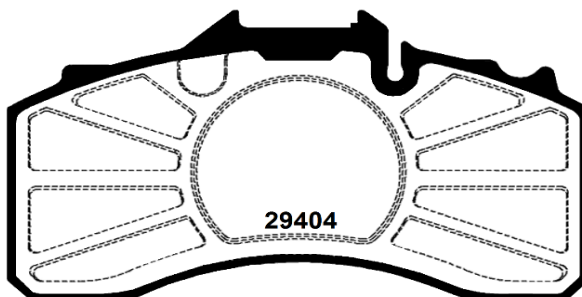
2940501

EFR6952 / EFR6953

BPW

19.5" BPW ECO DISC TS2
3709

210,9 104,1
117,0



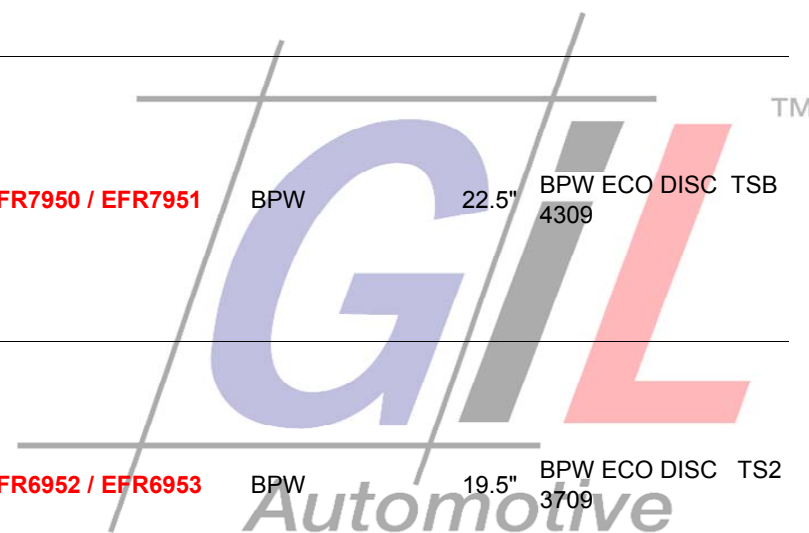
29403
29404

2940301




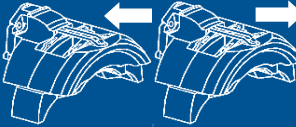



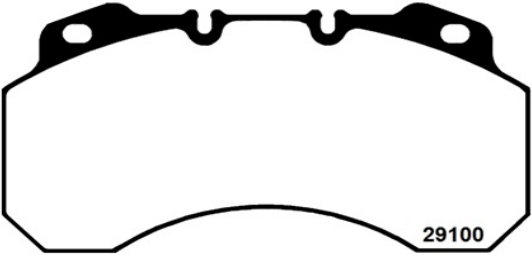
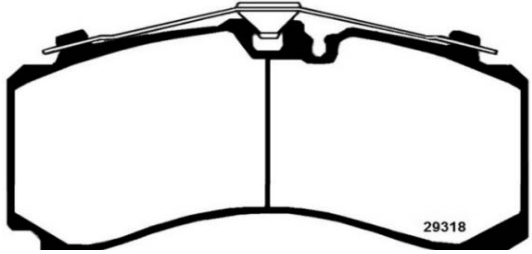
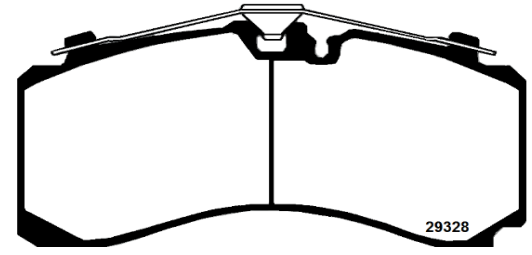

EFR7954 / EFR7955

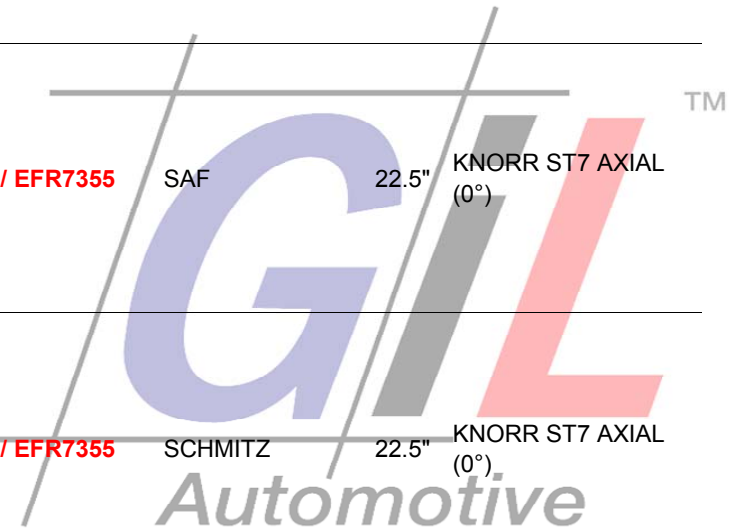
BPW

22.5" BPW ECO DISC TS2
4309

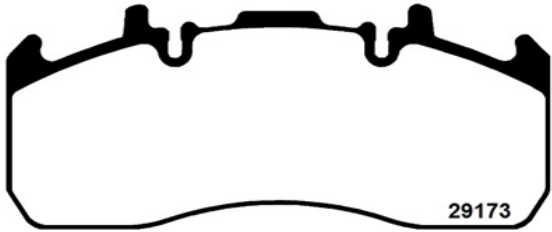
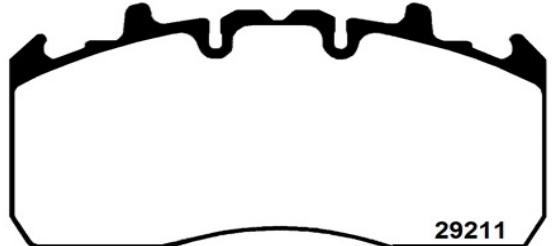
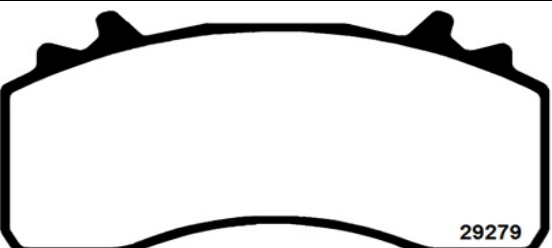
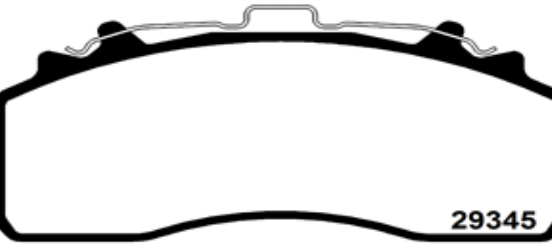


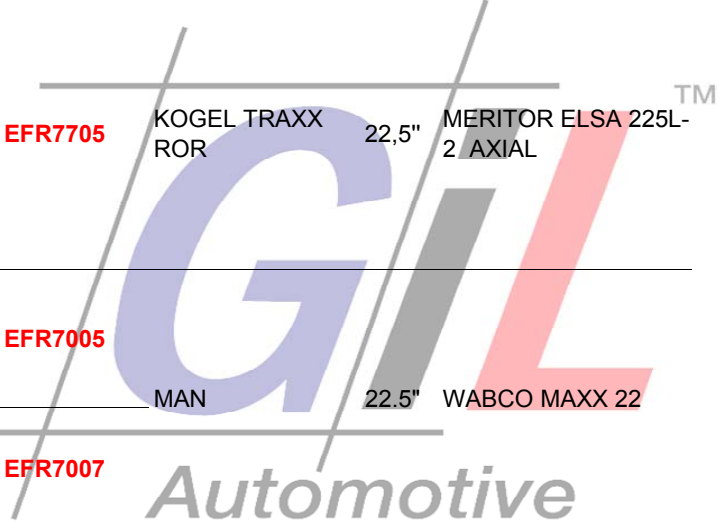
RECHERCHE PLAQUETTES DE FREIN PAR DIMENSIONS BRAKE PADS RESEARCH BY SIZE

 	IMAGE / DRAWING	W.V.A ALTN. (FMSI)	 			
213,6 111,6		29100 29099	2910004	EFR6654 / EFR6655	GEPEBUS; NISSAN; RENAULT TRUCKS	19.5" MERITOR C LISA
215,0 108,5		29318 29319	2931801 FCV4725PTS	EFR7354 / EFR7355	SAF	22.5" KNORR ST7 AXIAL (0°)
215,0 108,5		29328 29329	2932801 FCV4736PTS	EFR7354 / EFR7355	SCHMITZ	22.5" KNORR ST7 AXIAL (0°)
216,0 96,9		29151	2915102	EFR7628 / EFR7629	VOLVO TRUCKS	22.5" MERITOR LE DUCO



RECHERCHE PLAQUETTES DE FREIN PAR DIMENSIONS BRAKE PADS RESEARCH BY SIZE

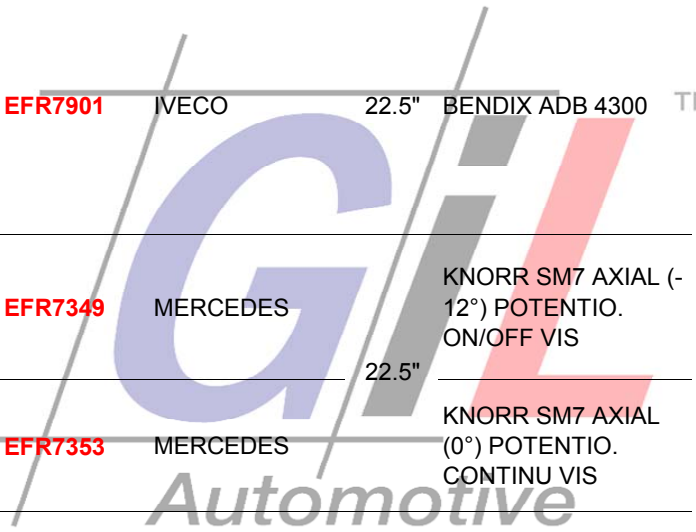
IMAGE / DRAWING		W.V.A ALTN. (FMSI)				
216,1	96,8	 29173 29203 29272	2917300604 2917301 2927201 CVP100K	EFR7680 / EFR7681 EFR7680R / EFR7681R EFR7690 / EFR7691 EFR7690R / EFR7691R	FAST; RENAULT TRUCKS VOLVO TRUCKS	22.5" MERITOR ELSA 225-1 AXIAL
216,1	110,2	 29211 29291	2921101	EFR7704 / EFR7705	KOGEL TRAXX ROR MAN	22.5" MERITOR ELSA 225L-2 AXIAL
217,5	107,6	 29279 29223 29337	2927900604 2927901	EFR7004 / EFR7005 EFR7006 / EFR7007	MAN	22.5" WABCO MAXX 22
220,5	107,6	 29315 29345	29315FLE1749 2931501	EFR70XX / EFR70XX	MERCEDES	22.5" WABCO MAXX 22L



RECHERCHE PLAQUETTES DE FREIN PAR DIMENSIONS BRAKE PADS RESEARCH BY SIZE



		IMAGE / DRAWING	W.V.A ALTN. (FMSI)					
235,5	109,0		29180	29180XX	EFR77XX / EFR77XX	APPLICATION SPECIALE	22.5"	MERITOR DX225
240,7	124,8		29011	2901105	EFR7900 / EFR7901	IVECO	22.5"	BENDIX ADB 4300 TM
244,6	113,7		29246	2924601	EFR7348 / EFR7349	MERCEDES	22.5"	KNORR SM7 AXIAL (-12°) POTENTIO. ON/OFF VIS
			29247					
29300								
29301								
29347								
29353								
29354								
247,0	115,3		29127 29267	29267xx	EFR7952 / EFR7953	BPW	22.5"	BPW ECO DISC TSB 4312
247,5	105,0		29143	2914302	EFR7200 / EFR7200	SMB	22.5"	HALDEX DB 22
			29120		EFR7201 / EFR7201	SMB		
			29176		EFR7202 / EFR7202	FRUEHAUF		
			29185		EFR7203 / EFR7203	FRUEHAUF		
			(8735-		EFR7208 / EFR7208	GIGANT SAE		
			D1527)		EFR7209 / EFR7209	SAF		

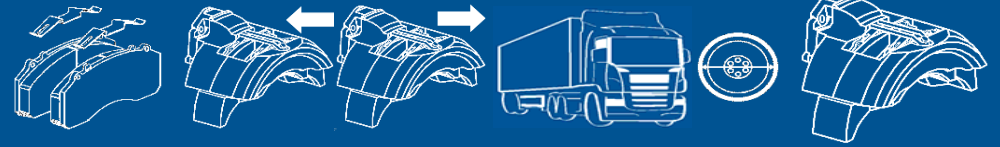


RECHERCHE PLAQUETTES DE FREIN PAR DIMENSIONS BRAKE PADS RESEARCH BY SIZE

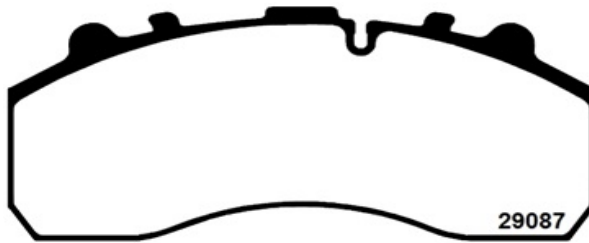


IMAGE / DRAWING

W.V.A
ALTN.
(FMSI)



247,5 107,6



29059
29042
29061
29087
29105
29108
29179
29196
29201
29202
(8323-
D1203)

2920200604
CVP020K

IDEM 2927801/02

BERKHOF VDL;
BMC; BOVA;
DAF ; DENNIS;
EVO BUS;
FAST;
FRUEHAUF;
GIGANT SAE;
HENDRICKSON;
HEULIEZ;
IRISBUS;
IVECO;
KAROSA;
LECINENA;
MAN;
MERCEDES;
NEOPLAN; SAF;
SCANIA;
SCHMITZ;
SOLARIS;
TEMSA; SMB;
VAN HOOL;
VDL;

22,5" KNORR SB-SN7

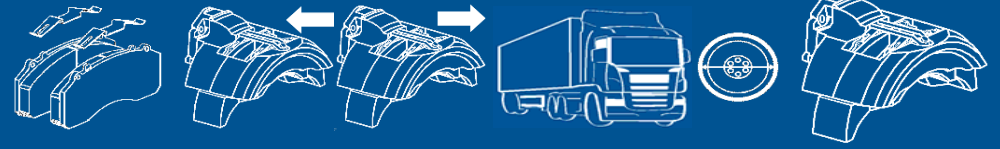


RECHERCHE PLAQUETTES DE FREIN PAR DIMENSIONS BRAKE PADS RESEARCH BY SIZE

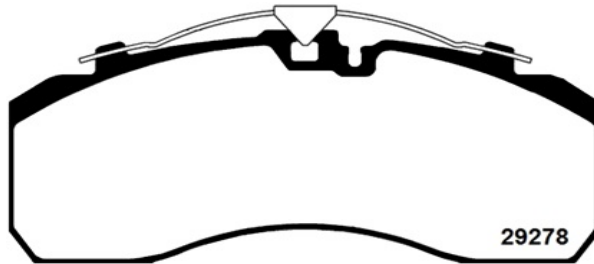


IMAGE / DRAWING

W.V.A
ALTN.
(FMSI)



247,5 109,5



29059
29042
29061
29087
29105
29108
29179
29196
29201
29202
29253
29278
(8323-
D1203)

2927801
2927802
292530539

EFR7300 / EFR7301

BERKHOF VDL;
BOVA; EVO BUS;
GIGANT SAE;
HEULIEZ;
IRISBUS; IVECO;
KAROSA;
MERCEDES; SAF;
SCHMITZ; SMB;
VDL

KNORR SB-SN7
AXIAL (-12°)

EFR7302 / EFR7303

BERKHOF VDL;
BOVA; DENNIS;
EVO BUS; FAST;
FRUEHAUF;
HENDRICKSON;
LECINENA; MAN;
NEOPLAN; SAF;
SCANIA;
SOLARIS; VDL

KNORR SB-SN7
AXIAL (0°)

EFR7304 / EFR7305

EVO BUS; IVECO;
MERCEDES; SMB;
TEMSA

22.5" KNORR SB-SN7 AXIAL (-
12°) POTENTIO.
CONTINU

EFR7306 / EFR7307

EVO BUS;
SCANIA

KNORR SB7 RADIAL
(86°+)

EFR7308 / EFR7309

DAF

KNORR SB-SN7 AXIAL
(0°) POTENTIO. O/F

EFR7310 / EFR7311

EVO BUS;
MERCEDES;
NEOPLAN; SAF;
SCANIA

KNORR SB-SN7 AXIAL
(0°) POTENTIO.
CONTINU VIS

EFR7312 / EFR7313

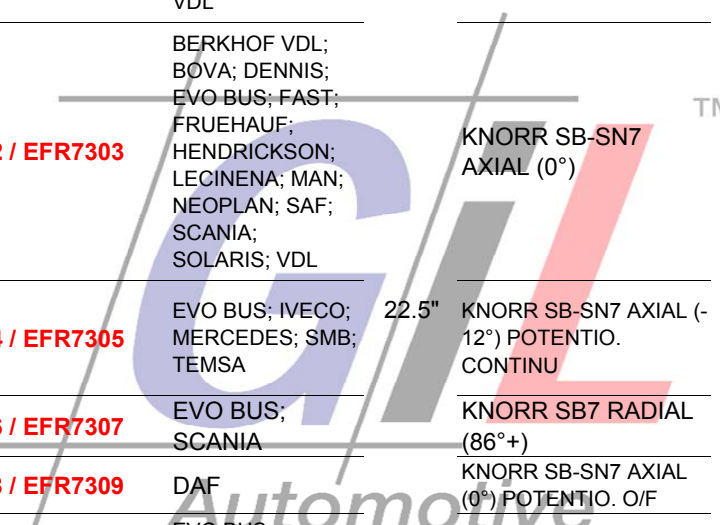
EVO BUS;
MERCEDES

KNORR SB-SN7 AXIAL
(12°+) POTENTIO.
CONTINU

EFR7314 / EFR7315

DENNIS; EVO
BUS; HEULIEZ;
IRISBUS;
NEOPLAN;
SCANIA

KNORR SB7 RADIAL
(93°+)



TM

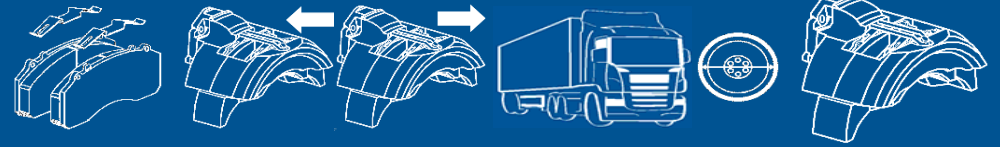
Automotive

RECHERCHE PLAQUETTES DE FREIN PAR DIMENSIONS BRAKE PADS RESEARCH BY SIZE

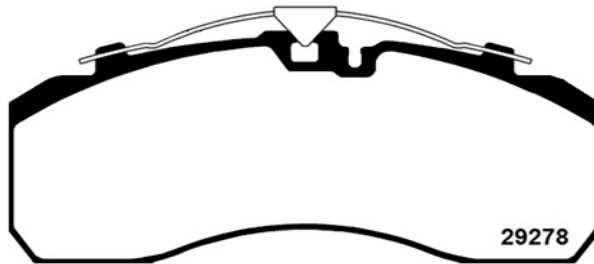


IMAGE / DRAWING

W.V.A
ALTN.
(FMSI)



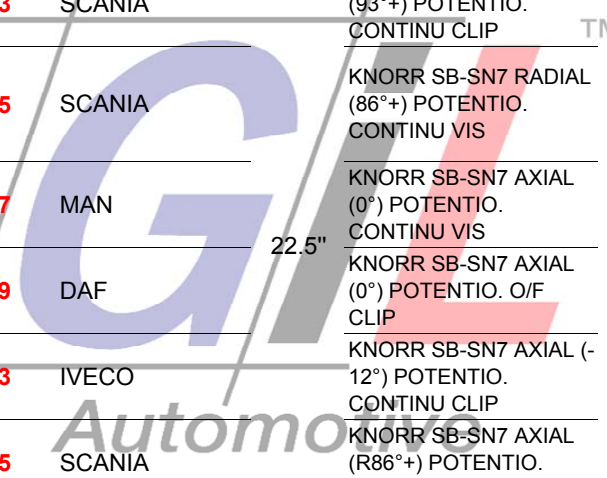
247,5 109,5



29059
29042
29061
29087
29105
29108
29179
29196
29201
29202
29253
29278
(8323-
D1203)

2927801
2927802
292530539

EFR7317 / EFR7316	EVO BUS; MAN; MERCEDES; NEOPLAN; SOLARIS	KNORR SB7 RADIAL (93°+) POTENTIO. CONTINU VIS
EFR7321 / EFR7320	SCANIA	KNORR SB-SN7 AXIAL (0°) POTENTIO. CONTINU CLIP
EFR7322 / EFR7323	SCANIA	KNORR SB7 RADIAL (93°+) POTENTIO. CONTINU CLIP
EFR7324 / EFR7325	SCANIA	KNORR SB-SN7 RADIAL (86°+) POTENTIO. CONTINU VIS
EFR7326 / EFR7327	MAN	KNORR SB-SN7 AXIAL (0°) POTENTIO. CONTINU VIS
EFR7328 / EFR7329	DAF	KNORR SB-SN7 AXIAL (0°) POTENTIO. O/F CLIP
EFR7332 / EFR7333	IVECO	KNORR SB-SN7 AXIAL (- 12°) POTENTIO. CONTINU CLIP
EFR7334 / EFR7335	SCANIA	KNORR SB-SN7 AXIAL (R86°+) POTENTIO. CONTINU CLIP
EFR7336 / EFR7337	MAN	KNORR SB-SN7 AXIAL (8°+)
EFR7340 / EFR7341	MAN	KNORR SB7 RADIAL (3°+) POTENTIO. CONTINU VIS
EFR7344 / EFR7345	FAST; MAN; NEOPLAN; VAN HOOL	KNORR SB-SN7 AXIAL (0°) POTENTIO. CONTINU VIS
EFR73xx / EFR73xx	DAF	KNORR SB-SN7 AXIAL (0°)



22.5"

RECHERCHE PLAQUETTES DE FREIN PAR DIMENSIONS BRAKE PADS RESEARCH BY SIZE

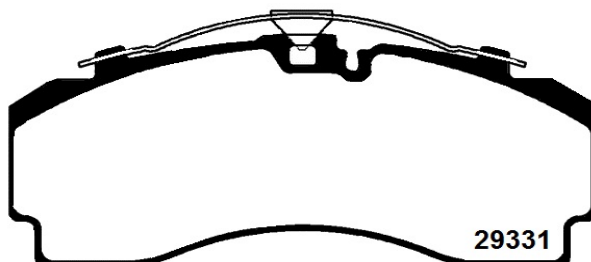


IMAGE / DRAWING

W.V.A
ALTN.
(FMSI)



247,5 107,6



29331

2933100604
PROTEC S-
2933101
2933102

EFR7302 / EFR7303

SCANIA

KNORR SB-SN7
AXIAL (0°)

EFR7308 / EFR7309

SCANIA

KNORR SB-SN7
AXIAL (0°)
POTENTIO. O/F

EFR7310 / EFR7311

IRIZAR

KNORR SB-SN7
AXIAL (0°)
POTENTIO.
CONTINU VIS

EFR7320 / EFR7321

IRIZAR; SCANIA

KNORR SB-SN7
AXIAL (0°)
POTENTIO.
CONTINU CLIP

EFR7322 / EFR7323

IRIZAR; SCANIA

KNORR SB7 RADIAL
(93°+) POTENTIO.
CONTINU CLIP

EFR7324 / EFR7325

IRIZAR

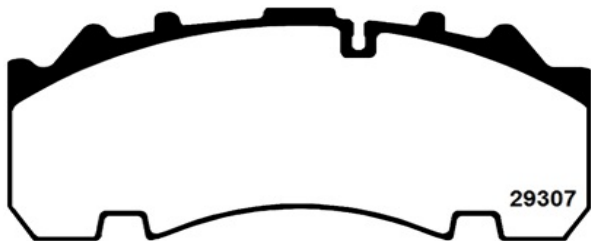
KNORR SB-SN7
RADIAL (86°+)
POTENTIO.
CONTINU VIS

EFR7334 / EFR7335

IRIZAR

KNORR SB-SN7
AXIAL (R86°+)
POTENTIO.
CONTINU CLIP

247,6 109,5



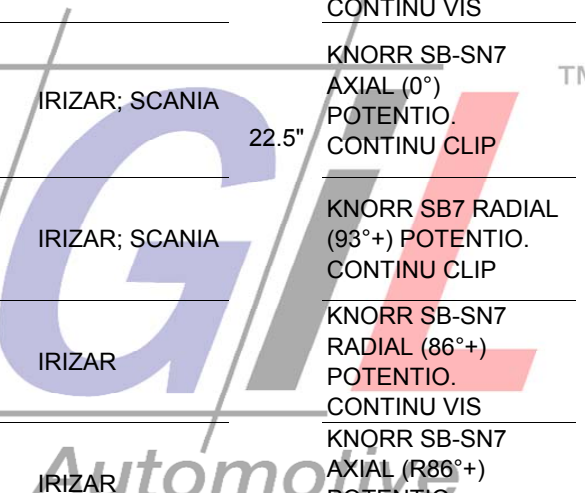
29167
29263
29270
29307

2930701
CVP093K

EFR7302 / EFR7303

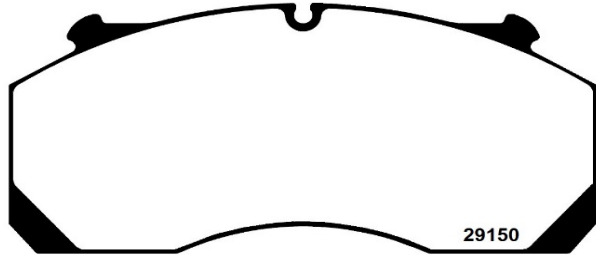
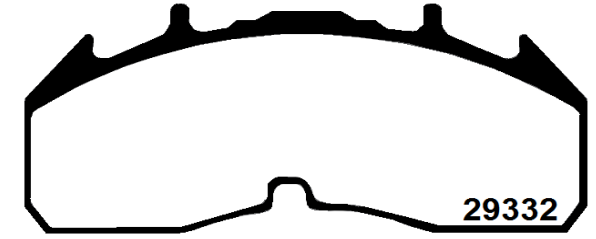
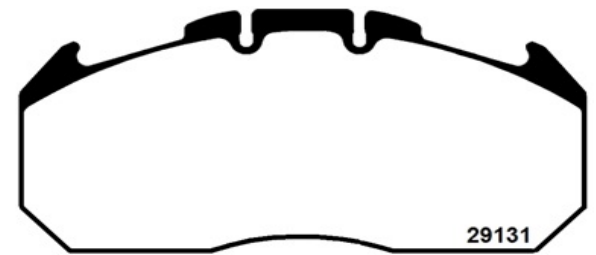
BPW

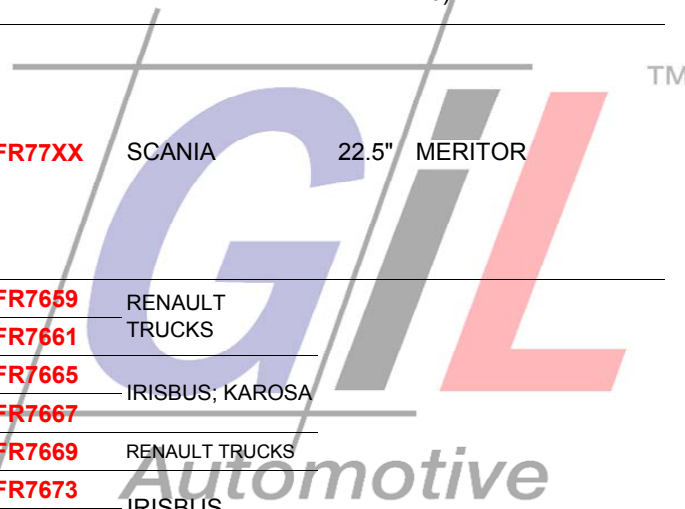
22.5" KNORR SB-SN7
AXIAL (0°)



RECHERCHE PLAQUETTES DE FREIN PAR DIMENSIONS BRAKE PADS RESEARCH BY SIZE

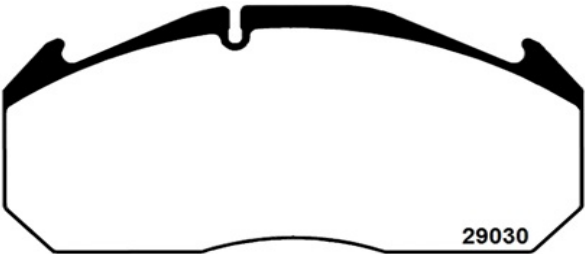
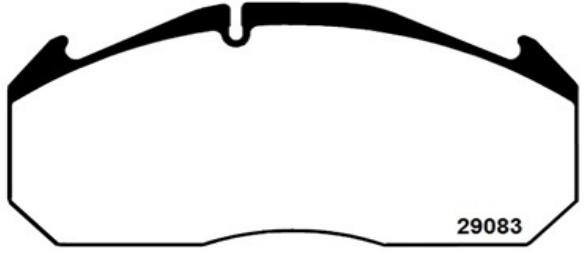
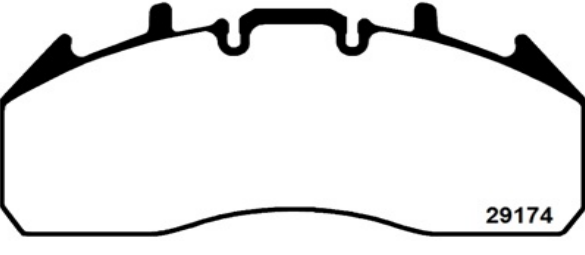



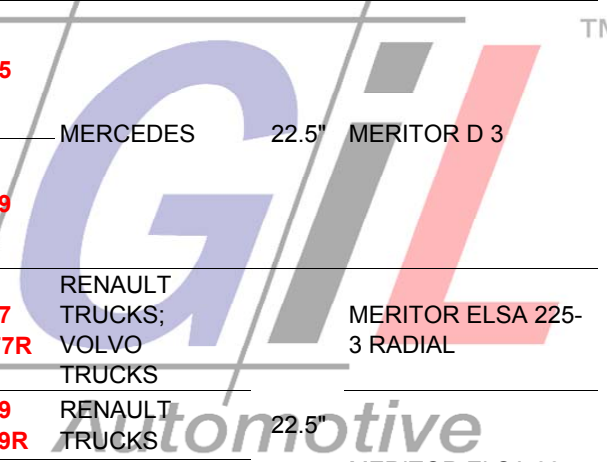
IMAGE / DRAWING	W.V.A ALTN. (FMSI)					
 <p>249,0 112,4</p> <p>29150</p>	29150 (8734-D1526)	2915001	EFR7670 / EFR7671	IRIBUS		MERITOR DX 225 (21-22)
			EFR7712 / EFR7713	IRIBUS	22.5"	MERITOR DX 225 (17-18)
			EFR7714 / EFR7715	IRIBUS		MERITOR DX 225 (15-16)
 <p>249,2 108,5</p> <p>29332</p>	29332	2933200604 2933201	EFR77XX / EFR77XX	SCANIA	22.5"	MERITOR
			EFR7658 / EFR7659	RENAULT TRUCKS		
			EFR7660 / EFR7661	RENAULT TRUCKS		
			EFR7664 / EFR7665	IRISBUS; KAROSA		
			EFR7666 / EFR7667	IRISBUS; KAROSA		
			EFR7668 / EFR7669	RENAULT TRUCKS		
			EFR7672 / EFR7673	IRISBUS		
 <p>249,5 118,1</p> <p>29131</p>	29131 29156 (8425-D1310)	2913103 2913105 2913115 CVP088K	EFR7674 / EFR7675	IRISBUS		
			EFR7684 / EFR7685	HEULIEZ; IRISBUS		
			EFR7692 / EFR7693	ROR	22.5"	MERITOR D ELSA 2
			EFR7694 / EFR7695	FAST; MAN; NEOPLAN		
			EFR7698 / EFR7699	FAST; MAN; NEOPLAN		
			EFR7700 / EFR7701	MAN; VAN HOOL		
			EFR7702 / EFR7703	MAN; VAN HOOL		
			EFR7706 / EFR7707	VOLVO TRUCKS		
			EFR7716 / EFR7717	MAN		
			EFR7718 / EFR7719	NEOPLAN; VAN HOOL		
EFR7720 / EFR7721	VAN HOOL					



RECHERCHE PLAQUETTES DE FREIN PAR DIMENSIONS BRAKE PADS RESEARCH BY SIZE

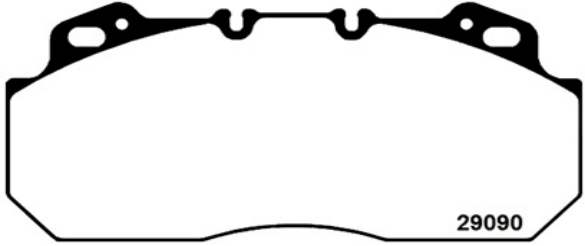
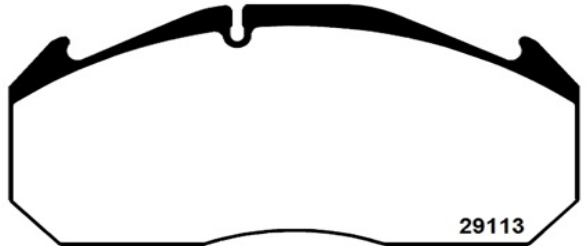


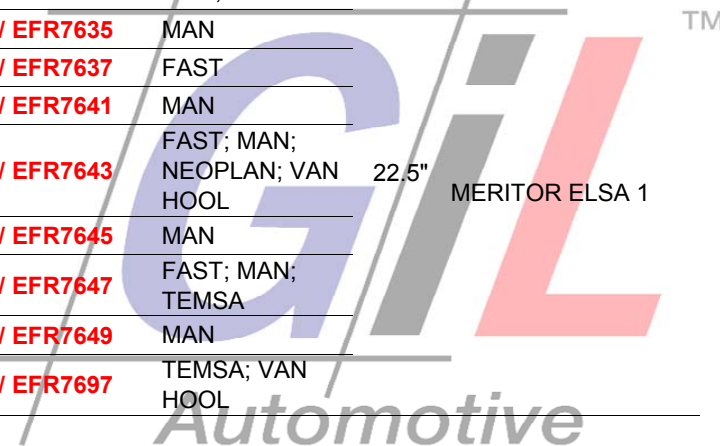
IMAGE / DRAWING	W.V.A ALTN. (FMSI)					
 <p>249,5 118,2</p> <p>29030</p>	29030 29083 29210 (8515- D1407)	2903007 2903009 2903024 CVP013K	EFR7602 / EFR7603 EFR7606 / EFR7607 EFR7638 / EFR7639	HEULIEZ; KAROSA; RENAULT TRUCKS EVO BUS; MERCEDES HEULIEZ; IRISBUS; RENAULT TRUCKS; TEMSA; VAN HOOL	22.5"	MERITOR D 3 MERITOR D 3 MERITOR ELSA 1
 <p>249,5 118,2</p> <p>29083</p>	29083 29030 29210	2908302	EFR7604 / EFR7605 EFR7608 / EFR7609	MERCEDES	22.5"	MERITOR D 3
 <p>249,6 106,9</p> <p>29174</p>	29174 29219 29226 29273 29334 (D1708- 8931)	2917400604 2917401 2927301 CVP101K	EFR7676 / EFR7677 EFR7676R / EFR7677R EFR7678 / EFR7679 EFR7678R / EFR7679R EFR7686 / EFR7687 EFR7688R / EFR7689R	RENAULT TRUCKS; VOLVO TRUCKS RENAULT TRUCKS HEULIEZ; IRISBUS VOLVO TRUCKS	22.5"	MERITOR ELSA 225- 3 RADIAL MERITOR ELSA 225- 3 AXIAL
 <p>249,6 111,2</p> <p>29125</p>	29277 29125 (8771- D1560)	2927705 CVP037K	EFR7616 / EFR7617 EFR7622 / EFR7623 EFR7624 / EFR7625 EFR7630 / EFR7631	ROR VOLVO TRUCKS ROR; VOLVO TRUCKS	22.5"	MERITOR D DUCO AXIAL MERITOR D DUCO AXIAL MERITOR D DUCO RADIAL MERITOR D DUCO AXIAL

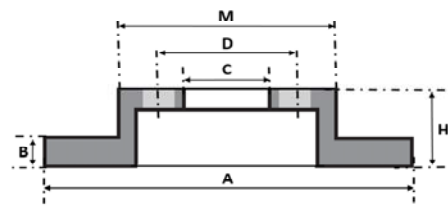


RECHERCHE PLAQUETTES DE FREIN PAR DIMENSIONS BRAKE PADS RESEARCH BY SIZE



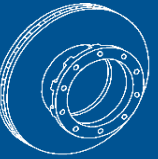
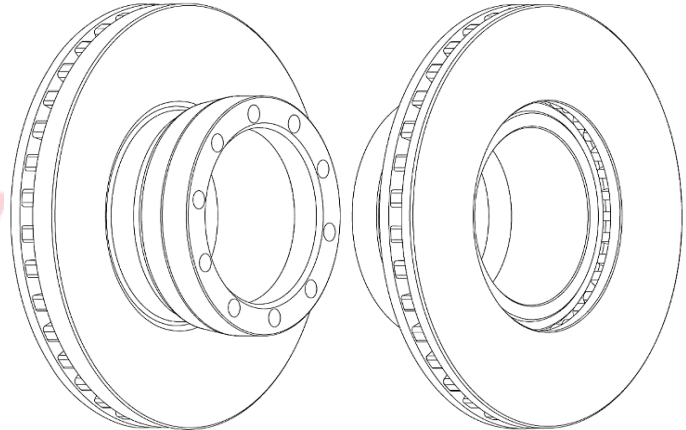
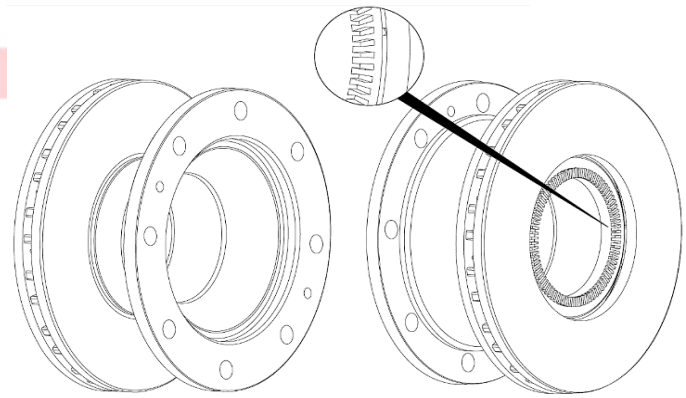


IMAGE / DRAWING	W.V.A ALTN. (FMSI)				
<div style="display: flex; justify-content: space-around;"> <div style="text-align: center;">  <p>29090</p> </div> </div>	29090 (8427- D1312)	<p>2909006</p> <p>2909009</p> <p>CVP023K</p>	<p>EFR7610 / EFR7611</p> <hr/> <p>EFR7612 / EFR7613</p> <hr/> <p>EFR7614 / EFR7615</p> <hr/> <p>EFR7600 / EFR7601</p> <hr/> <p>EFR7632 / EFR7633</p> <hr/> <p>EFR7634 / EFR7635</p> <hr/> <p>EFR7636 / EFR7637</p> <hr/> <p>EFR7640 / EFR7641</p> <hr/> <p>EFR7642 / EFR7643</p> <hr/> <p>EFR7644 / EFR7645</p> <hr/> <p>EFR7646 / EFR7647</p> <hr/> <p>EFR7648 / EFR7649</p> <hr/> <p>EFR7696 / EFR7697</p>	<p>FAST; HEULIEZ; IRISBUS; RENAULT TRUCKS</p> <hr/> <p>BERKHOF VDL; HEULIEZ; VOLVO TRUCKS</p> <hr/> <p>DENNIS</p> <hr/> <p>MAN</p> <hr/> <p>MAN; TEMSA</p> <hr/> <p>MAN</p> <hr/> <p>FAST</p> <hr/> <p>MAN</p> <hr/> <p>FAST; MAN; NEOPLAN; VAN HOOL</p> <hr/> <p>MAN</p> <hr/> <p>FAST; MAN; TEMSA</p> <hr/> <p>MAN</p> <hr/> <p>TEMSA; VAN HOOL</p>	<p>22.5" MERITOR D LISA</p> <hr/> <p>MERITOR D 3</p> <hr/> <p>22.5" MERITOR ELSA 1</p>
<div style="display: flex; justify-content: space-around;"> <div style="text-align: center;">  <p>29113</p> </div> </div>	29113 (8515- D1407)	<p>2911303</p> <p>2911307</p>			





RECHERCHE DISQUES DE FREIN PAR DIMENSIONS BRAKE DISC RESEARCH BY SIZE

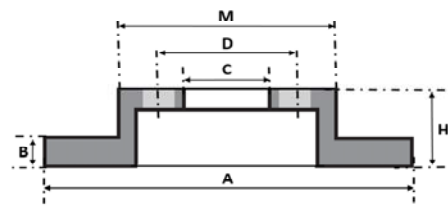
A	H	B	B min.	NB Trous/hole	D	C	M	FIXATION	KG	P V				ILLUSTRATIONS / DRAWINGS
324,0	102,0	30,0	24,0	10	158,0	135,0	184,0		13,80	V	MAN L2000 - 17,5" WABCO 1000 V-G		09.7164.10 FCR143A 93085300	
329,0	141,0	34,0	28,0	8	275,0	215,0	320,0	2	23,00	V	IVECO 110EL; 120EL - 17,5" WABCO PAN 17 (ABS+)		09.7804.60 FCR237A 93127400	





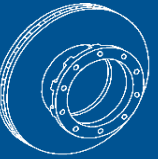
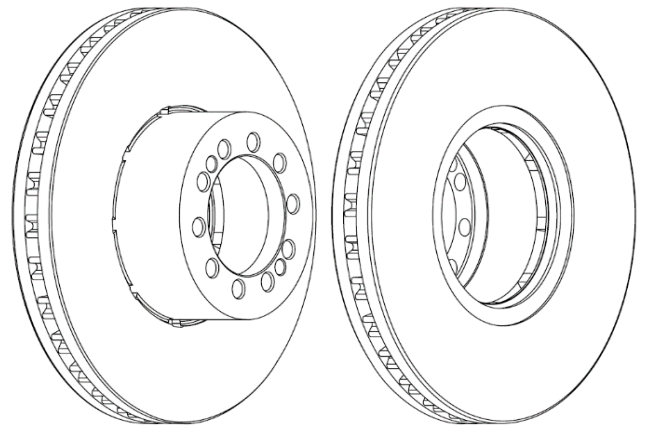
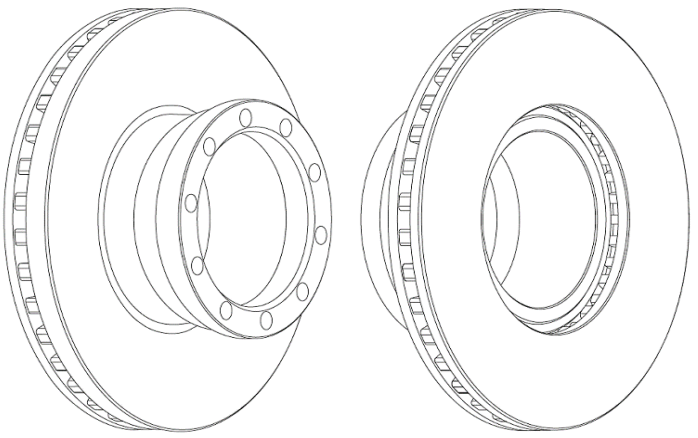
P:disque plein/solid disc

V:disque ventilé/vented disc

Les dessins de disque de frein proviennent/Brake disc drawing come from Federal Mogul



RECHERCHE DISQUES DE FREIN PAR DIMENSIONS BRAKE DISC RESEARCH BY SIZE

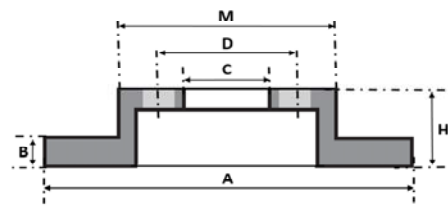
A	H	B	B min.	NB Trous/holes	D	C	M	FIXATION	KG	P V				ILLUSTRATIONS / DRAWINGS
330,0	80,0	34,0	28,0	10	118,0	95,0	165,5	2	14,90	V	RENAULT TRUCKS MIDLUM D SERIE - 17,5" WABCO PAN 17 (ABS-)	DF50001 09.9492.20 FCR218A 93192600		
330,0	104,0	34,0	30,0	10	158,0	135,0	135,0		16,40	V	MAN L2000; M2000 SERIES - 17,5" WABCO PAN 17 (ABS-)	09.8173.10 FCR146A 93085400		





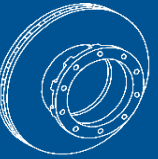
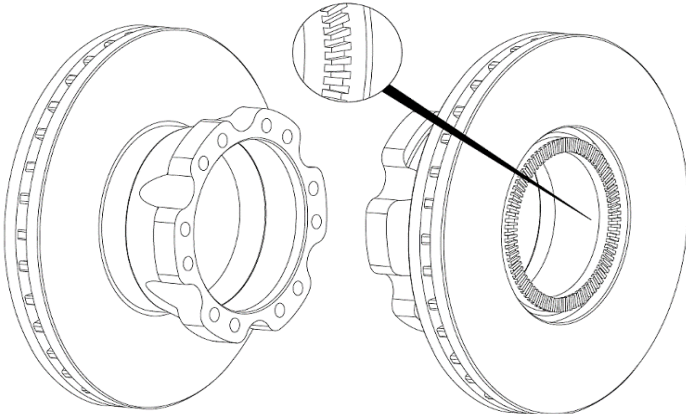

P:disque plein/solid disc

V:disque ventilé/vented disc

Les dessins de disque de frein proviennent/Brake disc drawing come from Federal Mogul



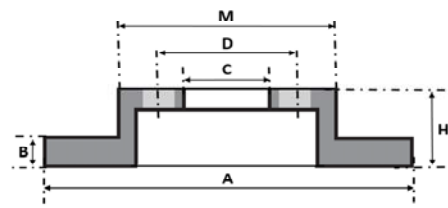
RECHERCHE DISQUES DE FREIN PAR DIMENSIONS BRAKE DISC RESEARCH BY SIZE

A	H	B	B min.	NB Trous/hole	D	C	M	FIXATION	KG	P V				ILLUSTRATIONS / DRAWINGS
330,0	119,0	34,0	28,0	12	175,0	150,0	204,0		17,00	V	DAF LF45 - 17,5" WABCO PAN 17	FCR226A	93187800	
330,0	119,0	34,0	28,0	18	175,0	150,0	206,0		17,00	V	DAF LF45 - 17,5" WABCO PAN 17	DF713891		



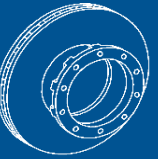
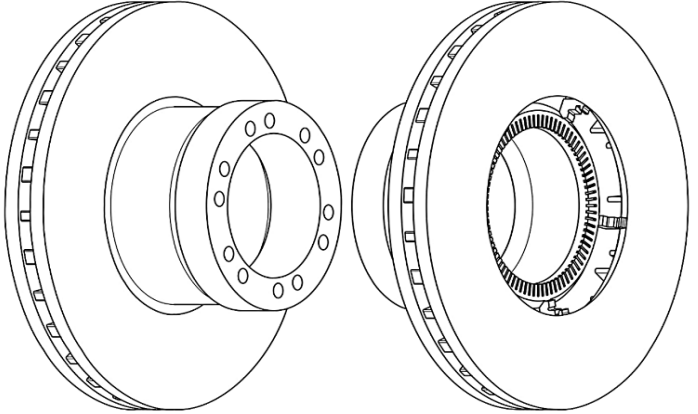
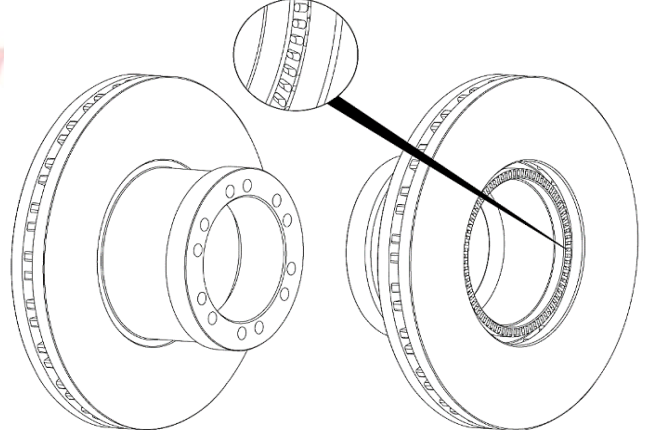


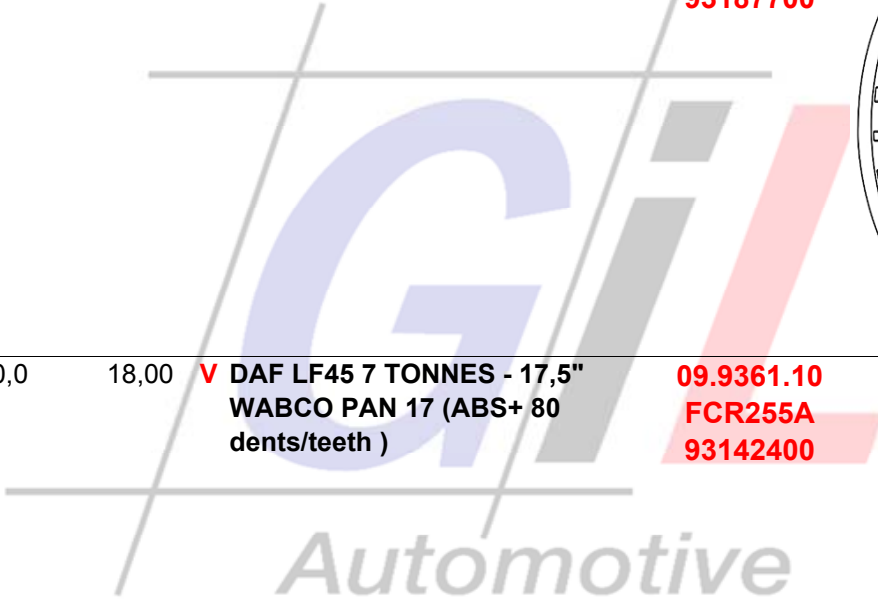
P:disque plein/solid disc
V:disque ventilé/vented disc

Les dessins de disque de frein proviennent/Brake disc drawing come from Federal Mogul



RECHERCHE DISQUES DE FREIN PAR DIMENSIONS BRAKE DISC RESEARCH BY SIZE

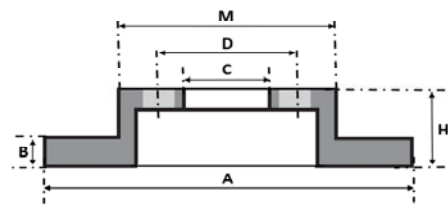
A	H	B	B min.	NB Trous/holes	D	C	M	FIXATION	KG	P V				ILLUSTRATIONS / DRAWINGS
330,0	123,0	34,0	28,0	12	138,0	117,0	170,0		17,60	V	DAF LF45 - 17,5" WABCO PAN 17 (ABS+)		09.E664.20 FCR350A 93187700	
330,0	123,0	34,0	28,0	12	138,0	117,0	170,0		18,00	V	DAF LF45 7 TONNES - 17,5" WABCO PAN 17 (ABS+ 80 dents/teeth)		09.9361.10 FCR255A 93142400	





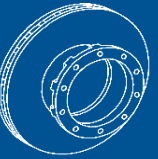
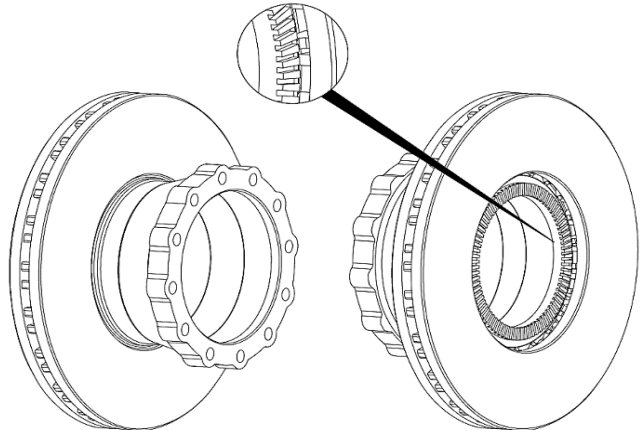
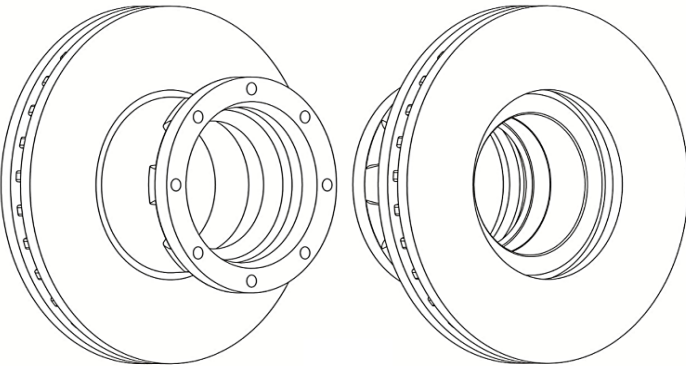
P:disque plein/solid disc

V:disque ventilé/vented disc

Les dessins de disque de frein proviennent/Brake disc drawing come from Federal Mogul



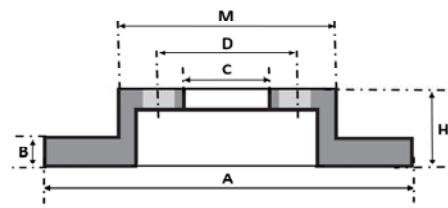
RECHERCHE DISQUES DE FREIN PAR DIMENSIONS BRAKE DISC RESEARCH BY SIZE

A	H	B	B min.	NB Trous/hole	D	C	M	FIXATION	KG	P V				ILLUSTRATIONS / DRAWINGS
330,0	124,0	34,0	28,0	12	180,0	157,0	205,0		17,11	V	MAN L2000 SERIES - 17,5"	WABCO PAN 17 (ABS+ 80 dents/teeth)	09.8172.10 FCR148A 93085500	
330,0	129,0	34,0	26,0	8	177,0	145,0	200,0		17,30	V	MAN L2000 SERIES - 17,5"	WABCO PAN 17	93127700 FCR216A	



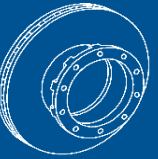
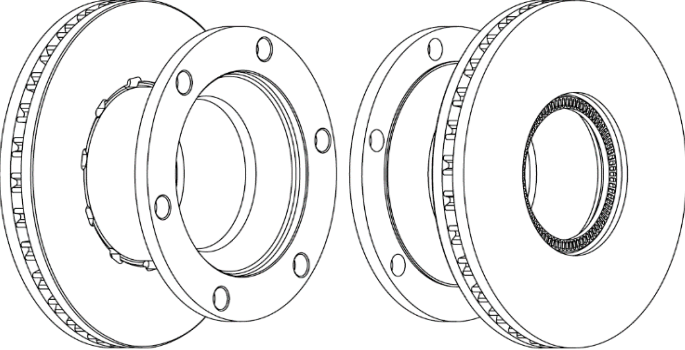
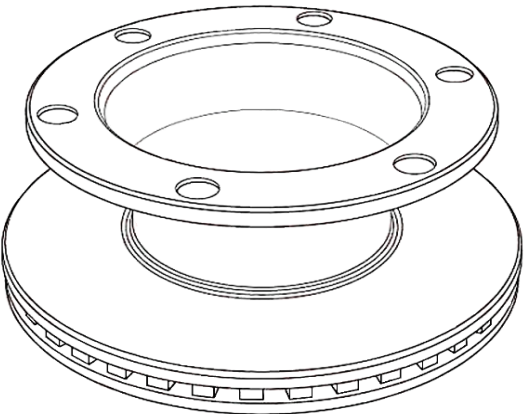


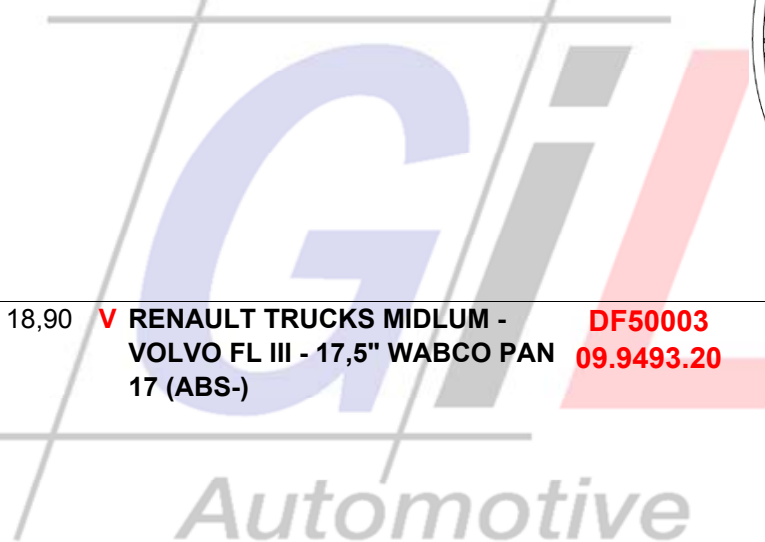
P:disque plein/solid disc
V:disque ventilé/vented disc

Les dessins de disque de frein proviennent/Brake disc drawing come from Federal Mogul



RECHERCHE DISQUES DE FREIN PAR DIMENSIONS BRAKE DISC RESEARCH BY SIZE

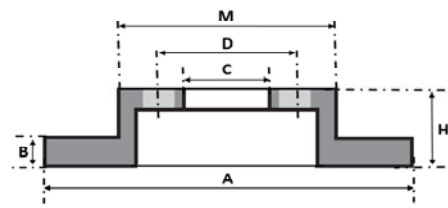
A	H	B	B min.	NB Trous/hole	D	C	M	FIXATION	KG	P V				ILLUSTRATIONS / DRAWINGS
330,0	137,0	34,0	28,0	6	245,0	194,0	280,0		20,00	V	RENAULT TRUCKS MIDLUM D SERIE - 17,5" WABCO PAN 17 (ABS+ 80 dents/teeth)		DF50002 09.9493.60 FCR219A 93192200	
330,0	137,0	34,0	28,0	6	245,0	194,0	280,0		18,90	V	RENAULT TRUCKS MIDLUM - VOLVO FL III - 17,5" WABCO PAN 17 (ABS-)		DF50003 09.9493.20	





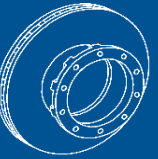
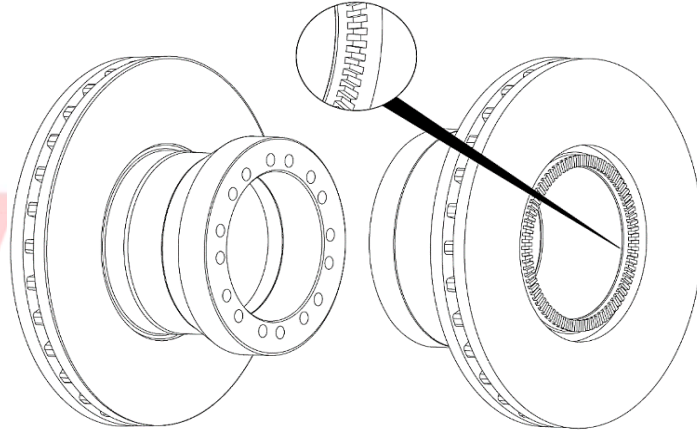
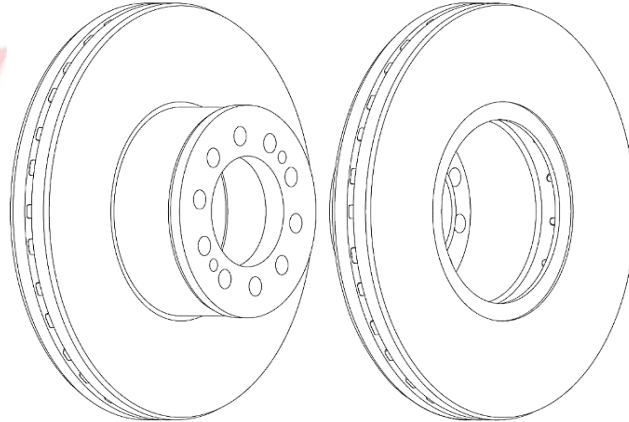
P:disque plein/solid disc

V:disque ventilé/vented disc

Les dessins de disque de frein proviennent/Brake disc drawing come from Federal Mogul



RECHERCHE DISQUES DE FREIN PAR DIMENSIONS BRAKE DISC RESEARCH BY SIZE

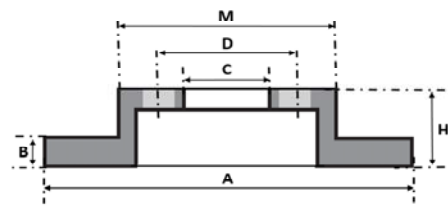
A	H	B	B min.	NB Trous/holes	D	C	M	FIXATION	KG	P V				ILLUSTRATIONS / DRAWINGS
330,0	143,5	34,0	28,0	16	155,0	133,0	195,0		19,20	V	DAF LF45 12 TONNES - 17,5"	WABCO PAN 17 (ABS+ 80 dents/teeth)	FCR256A 93142500	
335,0	93,0	34,0	26,0	10	122,0	90,0	170,9		16,50	V	MAN TGL - 17,5"	KNORR SB-SN5 (ABS-)	09.B564.10 FCR330A 93138000	





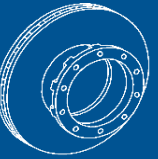
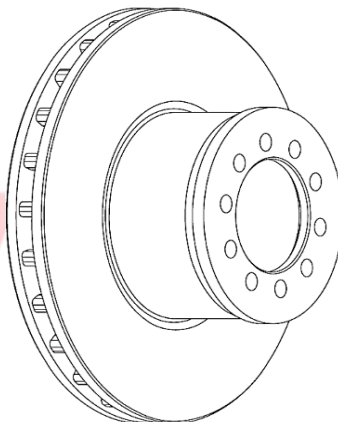
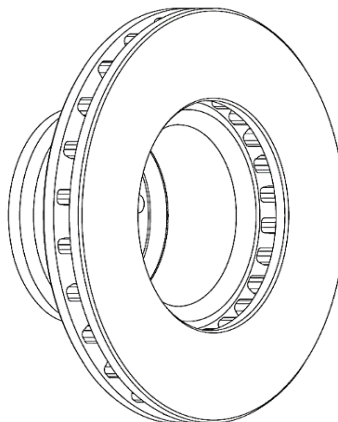
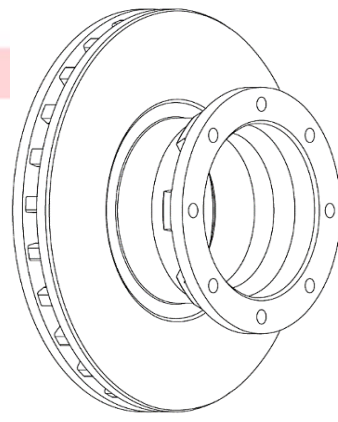
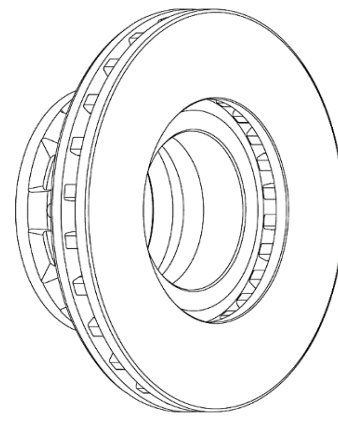
P:disque plein/solid disc

V:disque ventilé/vented disc

Les dessins de disque de frein proviennent/Brake disc drawing come from Federal Mogul



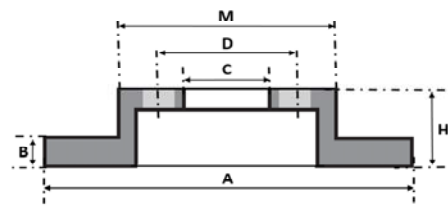
RECHERCHE DISQUES DE FREIN PAR DIMENSIONS BRAKE DISC RESEARCH BY SIZE

A	H	B	B min.	NB Trous/hole	D	C	M	FIXATION	KG	P V				ILLUSTRATIONS / DRAWINGS
335,0	102,5	34,0	28,0	10	120,0	91,5	175,0		14,90	V	MERCEDES ACCELO ATEGO -			 
											17,5" KNORR SB-SN5 (ABS-) -	09.8574.10	FCR186A 93101300	
335,0	111,0	34,0	28,0	8	177,0	145,0	204,0		15,80	V	MERCEDES ATEGO (5 TONNES) -			 
											17,5" KNORR SB-SN5 (ABS-) -	09.9181.10	FCR187A 93102300	



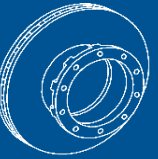


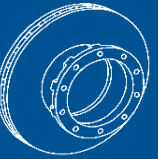
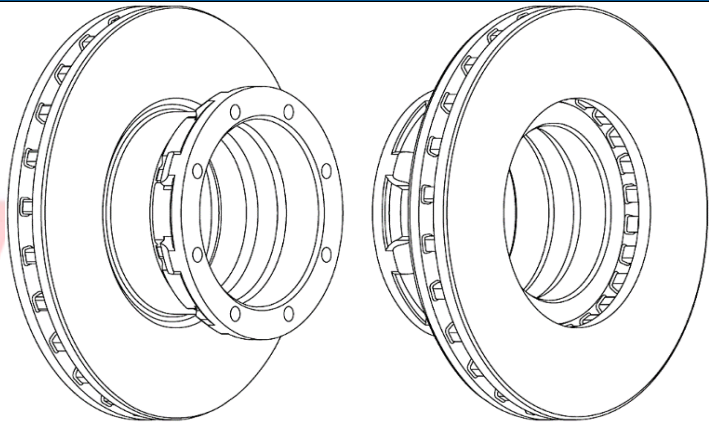


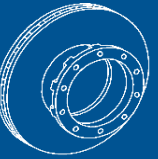
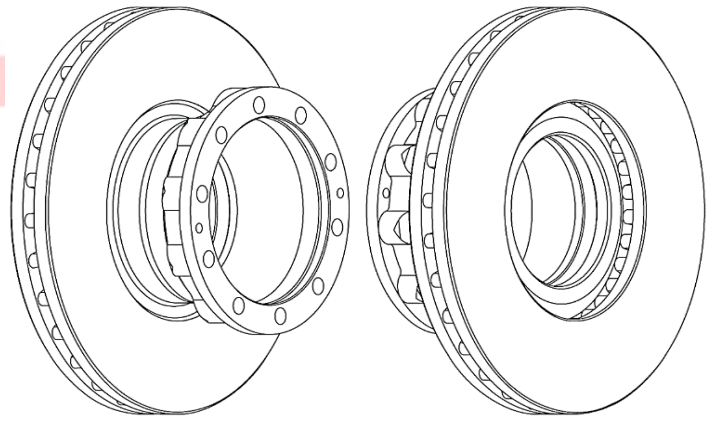


P:disque plein/solid disc
V:disque ventilé/vented disc

Les dessins de disque de frein proviennent/Brake disc drawing come from Federal Mogul



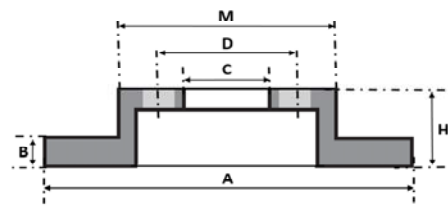
RECHERCHE DISQUES DE FREIN PAR DIMENSIONS BRAKE DISC RESEARCH BY SIZE

A	H	B	B min.	NB Trous/holes	D	C	M	FIXATION	KG	P V				ILLUSTRATIONS / DRAWINGS
335,0	111,0	34,0	28,0	8	177,0	152,0	204,0		14,80	V				
											V MERCEDES ATEGO (7 TONNES) - 09.9182.10 17,5" KNORR SB-SN5 (ABS-) FCR188A 93102400			
335,0	118,0	34,0	26,0	10	176,0	154,0	206,0		17,00	V				
											V MAN TGL - 17,5" KNORR SB-SN5 09.B562.10 (ABS-) FCR272A 93143100			


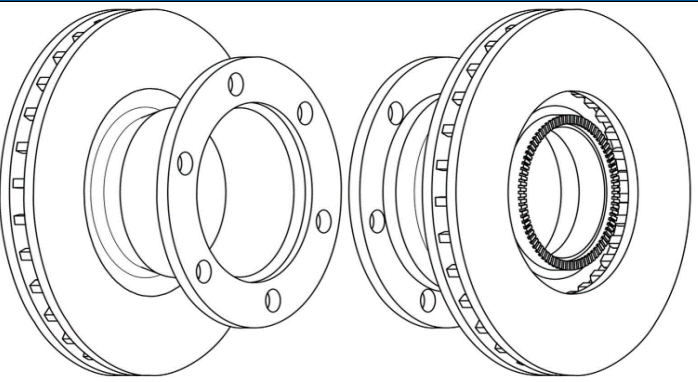


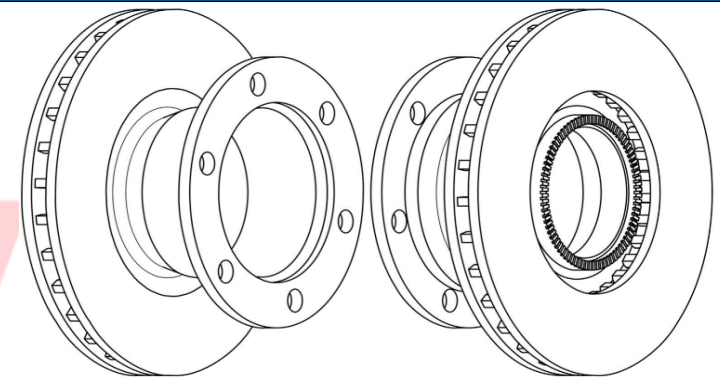
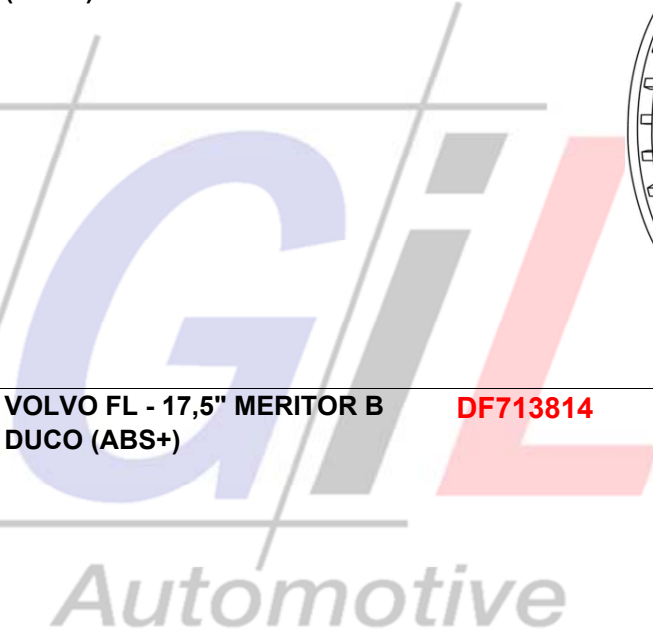
P:disque plein/solid disc
V:disque ventilé/vented disc

Les dessins de disque de frein proviennent/Brake disc drawing come from Federal Mogul



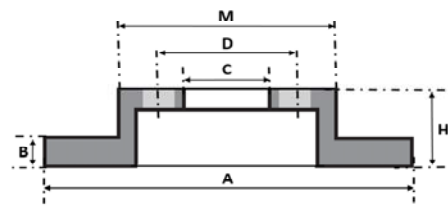
RECHERCHE DISQUES DE FREIN PAR DIMENSIONS BRAKE DISC RESEARCH BY SIZE

A	H	B	B min.	NB Trous/holes	D	C	M	FIXATION	KG	P V	Illustrations / Drawings
335,0	139,0	34,0	31,0	6	205,0	165,0			17,30	V	   V GIGANT - 17,5" KNORR SB-SN5 (ABS+) FCR295A
336,5	139,0	30,0	26,0	8	275,0	139,0			24,80	P	 P VOLVO FL - 17,5" MERITOR B DUCO (ABS+) DF713814



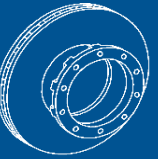
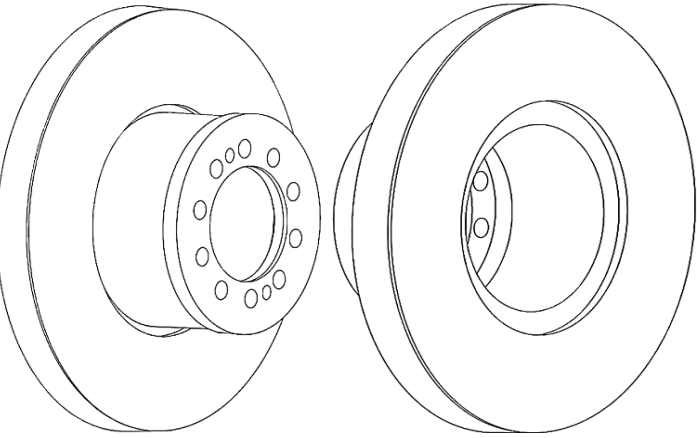
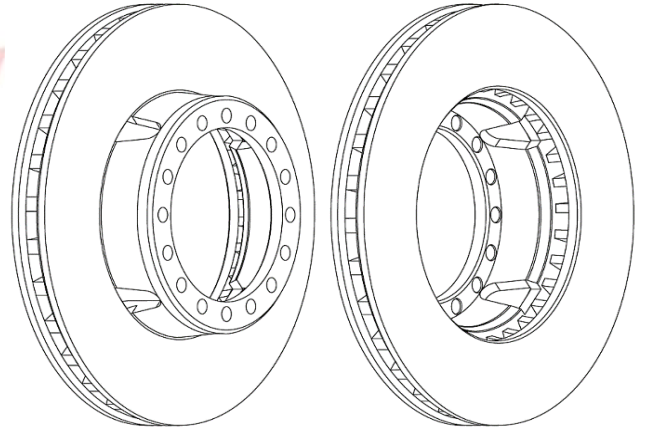


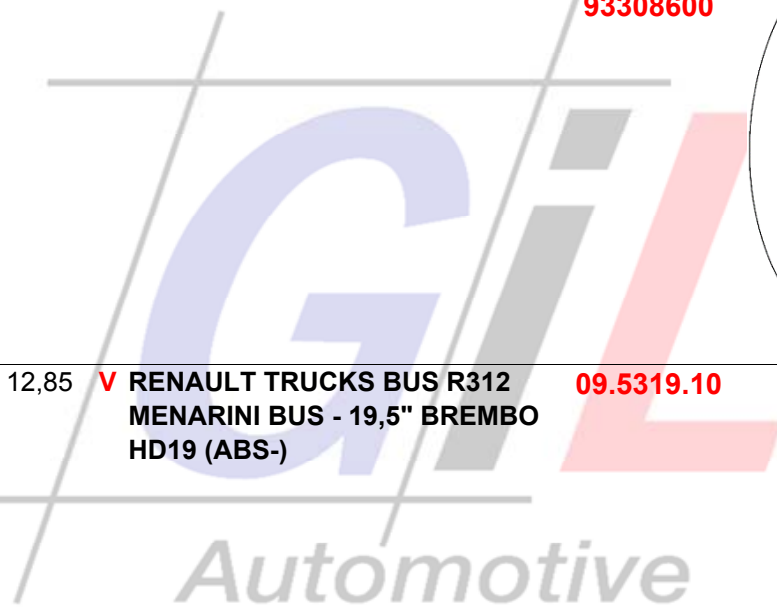
P:disque plein/solid disc
V:disque ventilé/vented disc

Les dessins de disque de frein proviennent/Brake disc drawing come from Federal Mogul



RECHERCHE DISQUES DE FREIN PAR DIMENSIONS BRAKE DISC RESEARCH BY SIZE

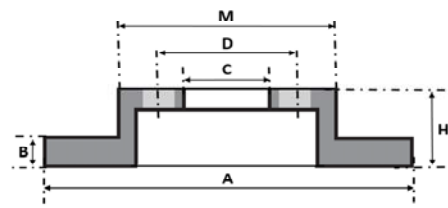
A	H	B	B min.	NB Trous/holes	D	C	M	FIXATION	KG	P V				ILLUSTRATIONS / DRAWINGS
337,0	102,0	30,0	26,0	10	120,0	91,0	127,0	2	18,60	P	VOLVO FL6 FL6 L - 17,5"		08.8240.10 FCR303A 93308600	
350,0	73,0	30,0	27,0	16	165,0	145,0	204,1		12,85	V	RENAULT TRUCKS BUS R312		09.5319.10	
											MENARINI BUS - 19,5" BREMBO			
											HD19 (ABS-)			





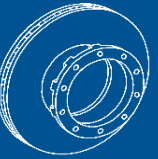
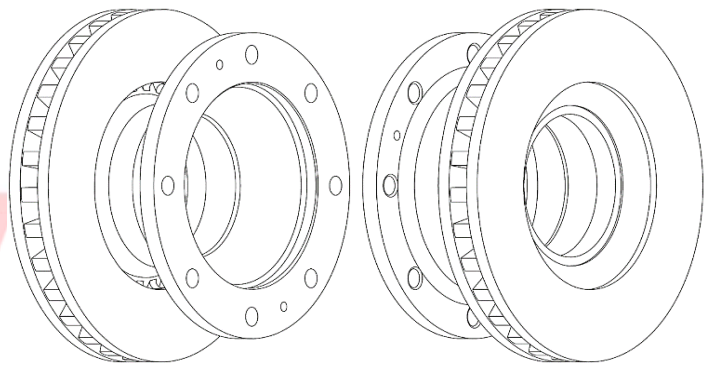
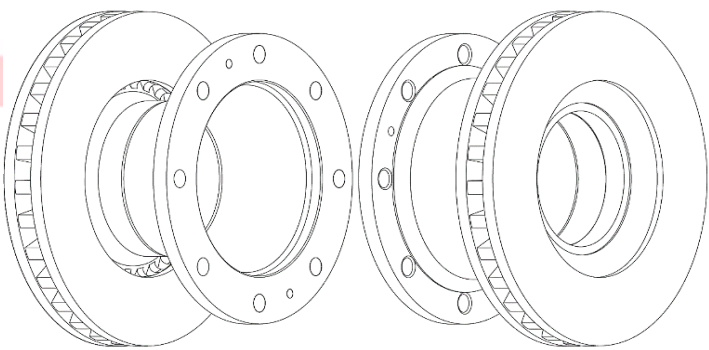
P:disque plein/solid disc

V:disque ventilé/vented disc

Les dessins de disque de frein proviennent/Brake disc drawing come from Federal Mogul



RECHERCHE DISQUES DE FREIN PAR DIMENSIONS BRAKE DISC RESEARCH BY SIZE

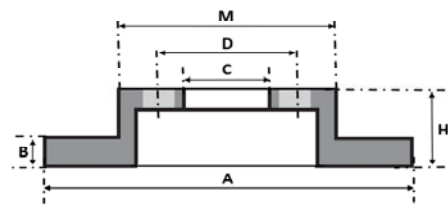
A	H	B	B min.	NB Trous/hole	D	C	M	FIXATION	KG	P V				ILLUSTRATIONS / DRAWINGS
370,0	150,0	45,0	41,0	8	275,0	215,0	321,0	2	32,90	V	IVECO EUROCARGO - 19,5"	BENDIX ADB 3700	09.7315.20 FCR110A 93085000	
370,0	181,5	45,0	41,0	8	275,0	215,0	321,0	2	34,80	V	IVECO EUROCARGO - 19,5"	BENDIX ADB 3700	09.7316.20 FCR111A 93085100	





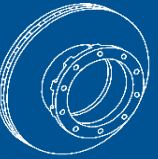
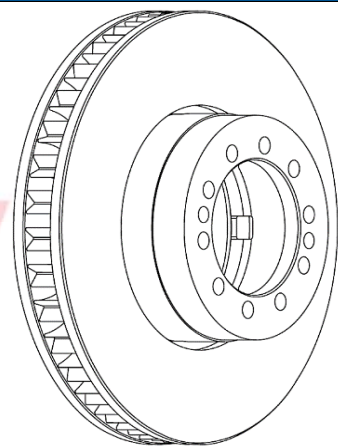
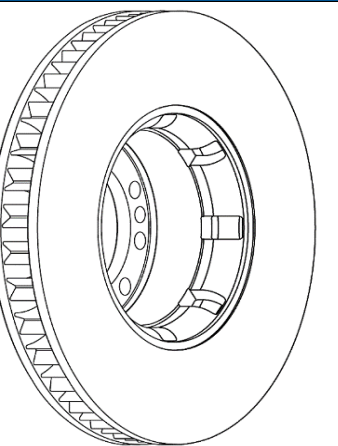
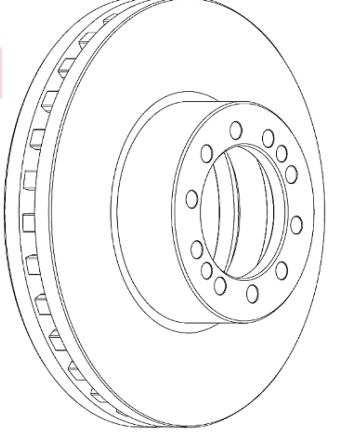
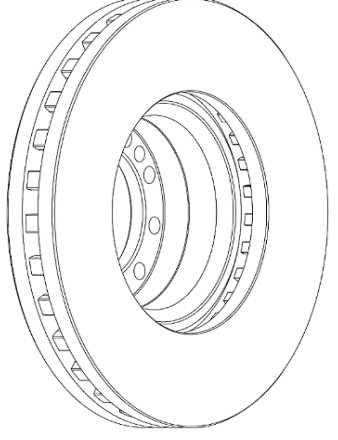
P:disque plein/solid disc

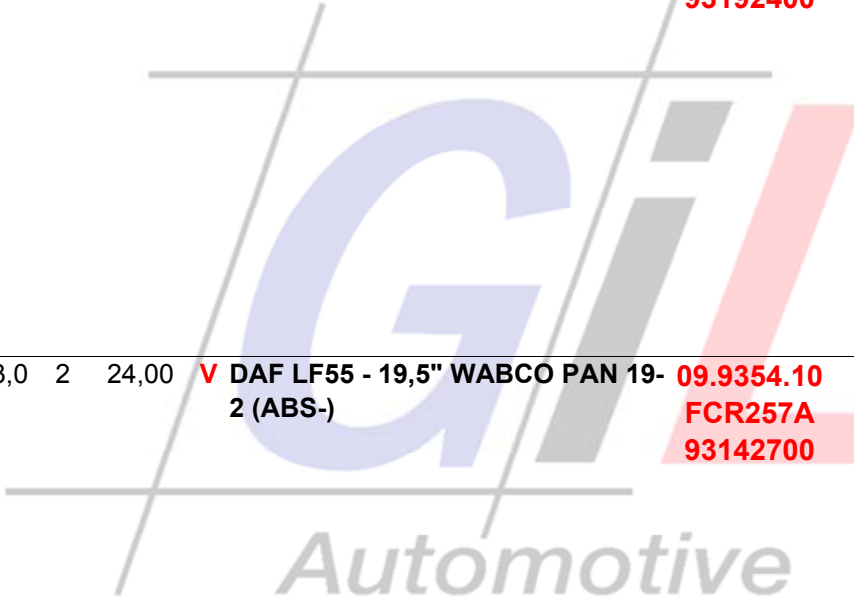
V:disque ventilé/vented disc

Les dessins de disque de frein proviennent/Brake disc drawing come from Federal Mogul



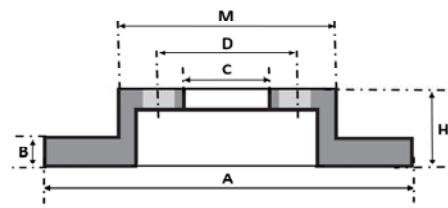
RECHERCHE DISQUES DE FREIN PAR DIMENSIONS BRAKE DISC RESEARCH BY SIZE

A	H	B	B min.	NB Trous/hole	D	C	M	FIXATION	KG	P V				ILLUSTRATIONS / DRAWINGS
375,0	99,0	45,0	37,0	10	144,0	117,0	192,8	2	24,00	V	RENAULT TRUCKS MIDLUM - 19,5" WABCO PAN 19-2 (ABS-)	09.B845.20 FCR242A 93192400		
375,0	99,0	45,0	38,0	10	144,0	117,0	193,0	2	24,00	V	DAF LF55 - 19,5" WABCO PAN 19- 2 (ABS-)	09.9354.10 FCR257A 93142700		



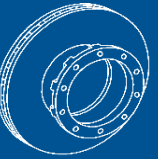
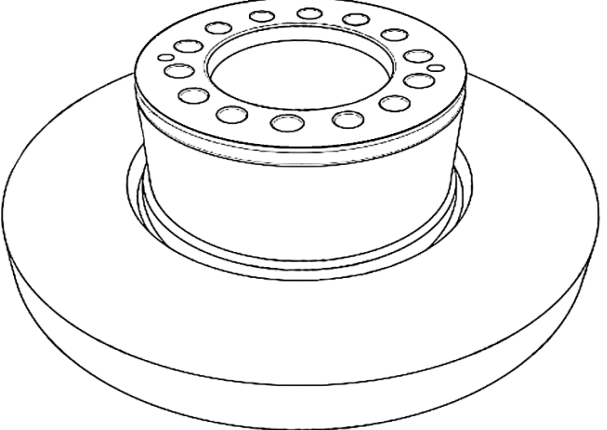
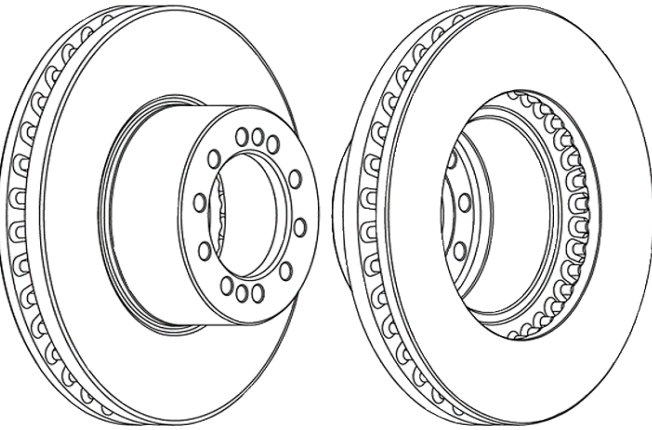


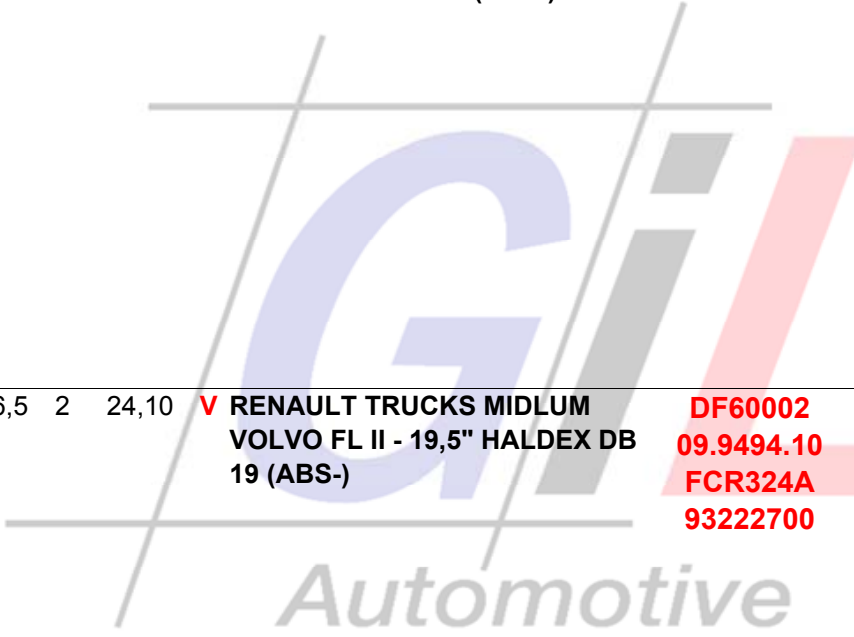
P:disque plein/solid disc
V:disque ventilé/vented disc

Les dessins de disque de frein proviennent/Brake disc drawing come from Federal Mogul



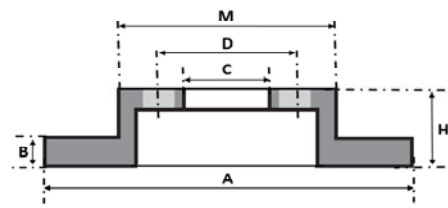
RECHERCHE DISQUES DE FREIN PAR DIMENSIONS BRAKE DISC RESEARCH BY SIZE

A	H	B	B min.	NB Trous/holes	D	C	M	FIXATION	KG	P V				ILLUSTRATIONS / DRAWINGS	
375,0	116,0	45,0	37,0	14	138,0	105,6	2	30,95	P	VOLVO FL6 H EUROPA FL - 19,5"	DF713813	MERITOR C DUCO (ABS-)			
375,0	119,0	45,0	37,0	10	142,0	111,0	196,5	2	24,10	V	RENAULT TRUCKS MIDLUM	DF60002	VOLVO FL II - 19,5" HALDEX DB	09.9494.10	
													FCR324A	93222700	



P:disque plein/solid disc
V:disque ventilé/vented disc

Les dessins de disque de frein proviennent/Brake disc drawing come from Federal Mogul



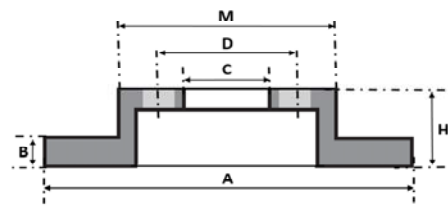
RECHERCHE DISQUES DE FREIN PAR DIMENSIONS BRAKE DISC RESEARCH BY SIZE

A	H	B	B min.	NB Trous/hole	D	C	M	FIXATION	KG	P V		ILLUSTRATIONS / DRAWINGS	
375,0	128,0	44,0	40,0	10	185,0	154,0	220,0		26,80	V	DAF 55 - 19,5" WABCO 1600 V-G	FCR151A 93105700	
375,0	146,0	45,0	38,0	10	209,0	179,0	235,0		24,00	V	DAF LF55 - 19,5" WABCO PAN 19-2 (ABS+ 80 dents/teeth)	09.E452.20 FCR258A 93142800	



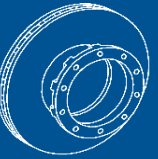
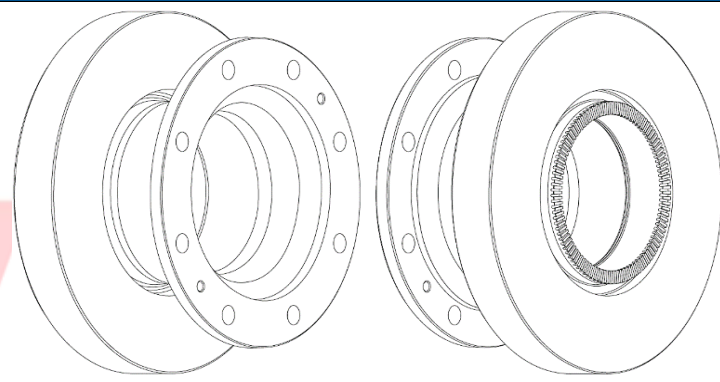
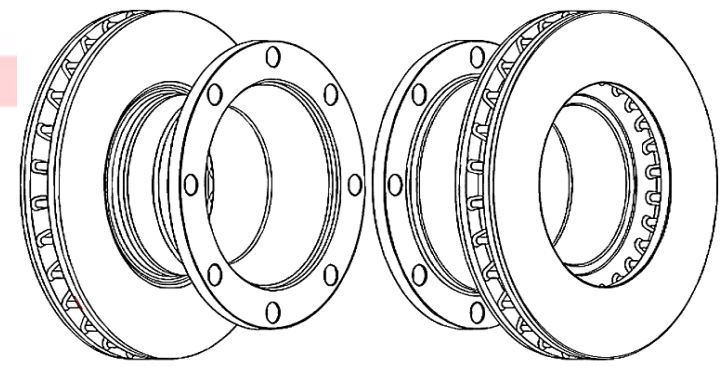


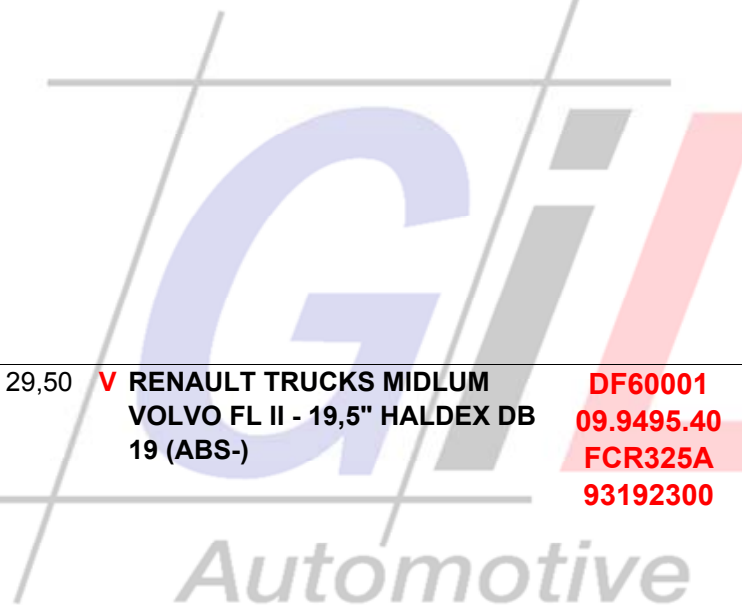
P:disque plein/solid disc
V:disque ventilé/vented disc

Les dessins de disque de frein proviennent/Brake disc drawing come from Federal Mogul



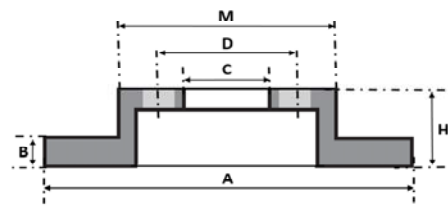
RECHERCHE DISQUES DE FREIN PAR DIMENSIONS BRAKE DISC RESEARCH BY SIZE

A	H	B	B min.	NB Trous/holes	D	C	M	FIXATION	KG	P V				ILLUSTRATIONS / DRAWINGS
375,0	151,0	45,0	38,0	8	275,0	225,0	321,0	2	37,50	P	VOLVO FL6 H EUROPA FL - 19,5"		FCR278A 93243000	
										V	RENAULT TRUCKS MIDLUM VOLVO FL II - 19,5" HALDEX DB 19 (ABS-)		DF60001 09.9495.40 FCR325A 93192300	



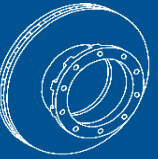
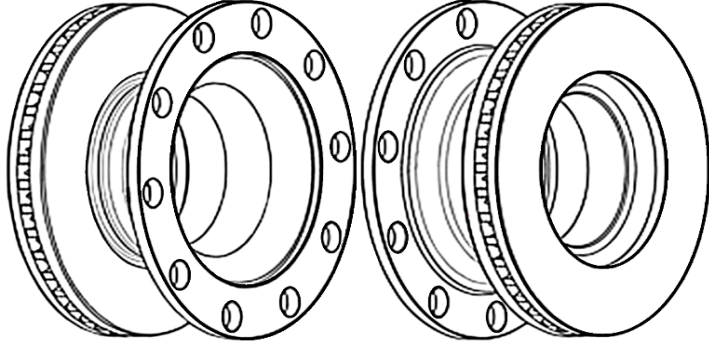
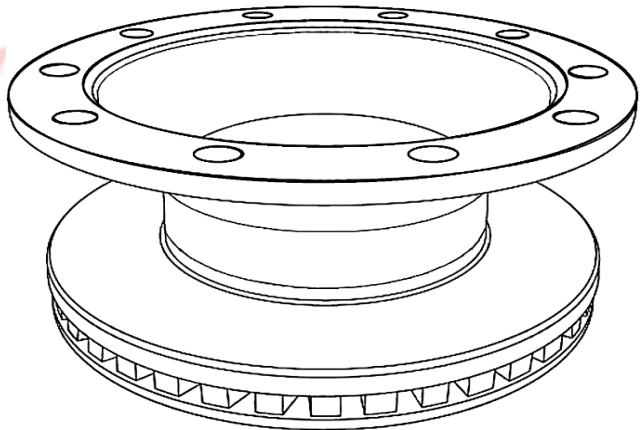


P:disque plein/solid disc
V:disque ventilé/vented disc

Les dessins de disque de frein proviennent/Brake disc drawing come from Federal Mogul



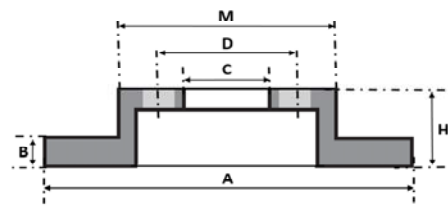
RECHERCHE DISQUES DE FREIN PAR DIMENSIONS BRAKE DISC RESEARCH BY SIZE

A	H	B	B min.	NB Troux/holes	D	C	M	FIXATION	KG	P V				ILLUSTRATIONS / DRAWINGS
375,0	166,5	45,0	37,0	10	335,0	262,0	381,0		32,40	V	RENAULT TRUCKS MIDLUM			
											VOLVO FL II 4X4 - 19,5" HALDEX		09.9496.10	
											DB 19 WABCO PAN 19-2 (ABS-)		FCR378A 93192500	
375,0	168,5	45,0	37,0	10	336,0	290,1	386,0		29,10	V	SCHMITZ - 19,5"			
													09.E403.10 93308800	

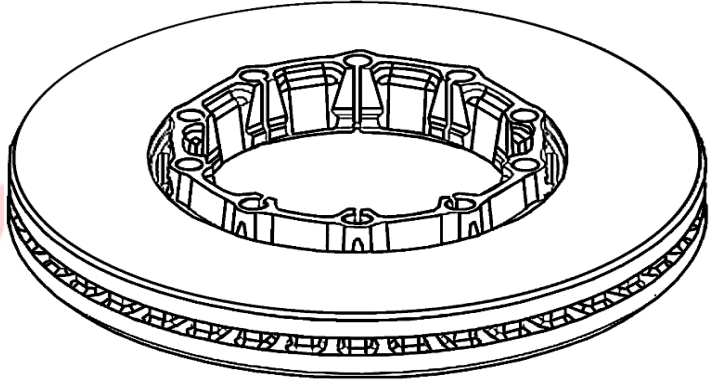
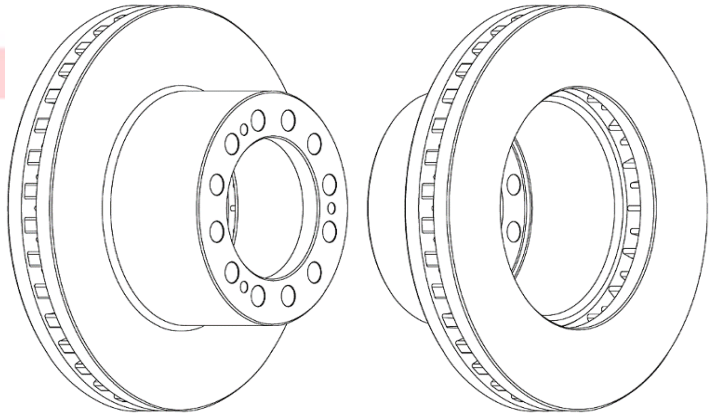


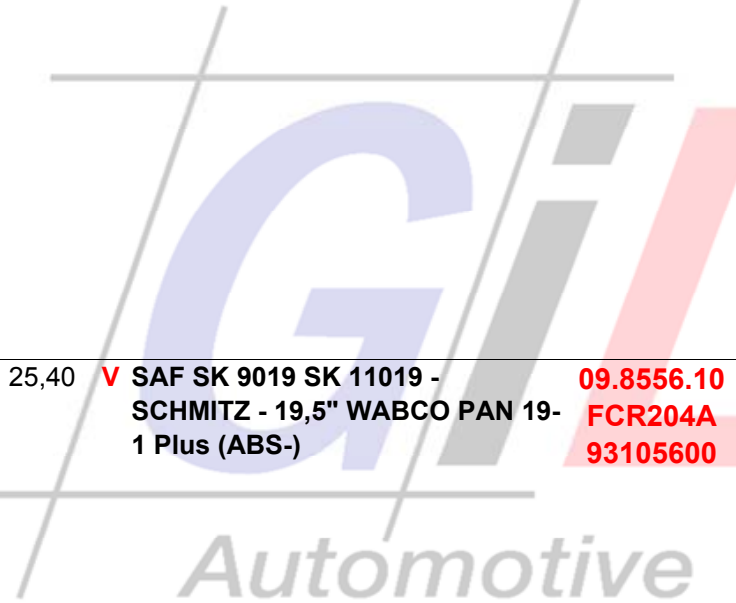
P:disque plein/solid disc
V:disque ventilé/vented disc

Les dessins de disque de frein proviennent/Brake disc drawing come from Federal Mogul



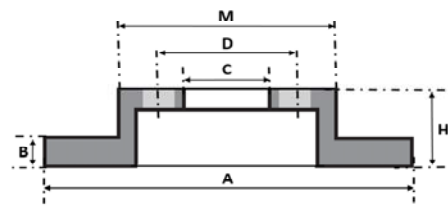
RECHERCHE DISQUES DE FREIN PAR DIMENSIONS BRAKE DISC RESEARCH BY SIZE

A	H	B	B min.	NB Trous/holes	D	C	M	FIXATION	KG	P V		ILLUSTRATIONS / DRAWINGS
376,0	57,5	45,0	37,0	10	190,0	164,0	202,0		23,00	V	SAF SKRB 9019 - 19,5" KNORR SB-SN6 AXIAL	09.E156.10 93193400 
376,0	139,4	45,0	37,0	12	168,0	131,0	217,9	3	25,40	V	SAF SK 9019 SK 11019 - SCHMITZ - 19,5" WABCO PAN 19- 1 Plus (ABS-)	09.8556.10 FCR204A 93105600 



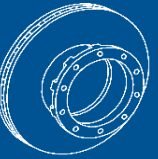
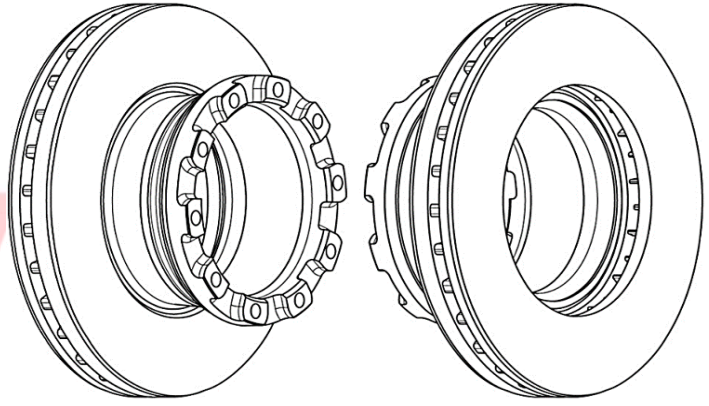
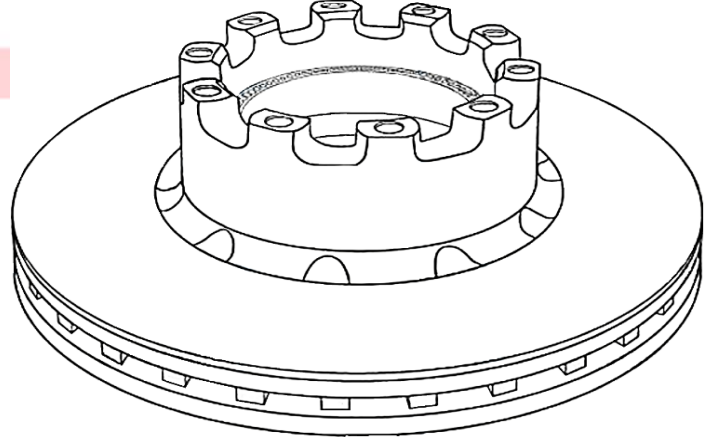


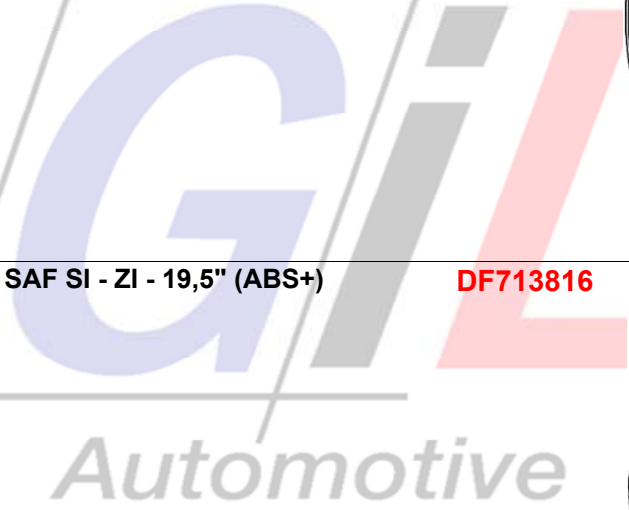
P:disque plein/solid disc
V:disque ventilé/vented disc

Les dessins de disque de frein proviennent/Brake disc drawing come from Federal Mogul



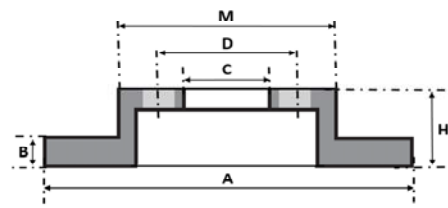
RECHERCHE DISQUES DE FREIN PAR DIMENSIONS BRAKE DISC RESEARCH BY SIZE

A	H	B	B min.	NB Trous/hole	D	C	M	FIXATION	KG	P V				ILLUSTRATIONS / DRAWINGS
376,0	141,0	45,0	37,0	10	215,0	189,1	240,0		27,80	V	SAF - 19,5" KNORR SN6		FCR373A 09.E163.10	
376,0	145,0	45,0	37,0	10	193,0	164,0			28,00	V	SAF SI - ZI - 19,5" (ABS+)		DF713816	



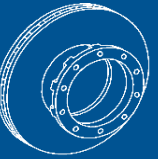


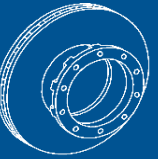
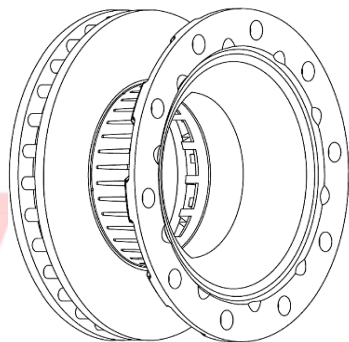
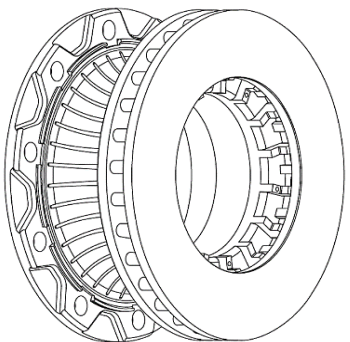


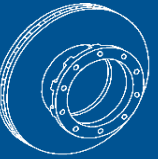
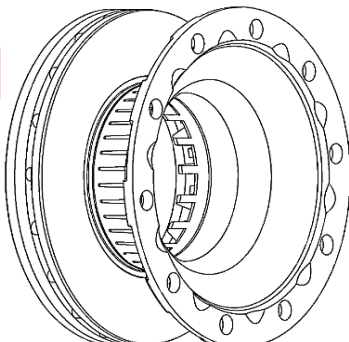
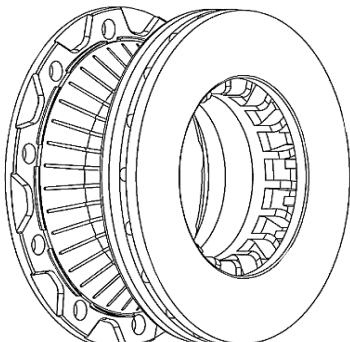


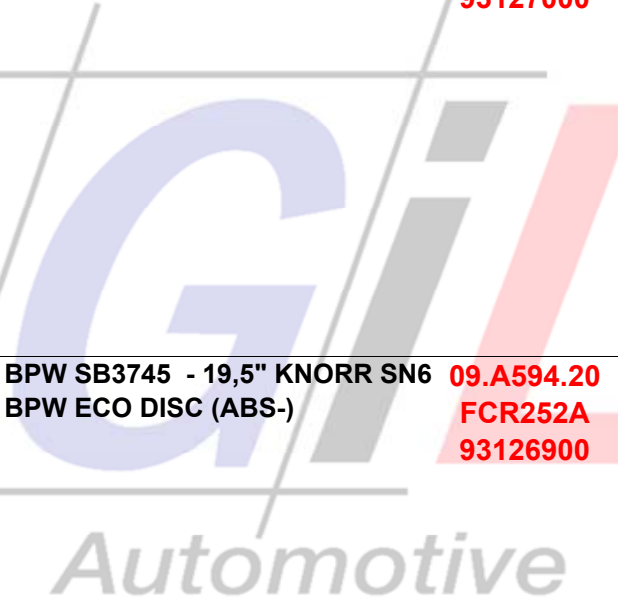
P:disque plein/solid disc
V:disque ventilé/vented disc

Les dessins de disque de frein proviennent/Brake disc drawing come from Federal Mogul



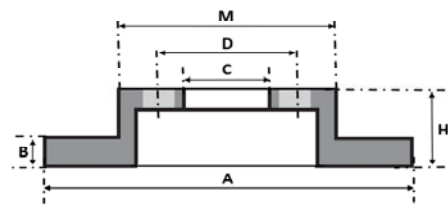
RECHERCHE DISQUES DE FREIN PAR DIMENSIONS BRAKE DISC RESEARCH BY SIZE

A	H	B	B min.	NB Trous/holes	D	C	M	FIXATION	KG	P V				ILLUSTRATIONS / DRAWINGS
376,0	159,0	45,0	40,0	10	335,0	299,0	380,0		29,00	V				 
											BPW SB3745 - 19,5" KNORR SN6 09.A594.20 BPW ECO DISC (ABS+) FCR253A 93127000			
376,0	159,5	45,0	40,0	10	335,0	299,0	380,0		28,70	V				 
											BPW SB3745 - 19,5" KNORR SN6 09.A594.20 BPW ECO DISC (ABS-) FCR252A 93126900			



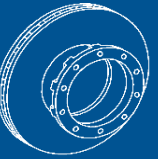
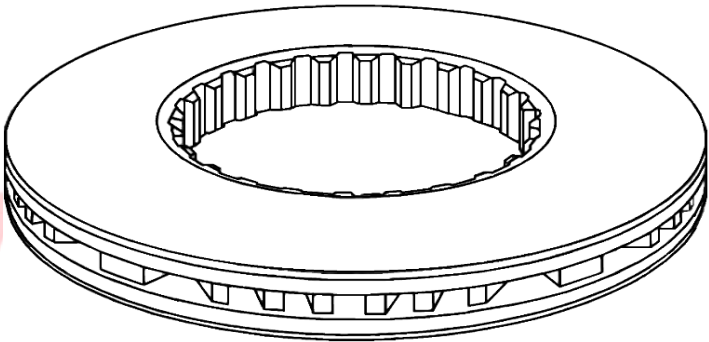
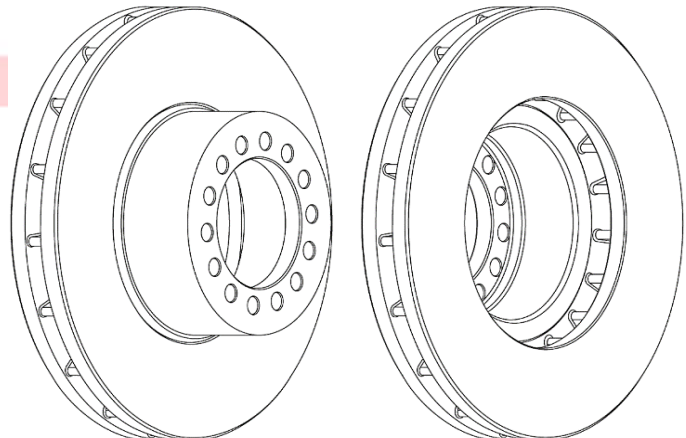


P:disque plein/solid disc
V:disque ventilé/vented disc

Les dessins de disque de frein proviennent/Brake disc drawing come from Federal Mogul



RECHERCHE DISQUES DE FREIN PAR DIMENSIONS BRAKE DISC RESEARCH BY SIZE

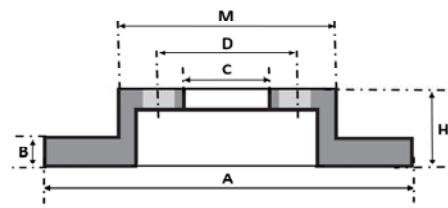
A	H	B	B min.	NB Troux/holes	D	C	M	FIXATION	KG	P V				ILLUSTRATIONS / DRAWINGS
377,0	45,0	45,0	41,0		199,0				20,00	V	RENAULT TRUCKS MAGNUM DXI		DF70011	
											PREMIUM VOLVO FH FM - 19,5"		09.E451.10	
											MERITOR VGT 195 (ABS-)		FCR328A 93322800	
377,0	107,0	45,0	37,0	14	144,0	113,0	194,0		24,90	V	IVECO EUROCARGO TECTOR		09.A562.10	
											130 150 - 19,5" KNORR SB-SN6 (ABS-)		FCR319A 93175200	





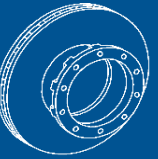
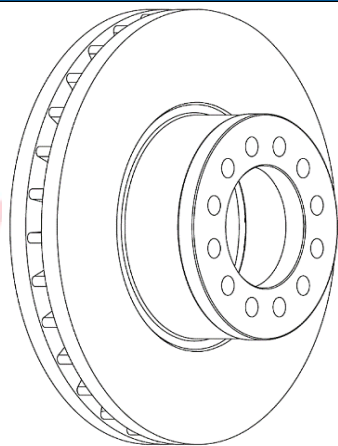
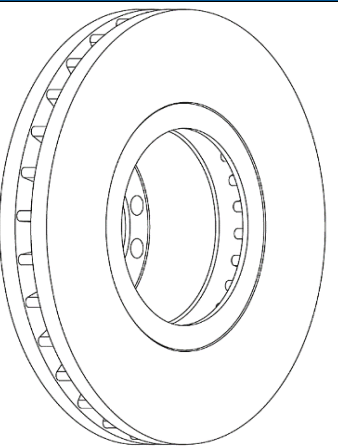
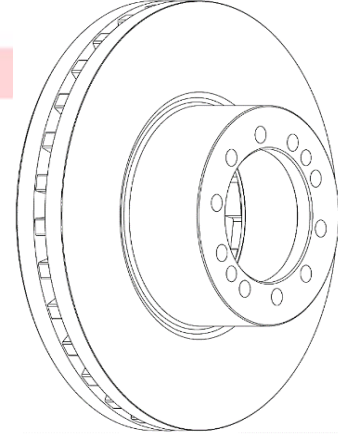
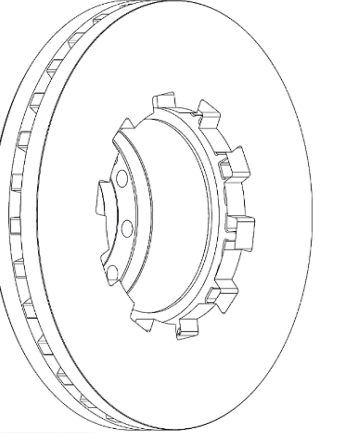
P:disque plein/solid disc

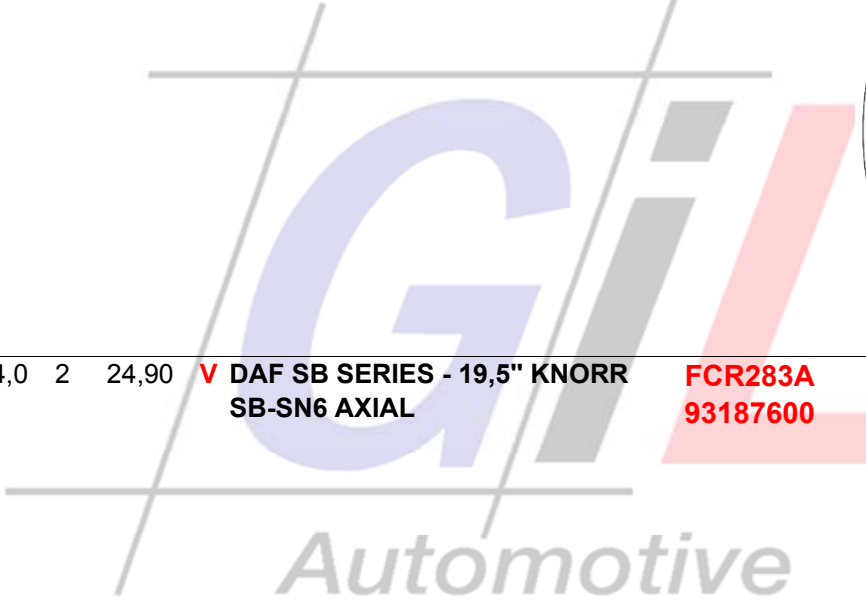
V:disque ventilé/vented disc

Les dessins de disque de frein proviennent/Brake disc drawing come from Federal Mogul



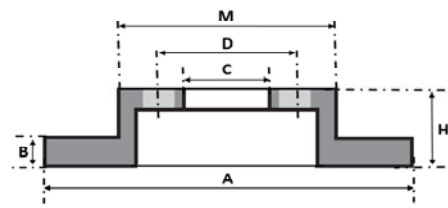
RECHERCHE DISQUES DE FREIN PAR DIMENSIONS BRAKE DISC RESEARCH BY SIZE

A	H	B	B min.	NB Trous/holes	D	C	M	FIXATION	KG	P V				ILLUSTRATIONS / DRAWINGS
377,0	108,0	45,0	37,0	12	144,0	106,0	196,0		19,00	V	MAN TGM - 19,5" KNORR SB-SN6 (ABS-)	FCR331A 93191200		
377,0	112,0	45,0	38,0	10	144,0	117,0	194,0	2	24,90	V	DAF SB SERIES - 19,5" KNORR SB-SN6 AXIAL	FCR283A 93187600		



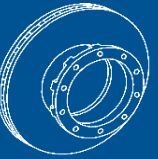
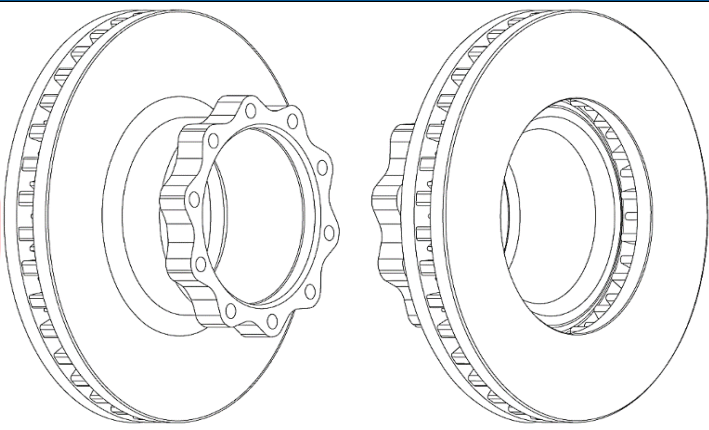
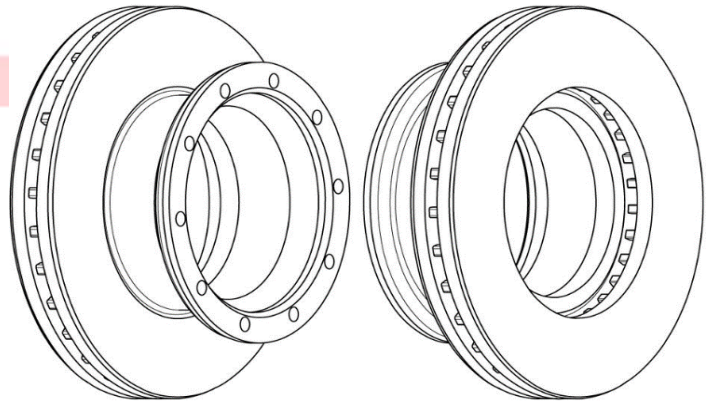


P:disque plein/solid disc
V:disque ventilé/vented disc

Les dessins de disque de frein proviennent/Brake disc drawing come from Federal Mogul



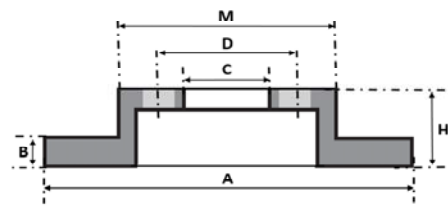
RECHERCHE DISQUES DE FREIN PAR DIMENSIONS BRAKE DISC RESEARCH BY SIZE

A	H	B	B min.	NB Trous/holes	D	C	M	FIXATION	KG	P V				ILLUSTRATIONS / DRAWINGS
377,0	128,0	45,0	38,0	10	195,0	162,0	223,0		22,70	V	MAN M2000 SERIES TGM - 19,5"	KNORR SB-SN6 (ABS-)	09.A461.10 FCR147A 93086900	
377,0	131,5	45,0	37,0	10	238,0	211,0	270,0		27,30	V	MERCEDES TE - 19,5"	KNORR SB-SN6	FCR346A 93276800	



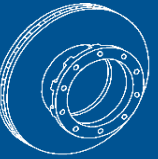


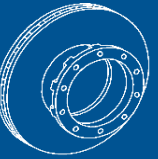
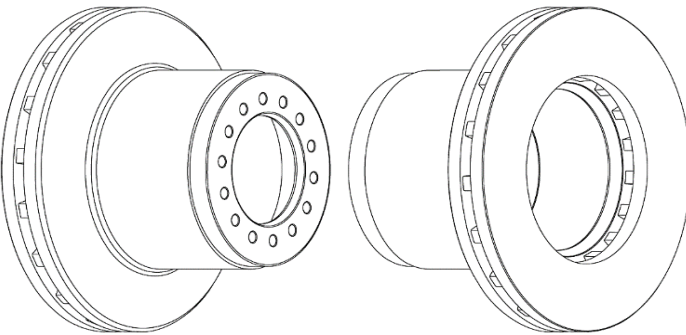


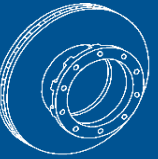
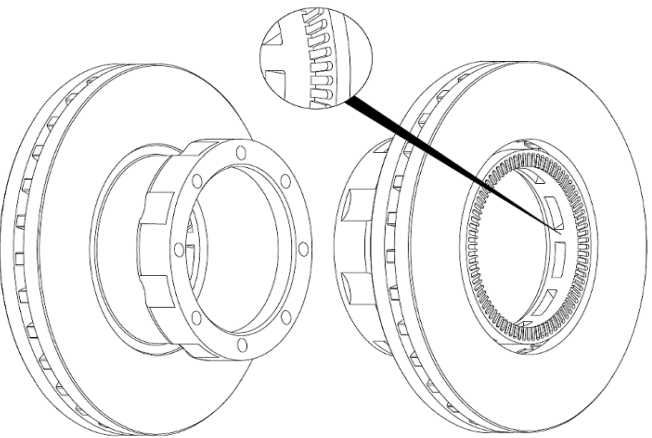


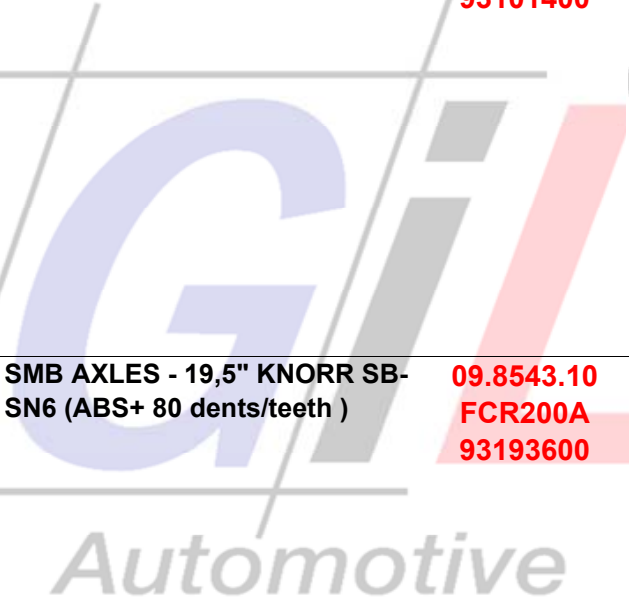
P:disque plein/solid disc
V:disque ventilé/vented disc

Les dessins de disque de frein proviennent/Brake disc drawing come from Federal Mogul



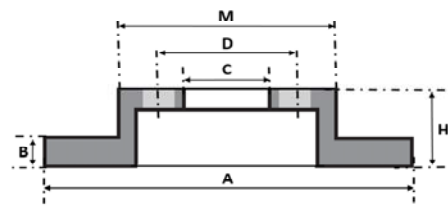
RECHERCHE DISQUES DE FREIN PAR DIMENSIONS BRAKE DISC RESEARCH BY SIZE

A	H	B	B min.	NB Trous/holes	D	C	M	FIXATION	KG	P V				ILLUSTRATIONS / DRAWINGS
377,0	134,0	45,0	37,0	14	138,0	105,5	188,0		23,90	V				
											MERCEDES ATEGO TOURINO - 19,5" KNORR SB-SN6 (ABS-)		09.8573.10 FCR189A 93101400	
377,0	138,5	45,0	37,0	8	196,0	169,0	226,0		28,00	V				
											SMB AXLES - 19,5" KNORR SB-SN6 (ABS+ 80 dents/teeth)		09.8543.10 FCR200A 93193600	



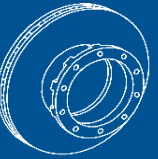
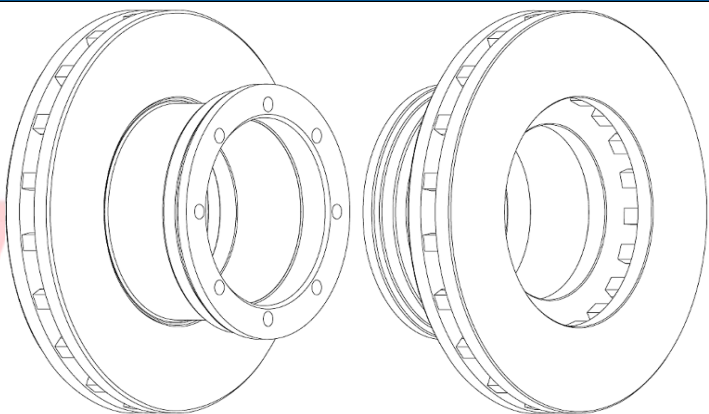
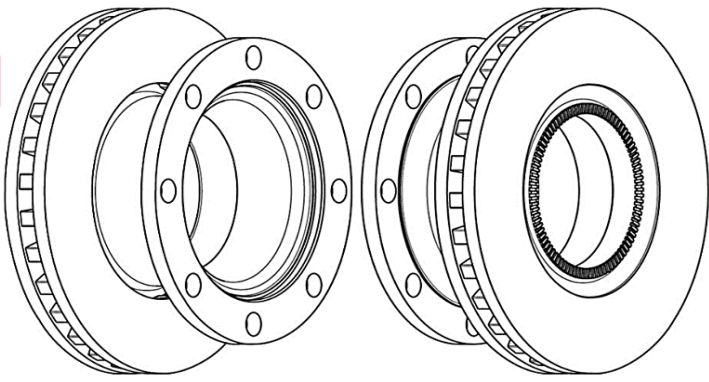


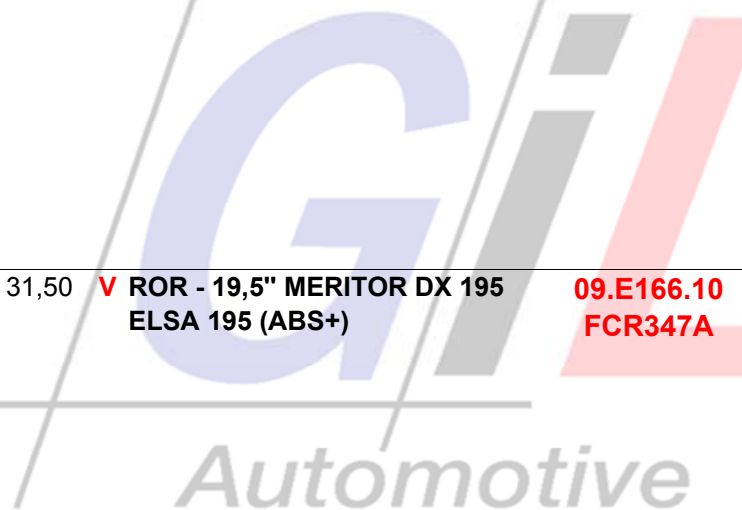
P:disque plein/solid disc
V:disque ventilé/vented disc

Les dessins de disque de frein proviennent/Brake disc drawing come from Federal Mogul



RECHERCHE DISQUES DE FREIN PAR DIMENSIONS BRAKE DISC RESEARCH BY SIZE

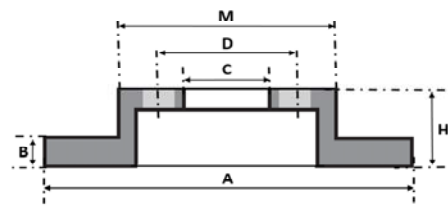
A	H	B	B min.	NB Trous/hole	D	C	M	FIXATION	KG	P V				ILLUSTRATIONS / DRAWINGS
377,0	138,5	45,0	37,0	8	201,0	176,0	228,0		26,00	V	MERCEDES ATEGO TOURINO	DISCOS - 19,5" KNORR SB-SN6	(ABS-)	09.8925.10 FCR190A 93101500 
377,0	150,0	45,0	37,0	8	270,0	225,0			31,50	V	ROR - 19,5" MERITOR DX 195	ELSA 195 (ABS+)	09.E166.10 FCR347A 	





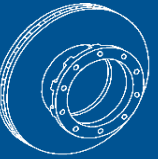


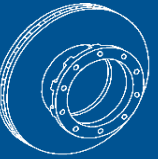
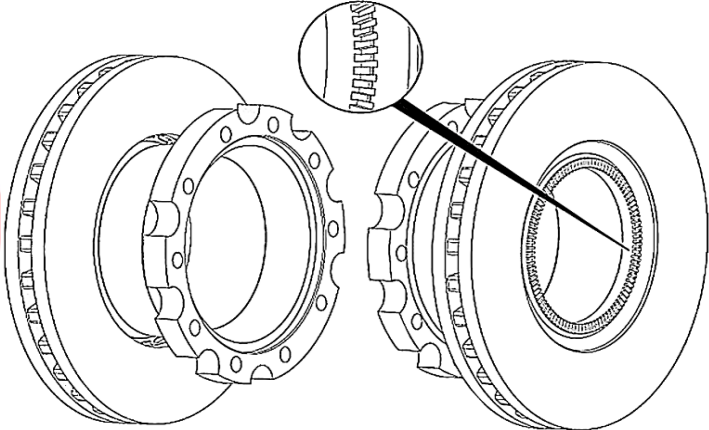


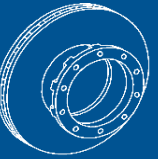
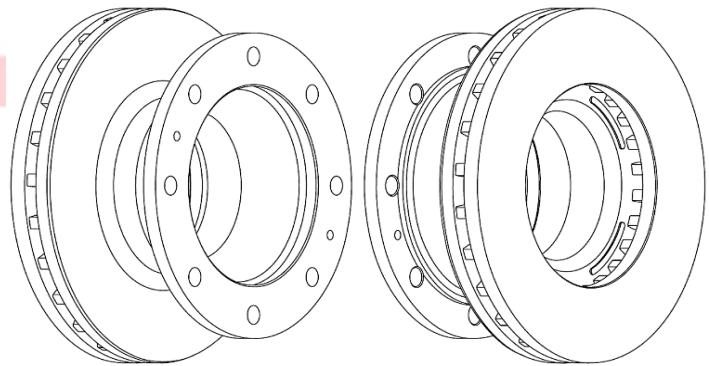
P:disque plein/solid disc

V:disque ventilé/vented disc

Les dessins de disque de frein proviennent/Brake disc drawing come from Federal Mogul



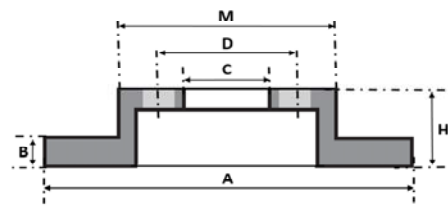
RECHERCHE DISQUES DE FREIN PAR DIMENSIONS BRAKE DISC RESEARCH BY SIZE

A	H	B	B min.	NB Trous/holes	D	C	M	FIXATION	KG	P V				ILLUSTRATIONS / DRAWINGS
377,0	150,0	45,0	37,0	10	250,0	222,0	286,0		30,40	V				
											V ROR LC, LM, TM - 19,5" MERITOR DX 195 ELSA 195 (ABS+)		09.8979.10 FCR223A 93117700	
377,0	151,0	45,0	37,0	8	275,0	215,0	325,0	2	30,60	V				
											V IVECO EUROCARGO TECTOR 130 - 19,5" KNORR SB-SN6		09.A563.40 FCR238A 93127500	



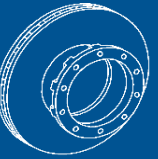
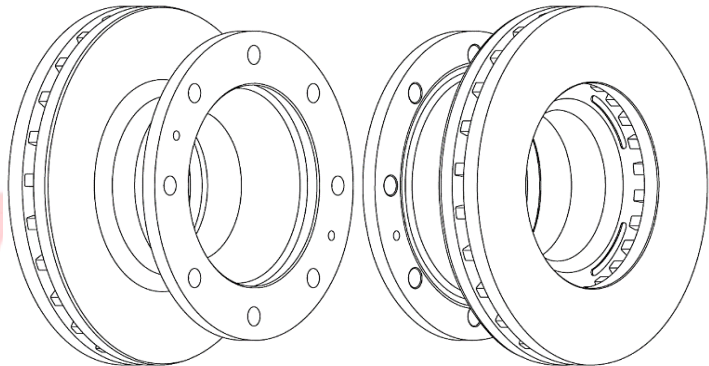
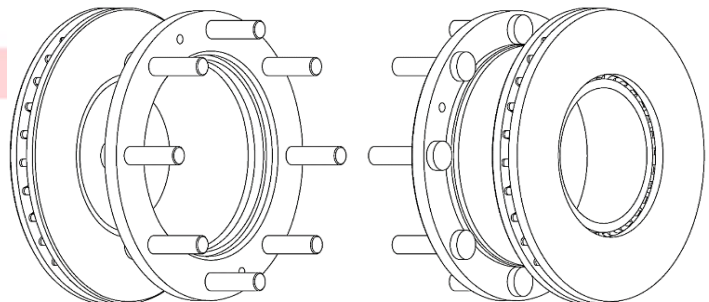


P:disque plein/solid disc
V:disque ventilé/vented disc

Les dessins de disque de frein proviennent/Brake disc drawing come from Federal Mogul



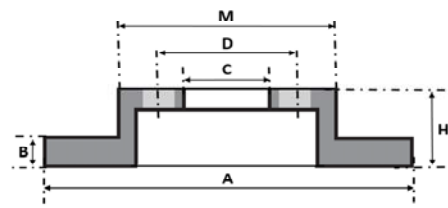
RECHERCHE DISQUES DE FREIN PAR DIMENSIONS BRAKE DISC RESEARCH BY SIZE

A	H	B	B min.	NB Trous/holes	D	C	M	FIXATION	KG	P V				ILLUSTRATIONS / DRAWINGS
377,0	151,0	45,0	37,0	8	275,0	215,0	325,0	2	30,30	V	IVECO EUROCARGO TECTOR	140 150 - 19,5" KNORR SB-SN6	(ABS-)	09.A563.30 FCR239A 93127600 
377,0	151,0	45,0	37,0	10	275,0	225,0	325,0	2	33,60	V	IVECO EUROCARGO TECTOR	130 - 19,5" KNORR SB-SN6	(ABS+)	09.7929.90 09.A563.90 FCR307A 93188600 



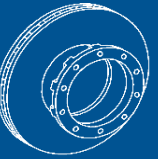


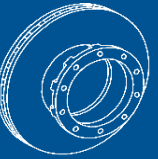
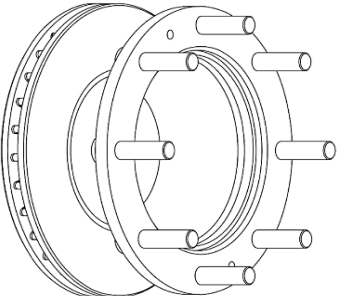
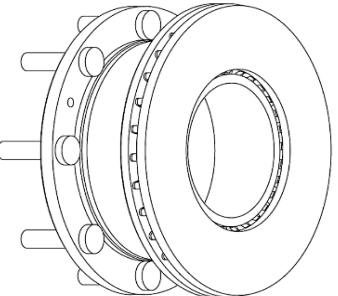


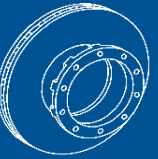
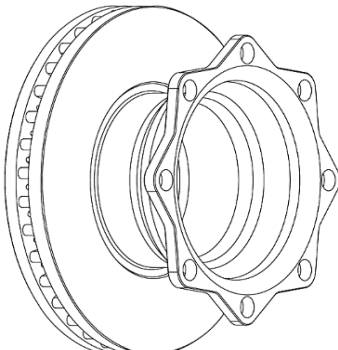
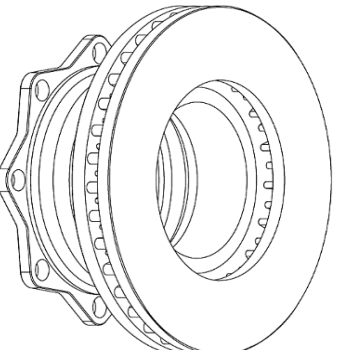


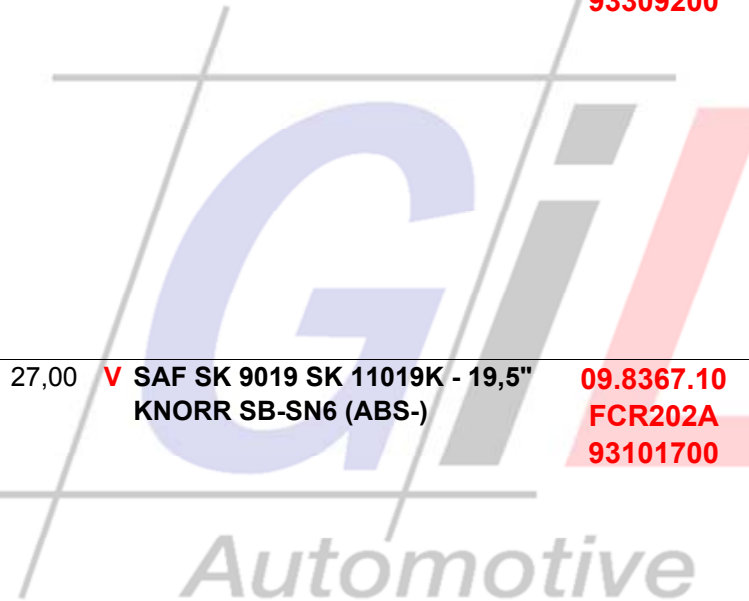
P:disque plein/solid disc
V:disque ventilé/vented disc

Les dessins de disque de frein proviennent/Brake disc drawing come from Federal Mogul



RECHERCHE DISQUES DE FREIN PAR DIMENSIONS BRAKE DISC RESEARCH BY SIZE

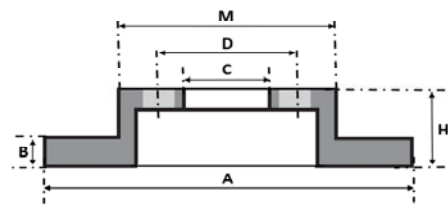
A	H	B	B min.	NB Trous/holes	D	C	M	FIXATION	KG	P V				ILLUSTRATIONS / DRAWINGS
377,0	151,3	45,0	37,0	8	275,0	225,0	325,0	2	32,00	V				 
											IVECO TECTOR 150 - 19,5" KNORR SB-SN6 (ABS+)		09.A563.80 FCR308A 93309200	
377,0	157,5	45,0	37,0	8	275,0	169,0	314,5		27,00	V				 
											SAF SK 9019 SK 11019K - 19,5" KNORR SB-SN6 (ABS-)		09.8367.10 FCR202A 93101700	





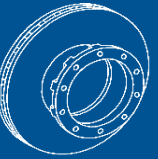
P:disque plein/solid disc

V:disque ventilé/vented disc

Les dessins de disque de frein proviennent/Brake disc drawing come from Federal Mogul



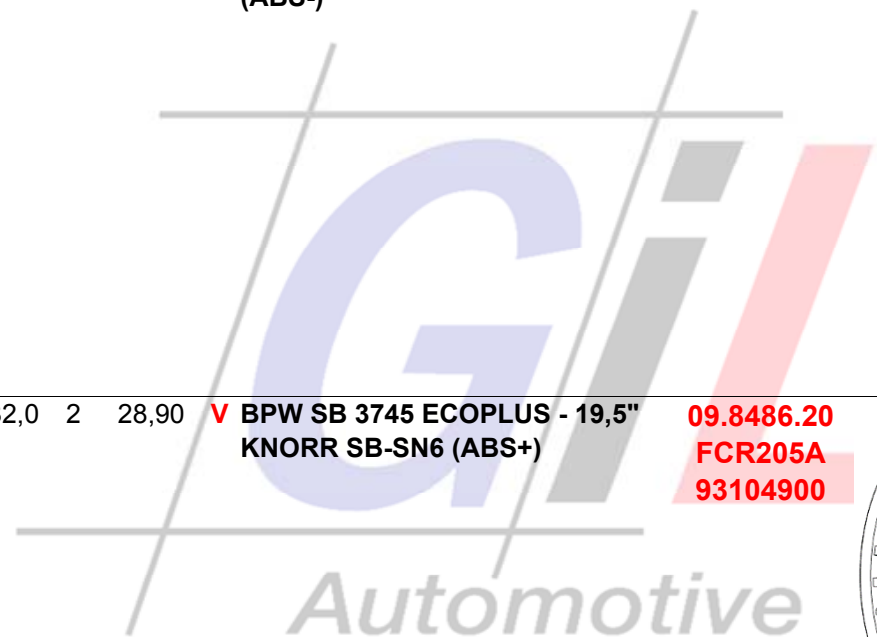
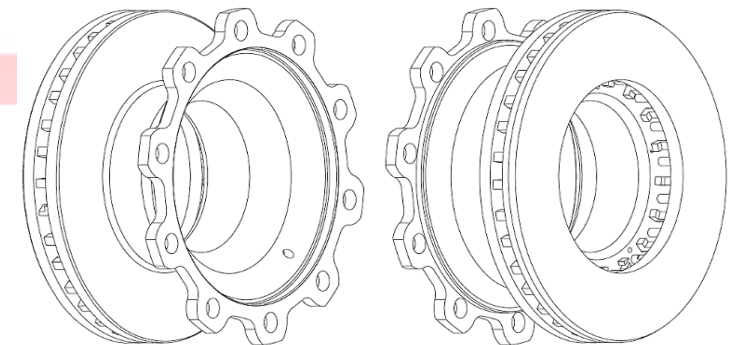
RECHERCHE DISQUES DE FREIN PAR DIMENSIONS BRAKE DISC RESEARCH BY SIZE

A	H	B	B min.	NB Trous/holes	D	C	M	FIXATION	KG	P V				ILLUSTRATIONS / DRAWINGS
---	---	---	--------	----------------	---	---	---	----------	----	--------	--	---	---	--------------------------

377,0	157,5	45,0	37,0	8	275,0		319,0		28,50	V	SAF NEW - 19,5"	KNORR SB-SN6	DF713875	
											(ABS-)			

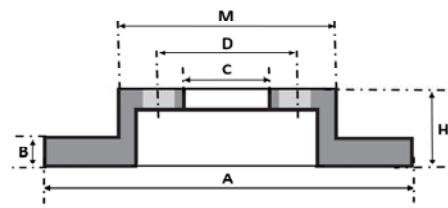


377,0	159,5	45,0	37,0	10	335,0	290,0	382,0	2	28,90	V	BPW SB 3745 ECOPLUS - 19,5"	KNORR SB-SN6 (ABS+)	09.8486.20 FCR205A 93104900	
-------	-------	------	------	----	-------	-------	-------	---	-------	---	-----------------------------	---------------------	-----------------------------------	--



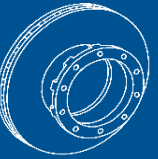
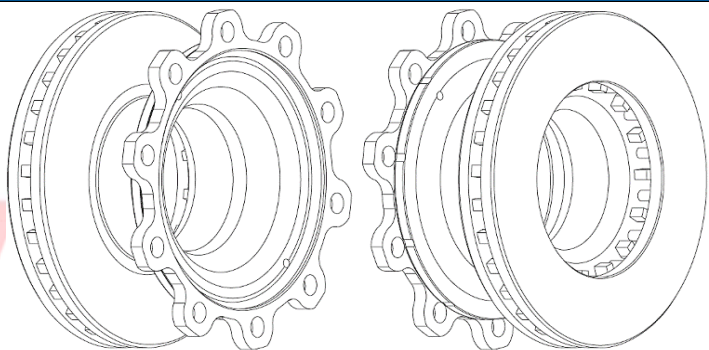
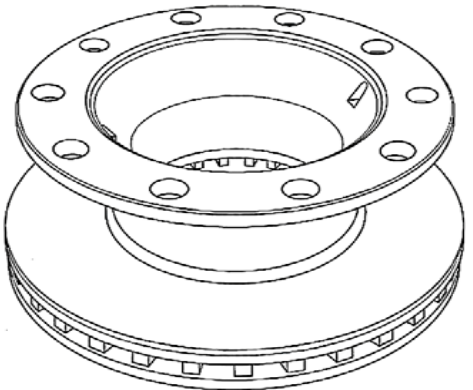


P:disque plein/solid disc
V:disque ventilé/vented disc

Les dessins de disque de frein proviennent/Brake disc drawing come from Federal Mogul



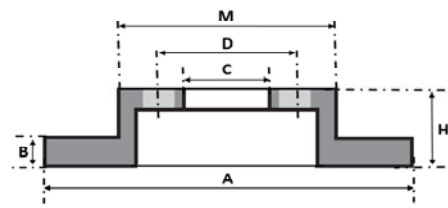
RECHERCHE DISQUES DE FREIN PAR DIMENSIONS BRAKE DISC RESEARCH BY SIZE

A	H	B	B min.	NB Trous/hole	D	C	M	FIXATION	KG	P V				ILLUSTRATIONS / DRAWINGS
377,0	159,5	45,0	37,0	10	335,0	290,0	382,0	2	28,90	V	BPW SB 3745 ECOPLUS - 19,5"	KNORR SB-SN6 (ABS-)	09.8486.20 FCR193A 93095800	
377,0	165,5	45,0	40,0	10	286,0	222,0	330,0		27,50	V	BPW SKH ECO MAXX ECO PLUS - 19,5"	KNORR SB-SN6 (ABS-)	FCR280A	



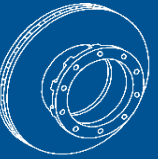
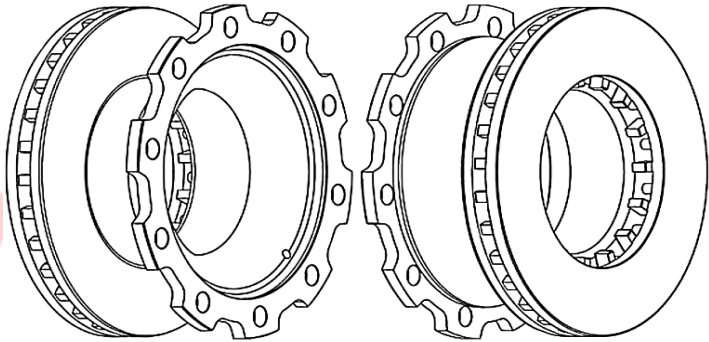
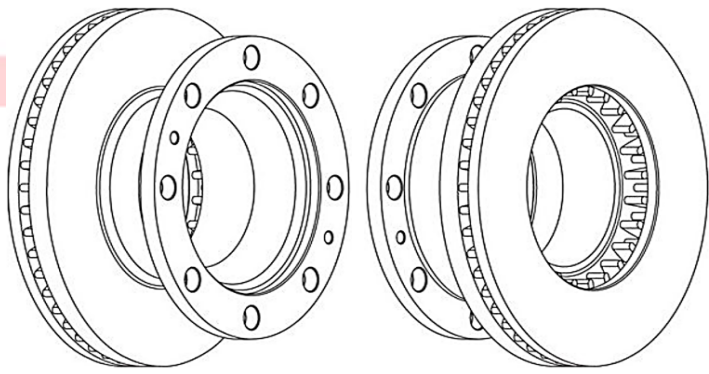


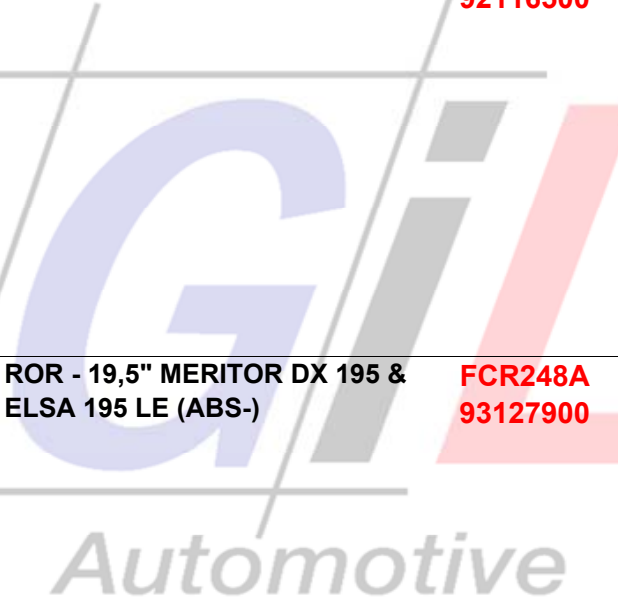
P:disque plein/solid disc
V:disque ventilé/vented disc

Les dessins de disque de frein proviennent/Brake disc drawing come from Federal Mogul



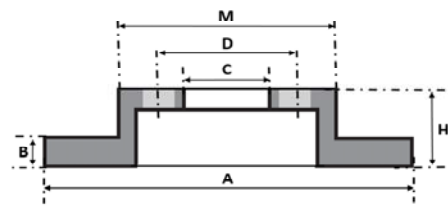
RECHERCHE DISQUES DE FREIN PAR DIMENSIONS BRAKE DISC RESEARCH BY SIZE

A	H	B	B min.	NB Trous/hole	D	C	M	FIXATION	KG	P V				ILLUSTRATIONS / DRAWINGS
377,0	169,5	45,0	40,0	10	335,0	290,0	383,0		29,30	V	BPW SB3745 ECO PLUS - 19,5"		09.9900.10 FCR210A 92116500	
											KNORR SB-SN6 AXIAL			
378,0	150,0	45,0	39,0	8	275,0	225,0	319,0	2	32,50	V	ROR - 19,5" MERITOR DX 195 & ELSA 195 LE (ABS-)		FCR248A 93127900	



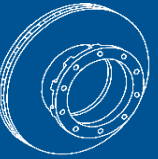
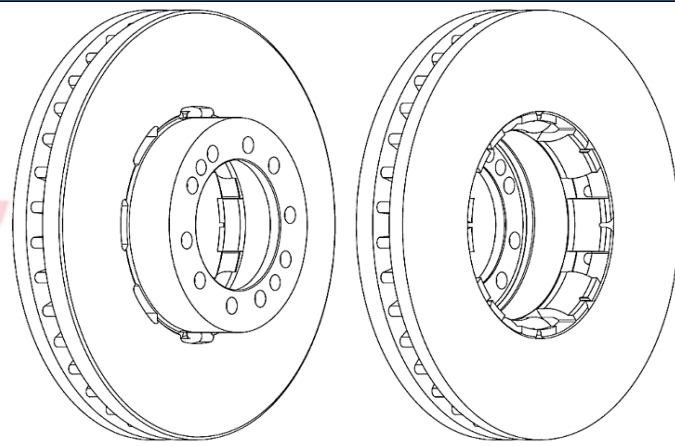
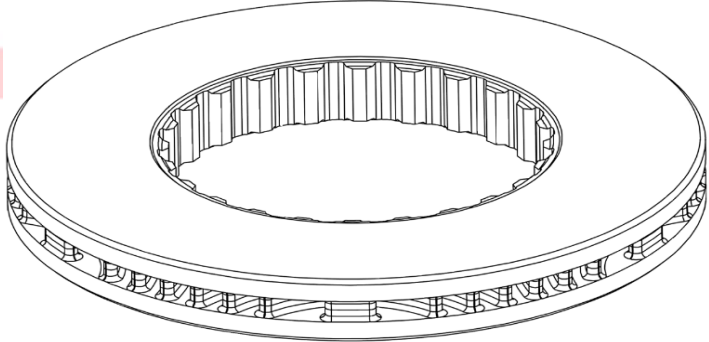


P:disque plein/solid disc
V:disque ventilé/vented disc

Les dessins de disque de frein proviennent/Brake disc drawing come from Federal Mogul



RECHERCHE DISQUES DE FREIN PAR DIMENSIONS BRAKE DISC RESEARCH BY SIZE

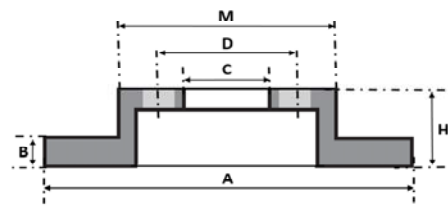
A	H	B	B min.	NB Trous/holes	D	C	M	FIXATION	KG	P V				ILLUSTRATIONS / DRAWINGS
380,0	85,0	45,0	40,0	10	144,0	117,0	190,0	2	24,00	V	RENAULT TRUCKS MIDLUM - 19,5" WABCO PAN 19-2 (ABS-)	FCR185A 93192000		
410,0	45,0	45,0	41,0		220,0	220,0			23,00	V	RENAULT TRUCKS MAGNUM DXI PREMIUM VOLVO FH FM - 22,5" MERITOR ELSA 225-3 (ABS-)	DF70009 FCR348A 93322700		





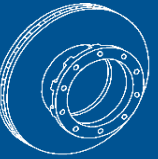
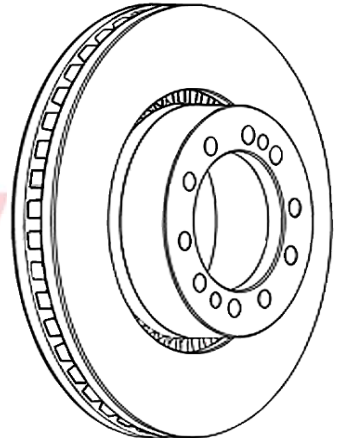
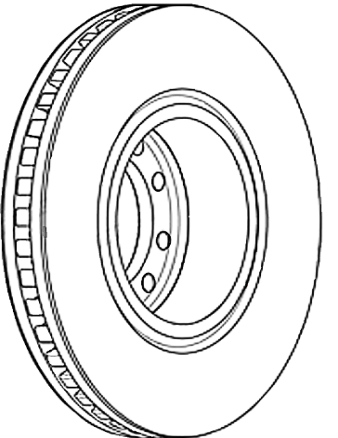
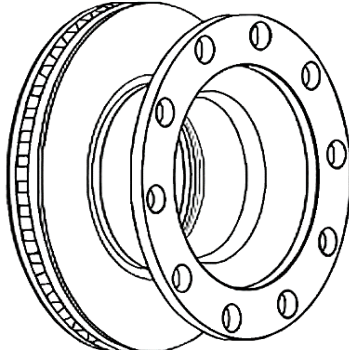
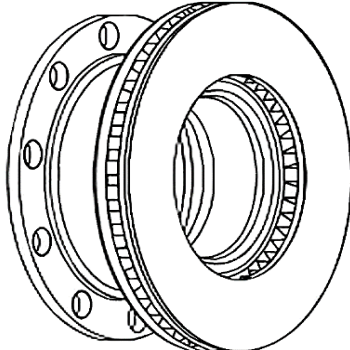
P:disque plein/solid disc

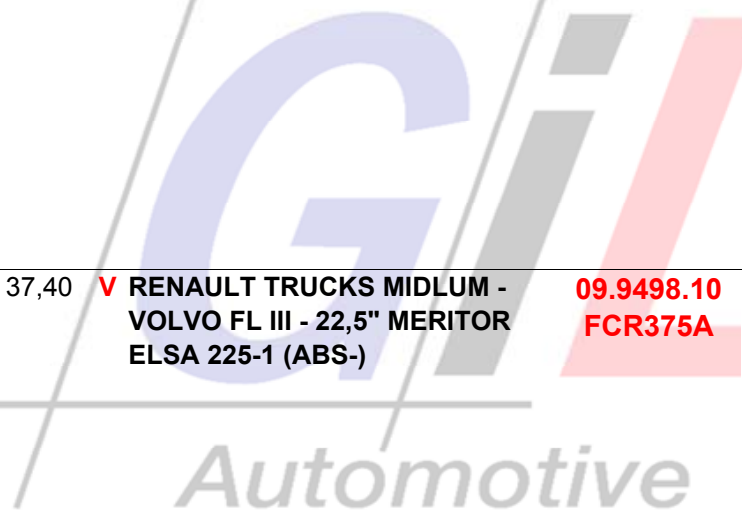
V:disque ventilé/vented disc

Les dessins de disque de frein proviennent/Brake disc drawing come from Federal Mogul



RECHERCHE DISQUES DE FREIN PAR DIMENSIONS BRAKE DISC RESEARCH BY SIZE

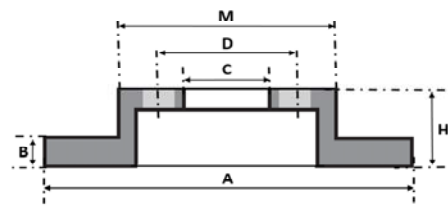
A	H	B	B min.	NB Trous/holes	D	C	M	FIXATION	KG	P V				ILLUSTRATIONS / DRAWINGS
410,0	92,8	45,0	37,0	10	165,0	131,0	220,0	2	29,20	V	RENAULT TRUCKS MIDLUM - VOLVO FL III - 22,5" MERITOR ELSA 225-1 (ABS-)	09.9497.10 FCR374A		
410,0	166,5	45,0	37,0	10	335,0	262,0	381,0		37,40	V	RENAULT TRUCKS MIDLUM - VOLVO FL III - 22,5" MERITOR ELSA 225-1 (ABS-)	09.9498.10 FCR375A		



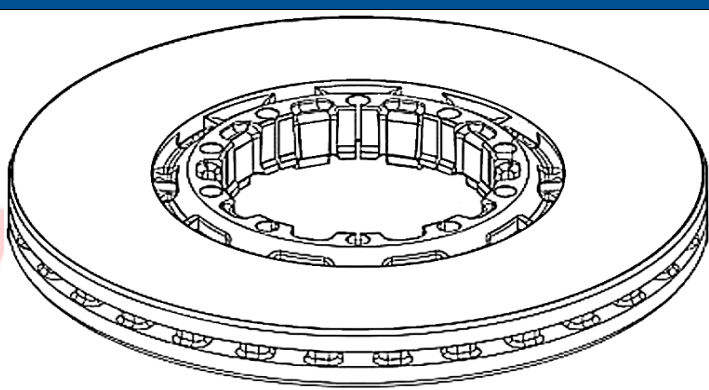
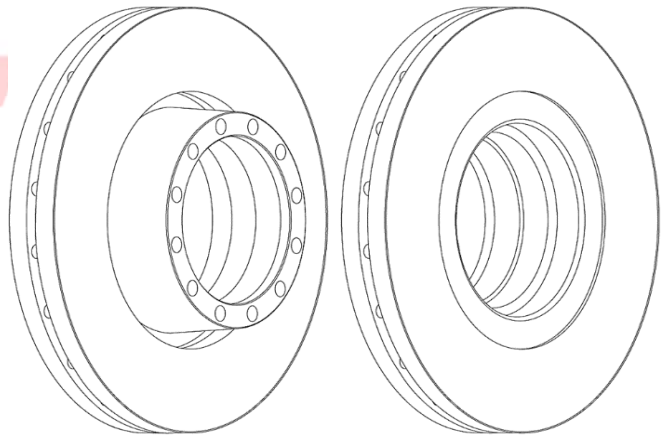
P:disque plein/solid disc

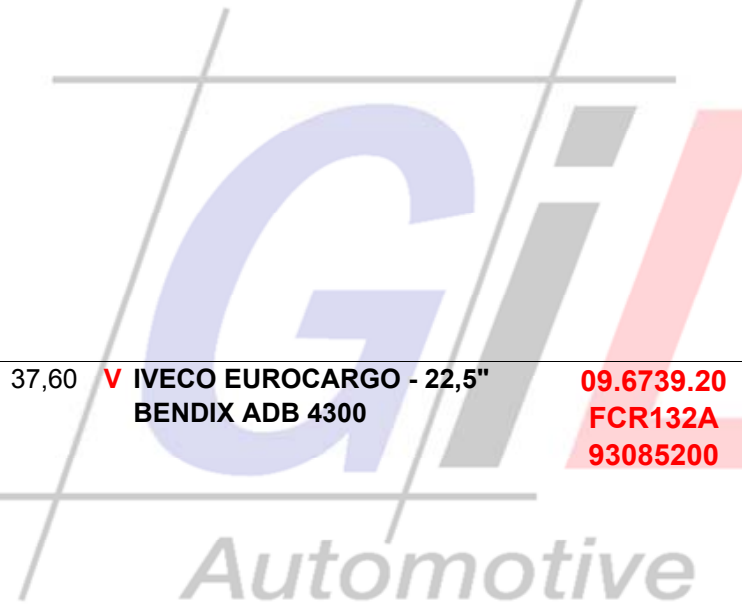
V:disque ventilé/vented disc

Les dessins de disque de frein proviennent/Brake disc drawing come from Federal Mogul



RECHERCHE DISQUES DE FREIN PAR DIMENSIONS BRAKE DISC RESEARCH BY SIZE

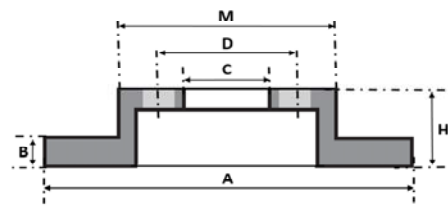
A	H	B	B min.	NB Trous/holes	D	C	M	FIXATION	KG	P V		ILLUSTRATIONS / DRAWINGS
430,0	47,9	45,0	37,0	10	190,0	170,4	213,7		28,10	V	SAF INTEGRAL - 22,5" KNORR SB-SN7 AXIAL	09.E155.10 93193500 
430,0	102,0	50,0	46,0	12	195,0	170,0	219,0	2	37,60	V	IVECO EUROCARGO - 22,5" BENDIX ADB 4300	09.6739.20 FCR132A 93085200 





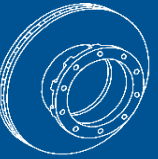
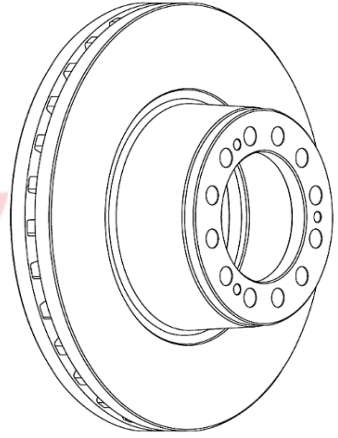
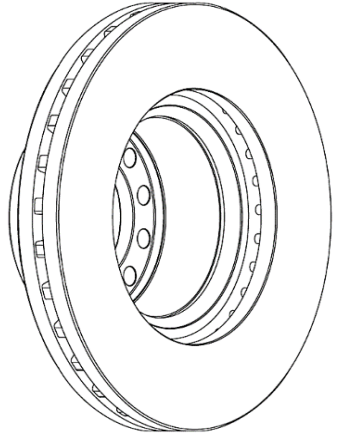
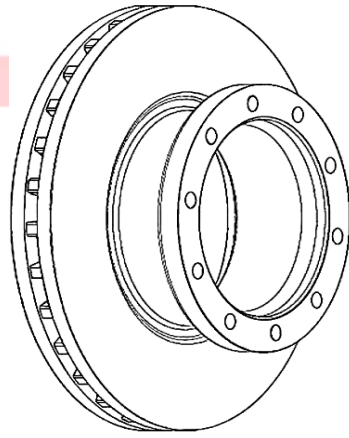
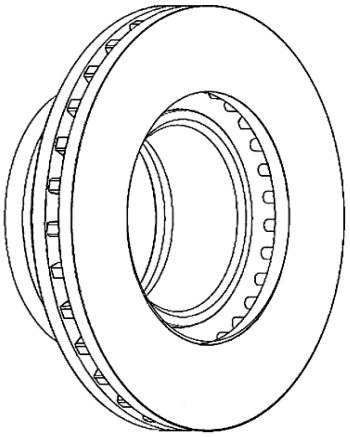
P:disque plein/solid disc

V:disque ventilé/vented disc

Les dessins de disque de frein proviennent/Brake disc drawing come from Federal Mogul



RECHERCHE DISQUES DE FREIN PAR DIMENSIONS BRAKE DISC RESEARCH BY SIZE

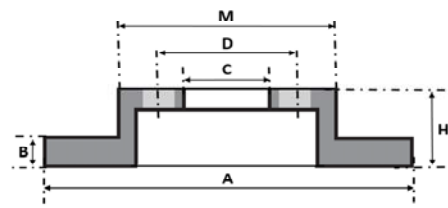
A	H	B	B min.	NB Trous/holes	D	C	M	FIXATION	KG	P V				ILLUSTRATIONS / DRAWINGS
430,0	129,9	45,0	37,0	12	168,0	131,0	217,8	3	33,00	V	SAF SK RB 9022 H - (MERCEDES DISCOS) JOST - SCHMITZ - 22,5" HALDEX DB 22 (ABS-)	09.8793.10 FCR201A 93101800		
430,0	131,0	45,0	37,0	10	235,0	200,0	272,0		33,90	V	NEOPLAN - 22,5" KNORR SB-SN7 AXIAL	FCR167A 93086700		





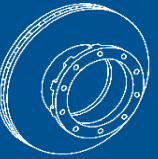
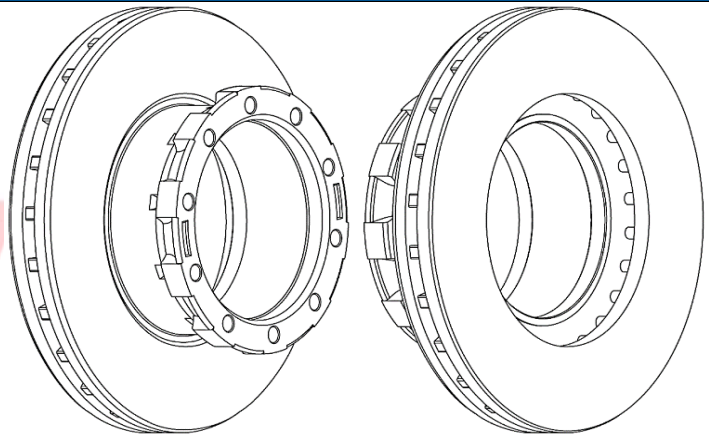
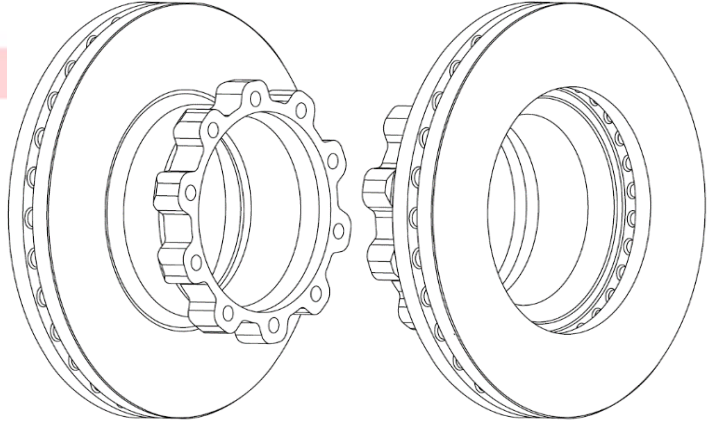
P:disque plein/solid disc

V:disque ventilé/vented disc

Les dessins de disque de frein proviennent/Brake disc drawing come from Federal Mogul



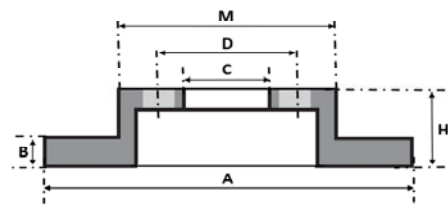
RECHERCHE DISQUES DE FREIN PAR DIMENSIONS BRAKE DISC RESEARCH BY SIZE

A	H	B	B min.	NB Trous/holes	D	C	M	FIXATION	KG	P V				ILLUSTRATIONS / DRAWINGS
430,0	131,0	45,0	37,0	10	235,0	203,1	271,0		33,40	V	BOVA, NEOPLAN, SOLARIS - 22,5" KNORR SB-SN7 AXIAL (ABS-)		09.B325.40 FCR168A 93086800	
430,0	131,0	45,0	37,0	10	237,0	208,0	270,0		31,00	V	SCANIA 4 SERIES - 22,5" KNORR SB-SN7 (ABS-)		DF70003 09.A995.10 FCR170A 93088300	



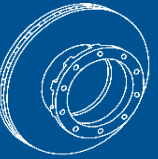
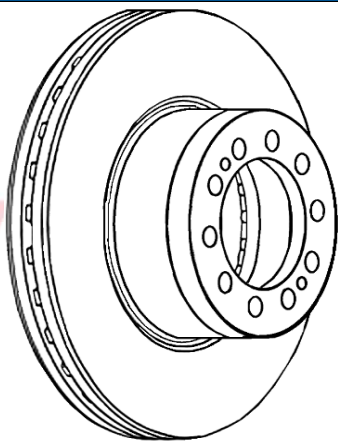
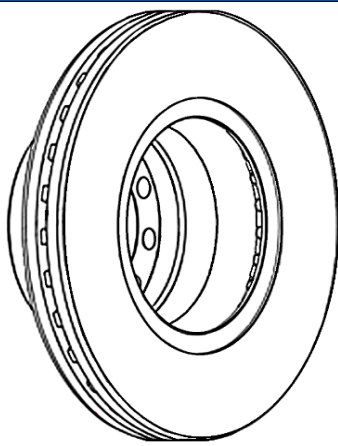
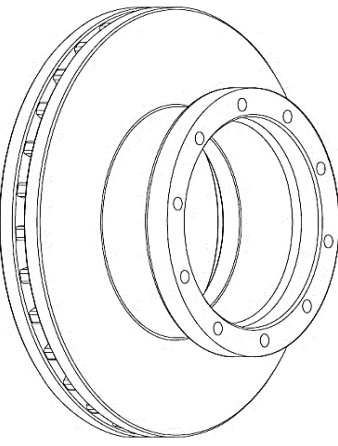
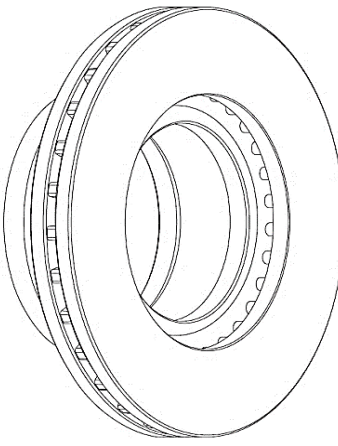


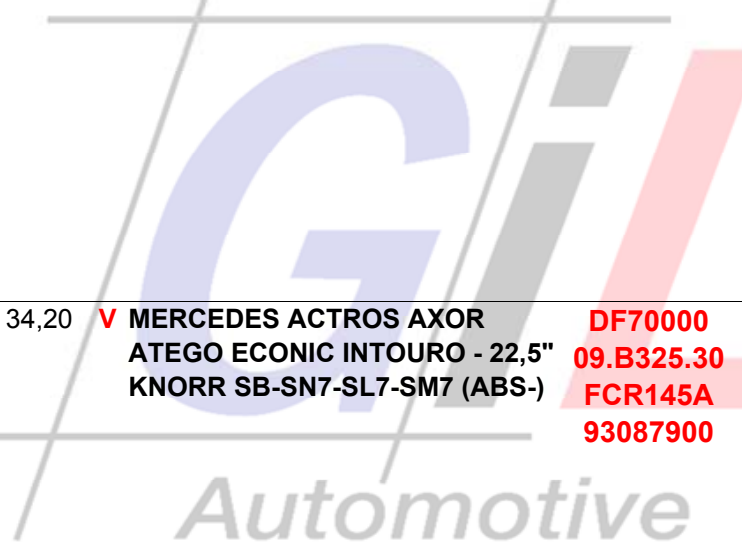
P:disque plein/solid disc
V:disque ventilé/vented disc

Les dessins de disque de frein proviennent/Brake disc drawing come from Federal Mogul



RECHERCHE DISQUES DE FREIN PAR DIMENSIONS BRAKE DISC RESEARCH BY SIZE

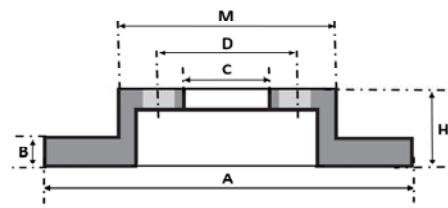
A	H	B	B min.	NB Trous/holes	D	C	M	FIXATION	KG	P V				ILLUSTRATIONS / DRAWINGS	
430,0	131,5	45,0	37,0	10	168,0	131,0	230,0		34,40	V	MERCEDES ACTROS MP4	AROCS ECONIC 2 - 22,5" KNORR	SM7 (ABS-)	09.C311.10 FCR372A 93291200	 
430,0	132,5	45,0	37,0	10	238,0	211,1	269,0		34,20	V	MERCEDES ACTROS AXOR	ATEGO ECONIC INTOURO - 22,5"	KNORR SB-SN7-SL7-SM7 (ABS-)	DF70000 09.B325.30 FCR145A 93087900	 





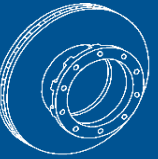


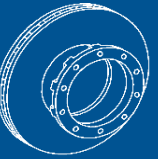
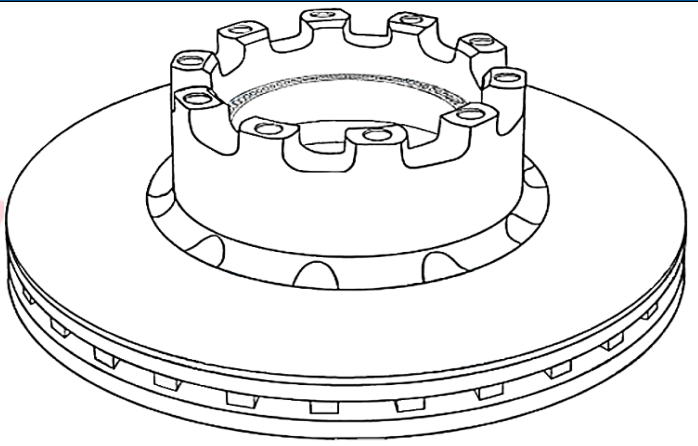


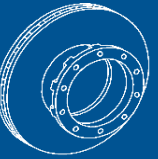
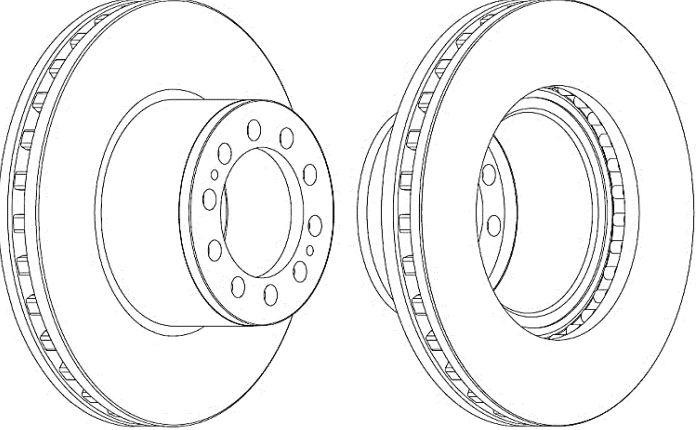
P:disque plein/solid disc

V:disque ventilé/vented disc

Les dessins de disque de frein proviennent/Brake disc drawing come from Federal Mogul



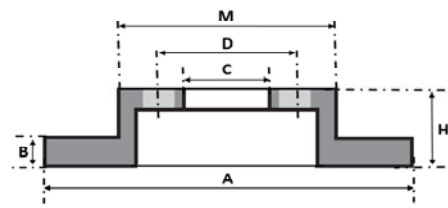
RECHERCHE DISQUES DE FREIN PAR DIMENSIONS BRAKE DISC RESEARCH BY SIZE

A	H	B	B min.	NB Trous/holes	D	C	M	FIXATION	KG	P V				ILLUSTRATIONS / DRAWINGS
430,0	136,0	45,0	37,0	10	193,0	164,0			33,00	V				
430,0	143,5	45,0	37,0	10	168,0	131,0	227,0	2	32,60	V				
V SAF (ABS+) - 22,5" KNORR ST7 AXIAL 09.E164.20														
V MERCEDES ACTROS AXOR ATEGO ECONIC INTOURO - 22,5" KNORR SB-SN7-SM7 (ABS-) DF70008 09.A741.10 FCR323A 93186700														



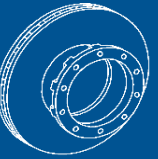
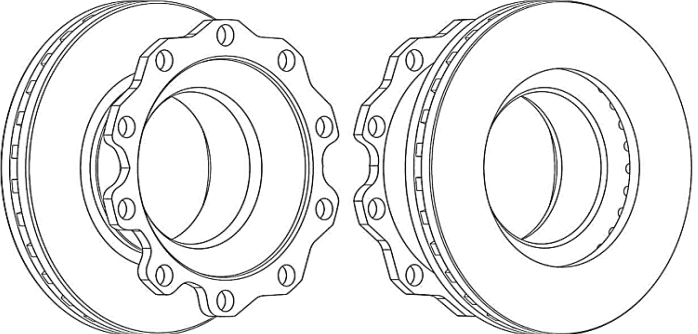
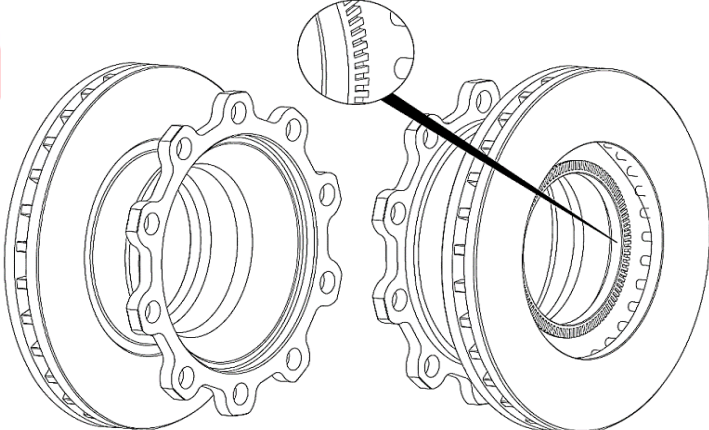
P:disque plein/solid disc

V:disque ventilé/vented disc

Les dessins de disque de frein proviennent/Brake disc drawing come from Federal Mogul



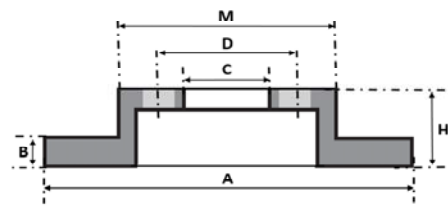
RECHERCHE DISQUES DE FREIN PAR DIMENSIONS BRAKE DISC RESEARCH BY SIZE

A	H	B	B min.	NB Trous/holes	D	C	M	FIXATION	KG	P V				ILLUSTRATIONS / DRAWINGS
430,0	155,0	45,0	37,0	10	335,0	280,0			37,00	V	GIGANT SMB - 22,5" HALDEX DB 22 LT	FCR362A		
430,0	155,0	45,0	37,0	10	335,0	280,0	382,0		37,40	V	SMB AXLES 22,5" WHEELS - 22,5" KNORR SB-SN7 WABCO HALDEX (ABS+ 100 dents/teeth)	09.8526.10 FCR199A 93102000		



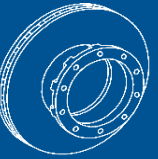
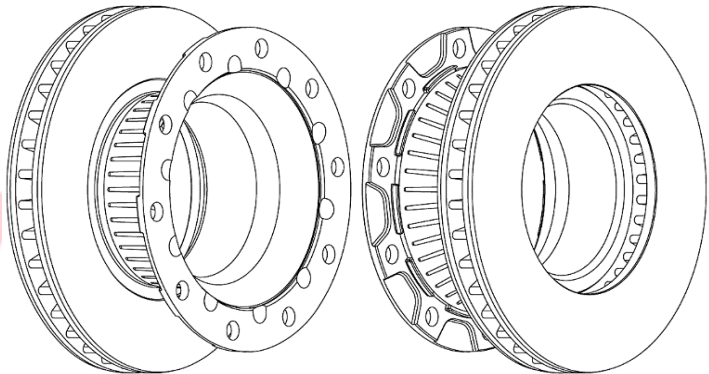
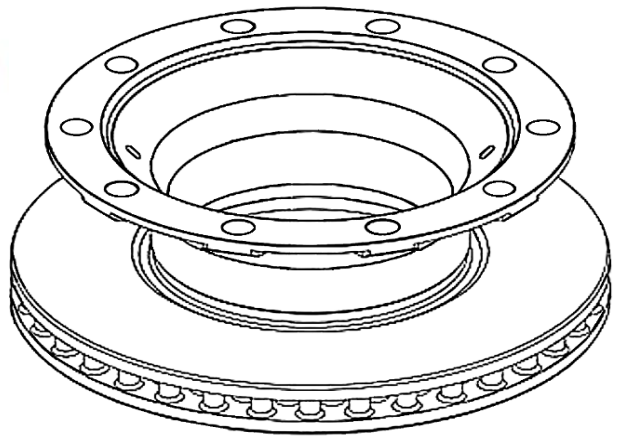
P:disque plein/solid disc

V:disque ventilé/vented disc

Les dessins de disque de frein proviennent/Brake disc drawing come from Federal Mogul



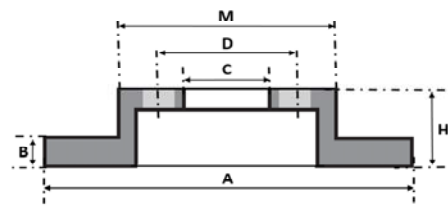
RECHERCHE DISQUES DE FREIN PAR DIMENSIONS BRAKE DISC RESEARCH BY SIZE

A	H	B	B min.	NB Trous/holes	D	C	M	FIXATION	KG	P V				ILLUSTRATIONS / DRAWINGS
430,0	159,5	45,0	37,0	10	335,0	299,0	320,0		33,60	V	BPW SB4309 SB4345 ECO PLUS	2 - 22,5" KNORR SK7-SN7; BPW ECO DISC (ABS-)	09.B072.10 FCR222A 93127100	
430,0	159,5	45,0	37,0	10	335,0				32,30	V	BPW SB4309 SB4345 ECO PLUS	3 - 22,5" KNORR SK7-SN7 BPW ECO DISC (ABS-)	DF713848	



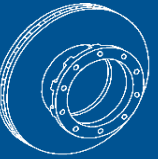


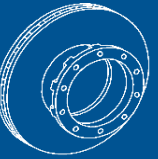


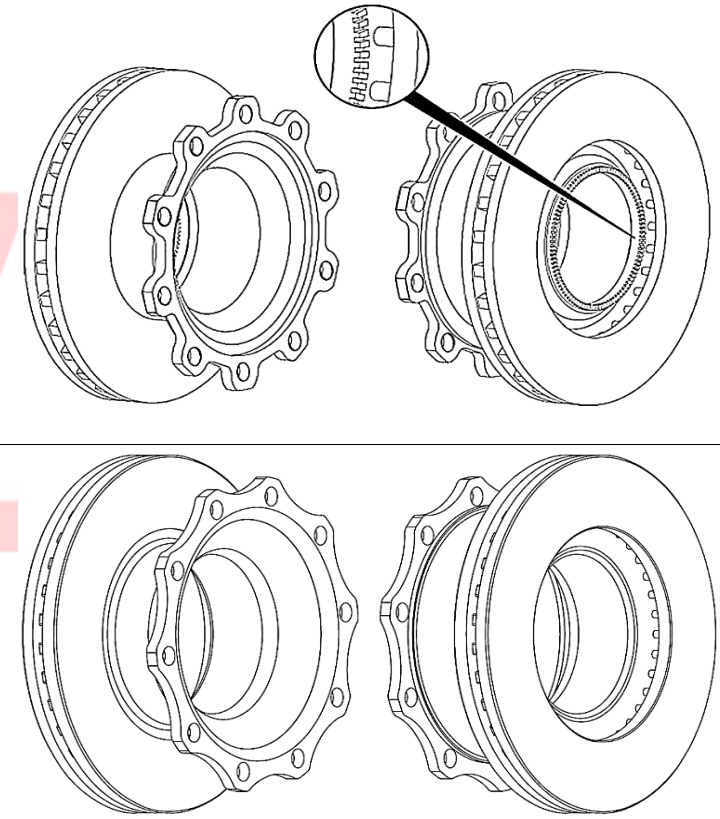
P:disque plein/solid disc
V:disque ventilé/vented disc

Les dessins de disque de frein proviennent/Brake disc drawing come from Federal Mogul



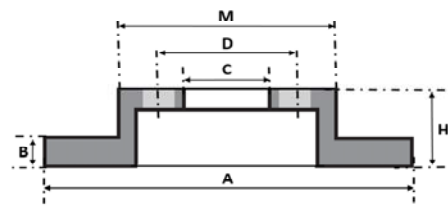
RECHERCHE DISQUES DE FREIN PAR DIMENSIONS BRAKE DISC RESEARCH BY SIZE

A	H	B	B min.	NB Trous/holes	D	C	M	FIXATION	KG	P V	Illustrations / Drawings
430,0	160,0	45,0	38,0	10	335,0	290,0	380,0		36,80	V	   V GIGANT PROTEC - 22,5" KNORR SB-SN7 AXIAL FCR294A 93193200
430,0	160,5	45,0	37,0	10	335,0	190,4	380,0		41,00	V	   V SAF SK 9022 SK 11222K - SCHMITZ - 22,5" KNORR SB-SN7 (ABS-) 09.8368.10 FCR203A 93101900



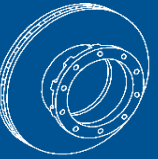



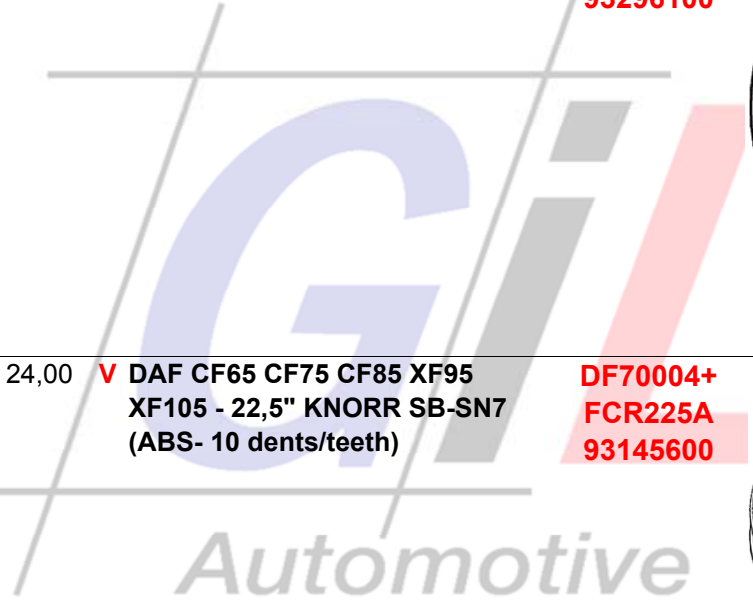
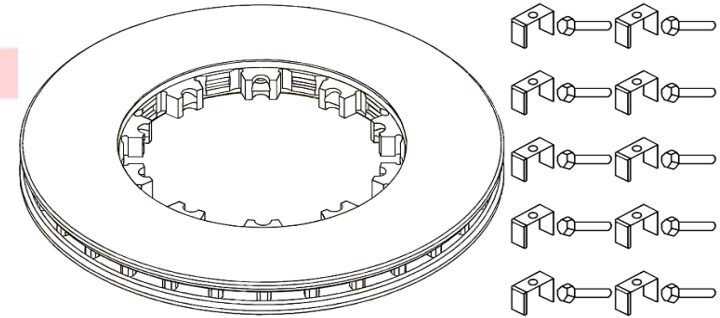
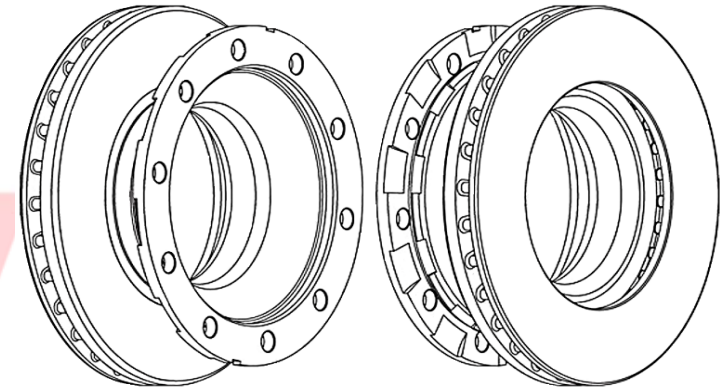
P:disque plein/solid disc
V:disque ventilé/vented disc

Les dessins de disque de frein proviennent/Brake disc drawing come from Federal Mogul



RECHERCHE DISQUES DE FREIN PAR DIMENSIONS BRAKE DISC RESEARCH BY SIZE

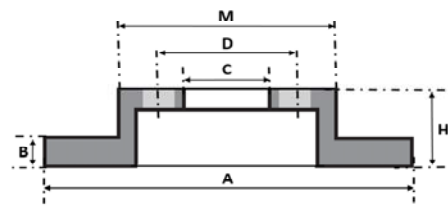
A	H	B	B min.	NB Trous/holes	D	C	M	FIXATION	KG	P V		ILLUSTRATIONS / DRAWINGS
430,0	168,5	45,0	37,0	10	335,0	290,0	386,0		36,00	V	  	09.9406.20 FCR336A 93296100
V SCHMITZ CARGOBULL - 22,5" KNORR SB-SN7 (ABS-)												
432,0	45,0	45,0	37,0		257,8				24,00	V		DF70004+ FCR225A 93145600
V DAF CF65 CF75 CF85 XF95 XF105 - 22,5" KNORR SB-SN7 (ABS- 10 dents/teeth)												





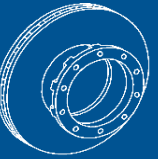
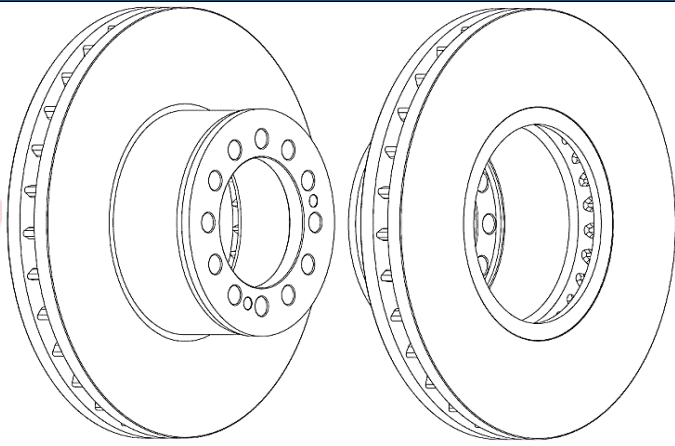
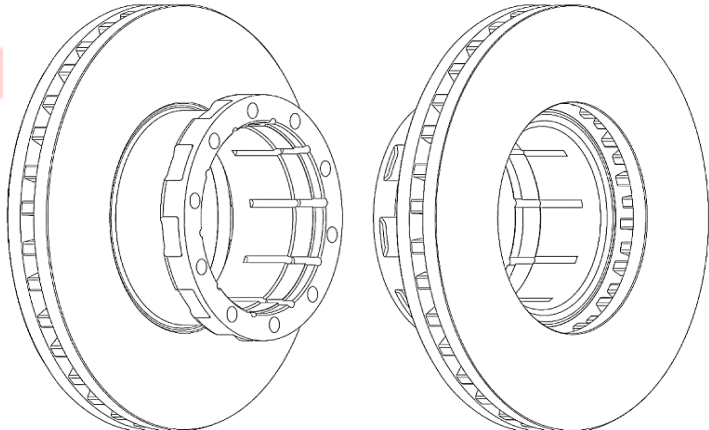
P:disque plein/solid disc

V:disque ventilé/vented disc

Les dessins de disque de frein proviennent/Brake disc drawing come from Federal Mogul



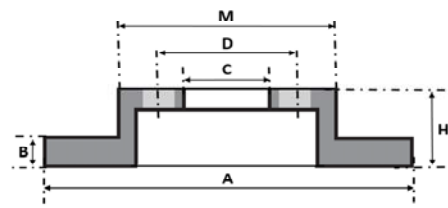
RECHERCHE DISQUES DE FREIN PAR DIMENSIONS BRAKE DISC RESEARCH BY SIZE

A	H	B	B min.	NB Troux/holes	D	C	M	FIXATION	KG	P V				ILLUSTRATIONS / DRAWINGS
432,0	130,0	45,0	35,0	12	168,0	131,0	239,2	2	36,60	V	MAN TGA TGM TGS TGX - 22,5"	DF70001	09.9435.10	
											KNORR SB-SN7 (ABS-)	FCR214A	93087200	
432,0	135,0	45,0	35,0	10	220,0	194,0	250,0		33,50	V	EVOBUS KASSBOHRER SETRA - 88 - 22,5"	09.8129.20	FCR114A	
											MERITOR D 3 (ABS-)	93058100		



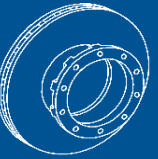
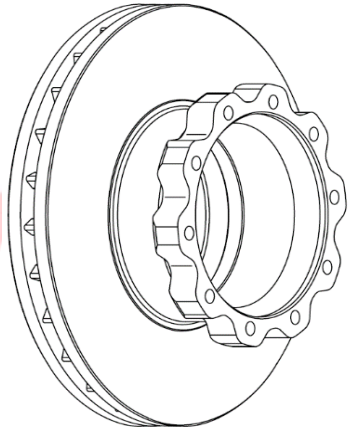
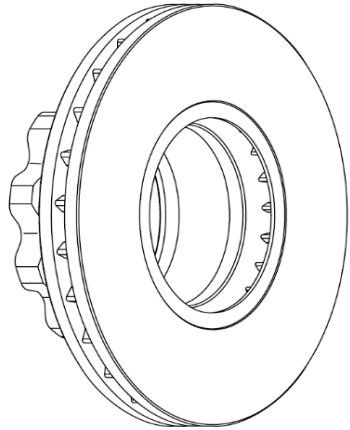
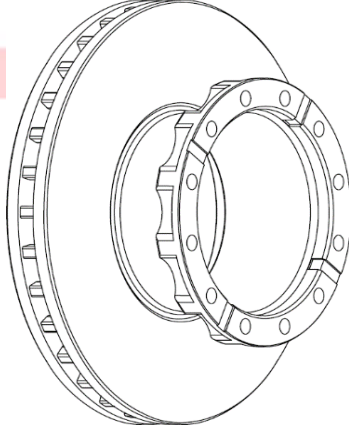
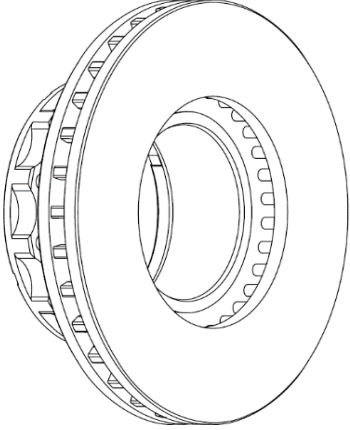


P:disque plein/solid disc
V:disque ventilé/vented disc

Les dessins de disque de frein proviennent/Brake disc drawing come from Federal Mogul



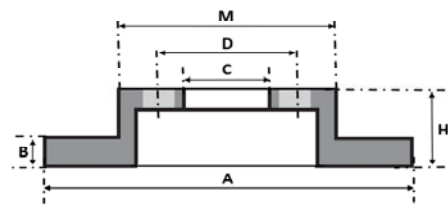
RECHERCHE DISQUES DE FREIN PAR DIMENSIONS BRAKE DISC RESEARCH BY SIZE

A	H	B	B min.	NB Trous/holes	D	C	M	FIXATION	KG	P V				ILLUSTRATIONS / DRAWINGS
432,0	135,0	45,0	37,0	10	235,0	208,0	270,0		36,50	V	MAN TGA TGM TGS TGX - 22,5"			 
														DF70002 09.9467.10 FCR215A 93087000
432,0	138,5	45,0	37,0	12	240,0	210,0	270,0		33,60	V	IVECO EUROTRAKKER STRALIS STRATOR TRAKKER - 22,5"			 
														DF70006 09.9983.10 FCR254A 93142900



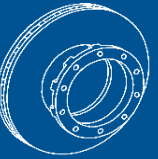


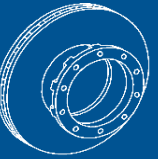
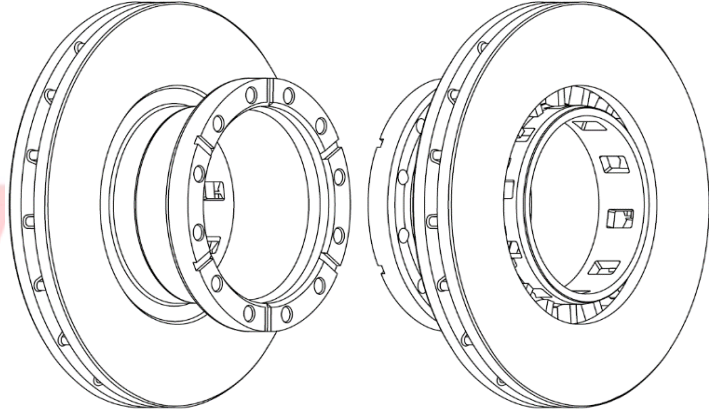
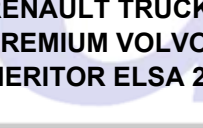
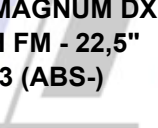
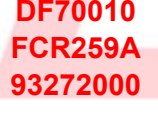
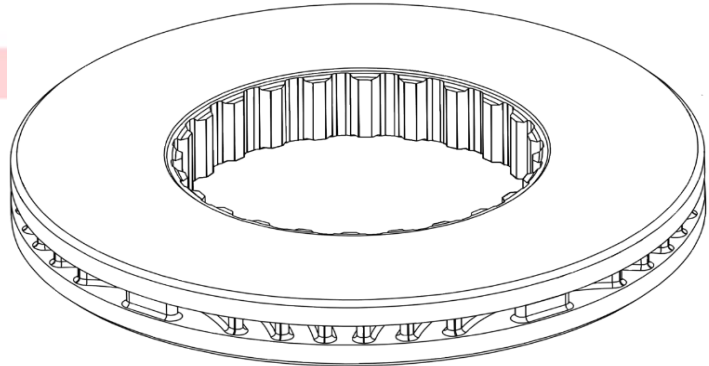


P:disque plein/solid disc
V:disque ventilé/vented disc

Les dessins de disque de frein proviennent/Brake disc drawing come from Federal Mogul



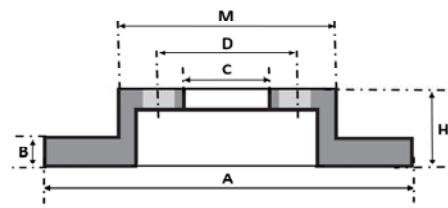
RECHERCHE DISQUES DE FREIN PAR DIMENSIONS BRAKE DISC RESEARCH BY SIZE

A	H	B	B min.	NB Trous/holes	D	C	M	FIXATION	KG	P V				ILLUSTRATIONS / DRAWINGS
432,0	154,3	45,0	37,0	12	240,0	210,0	270,0		37,20	V				 IVECO EUROTRAKKER STRALIS - 22,5" KNORR SB-SN7 (ABS+ 100 dents/teeth) DF70007 09.9983.60 FCR318A 93253000
434,0	45,0	45,0	41,0		220,0	220,0			27,50	V				 RENAULT TRUCKS MAGNUM DXI PREMIUM VOLVO FH FM - 22,5" MERITOR ELSA 225-3 (ABS-) DF70010 FCR259A 93272000



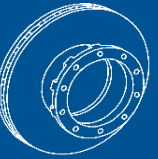
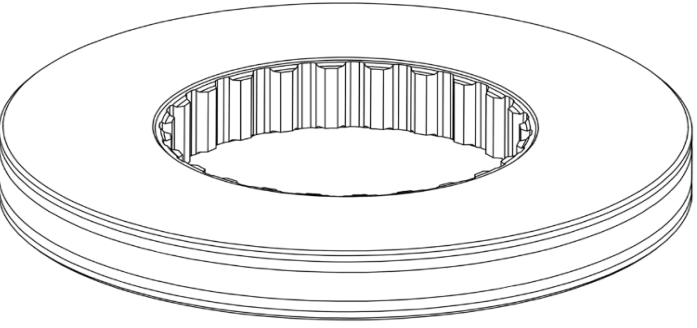
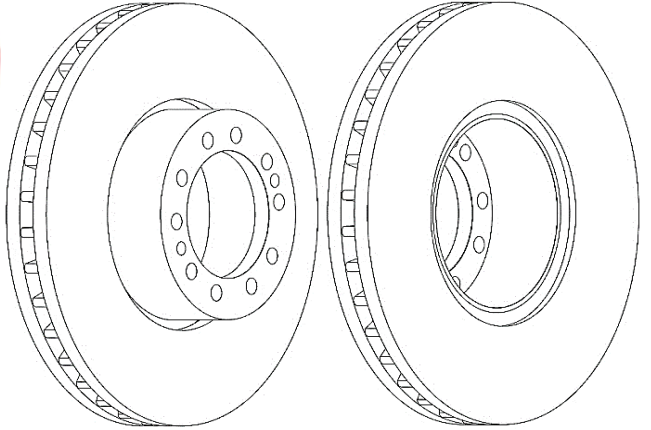


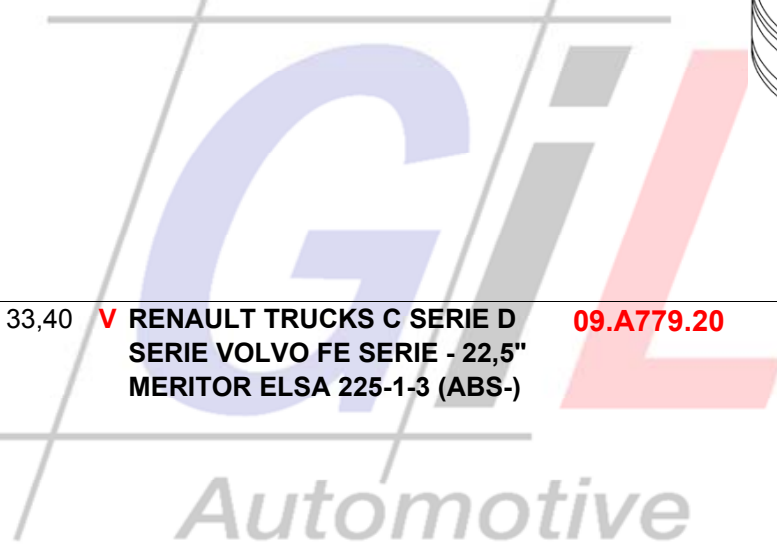
P:disque plein/solid disc
V:disque ventilé/vented disc

Les dessins de disque de frein proviennent/Brake disc drawing come from Federal Mogul



RECHERCHE DISQUES DE FREIN PAR DIMENSIONS BRAKE DISC RESEARCH BY SIZE

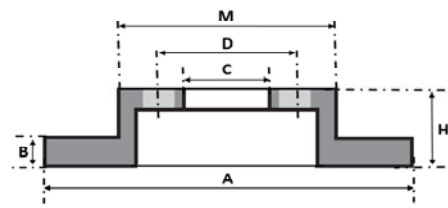
A	H	B	B min.	NB Troux/holes	D	C	M	FIXATION	KG	P V				ILLUSTRATIONS / DRAWINGS
434,0	45,0	45,0	41,0		220,0	220,0			35,50	P	RENAULT TRUCKS MAGNUM DXI		DF70005	
										V	PREMIUM VOLVO FH FM - 22,5"		FCR249A	
											MERITOR ELSA 225-3 (ABS-)		93272100	
434,0	96,4	45,0	37,0	10	165,0	131,0	216,0	2	33,40	V	RENAULT TRUCKS C SERIE D		09.A779.20	
											SERIE VOLVO FE SERIE - 22,5"			
											MERITOR ELSA 225-1-3 (ABS-)			





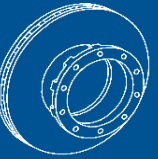
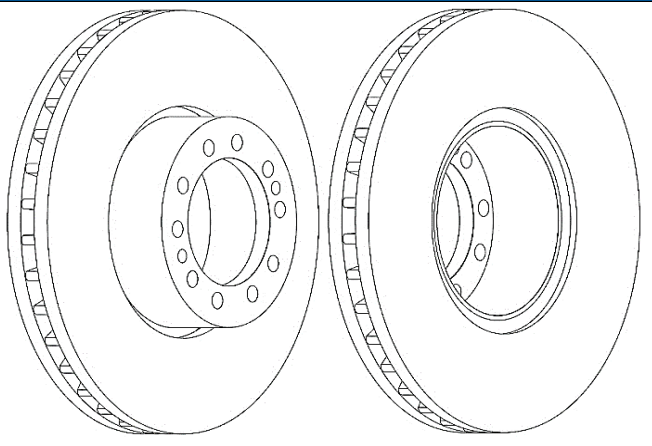
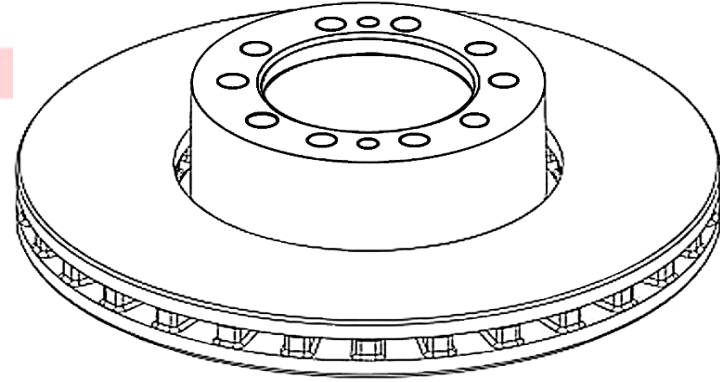
P:disque plein/solid disc

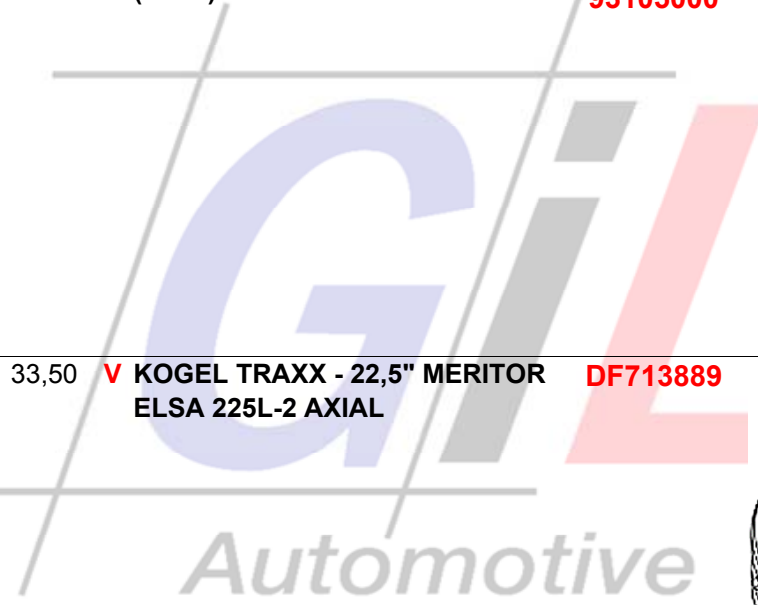
V:disque ventilé/vented disc

Les dessins de disque de frein proviennent/Brake disc drawing come from Federal Mogul



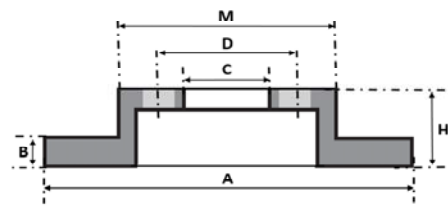
RECHERCHE DISQUES DE FREIN PAR DIMENSIONS BRAKE DISC RESEARCH BY SIZE

A	H	B	B min.	NB Trous/holes	D	C	M	FIXATION	KG	P V				ILLUSTRATIONS / DRAWINGS
434,0	96,7	45,0	41,0	10	165,0	131,0	218,0	2	42,00	V	RENAULT TRUCKS MAGNUM E-TECH - 22,5" MERITOR D ELSA 2 (ABS-)	09.8059.20 FCR244A 93105000		
434,0	109,0	45,0	39,0	10	165,0	131,0	194,0	2	33,50	V	KOGEL TRAXX - 22,5" MERITOR ELSA 225L-2 AXIAL	DF713889		



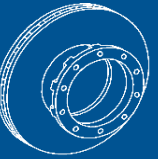
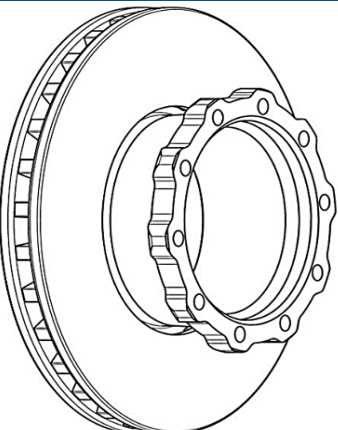
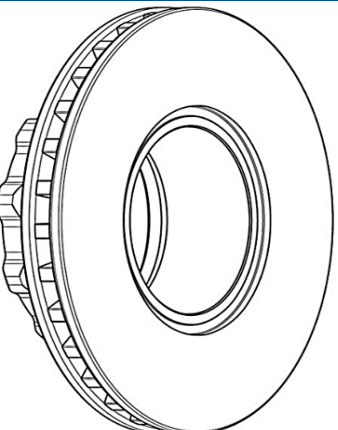
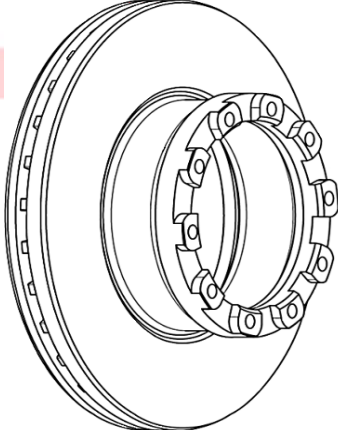
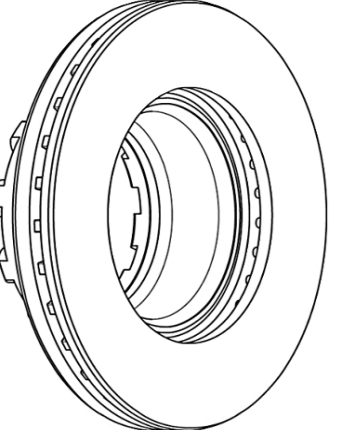


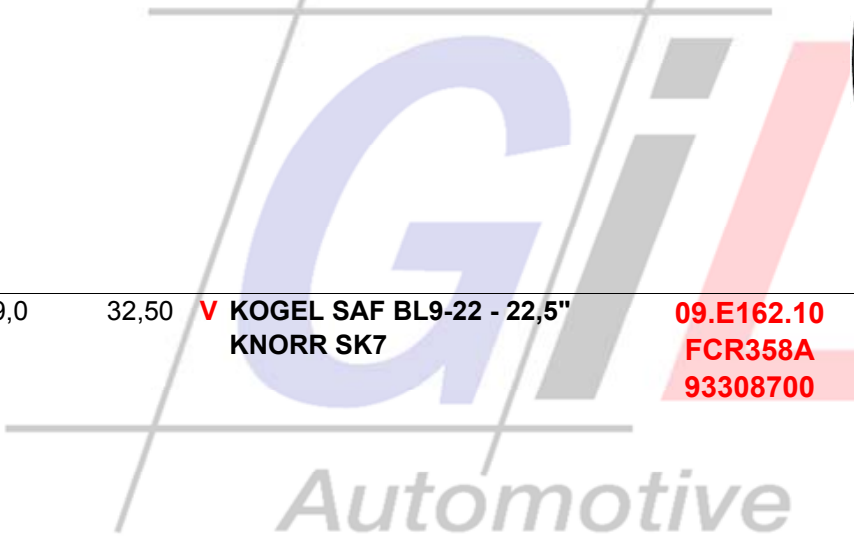
P:disque plein/solid disc
V:disque ventilé/vented disc

Les dessins de disque de frein proviennent/Brake disc drawing come from Federal Mogul



RECHERCHE DISQUES DE FREIN PAR DIMENSIONS BRAKE DISC RESEARCH BY SIZE

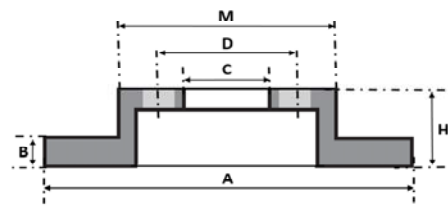
A	H	B	B min.	NB Trous/holes	D	C	M	FIXATION	KG	P V				ILLUSTRATIONS / DRAWINGS
434,0	130,0	45,0	37,0	10	235,0	203,2	270,0		35,80	V	IRISBUS URBANWAY VOLVO B12 - 22,5" KNORR SB-SN7 MERITOR 225-3		09.E161.10 FCR353A	 
430,0	131,5	45,0	37,0	10	215,0	189,1	239,0		32,50	V	KOGEL SAF BL9-22 - 22,5" KNORR SK7		09.E162.10 FCR358A 93308700	 





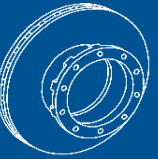


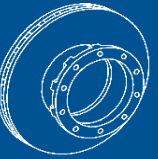
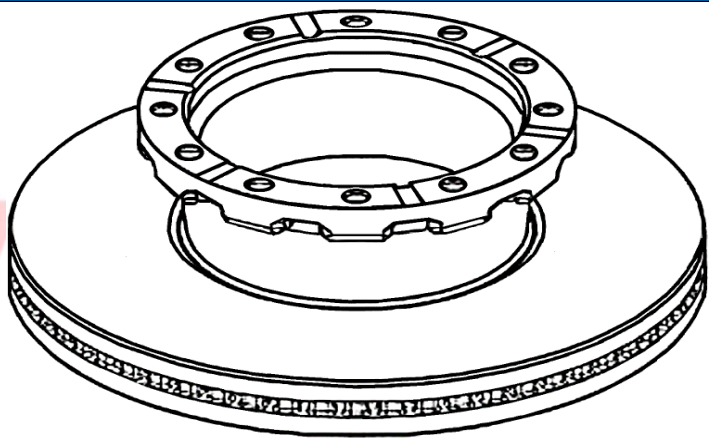


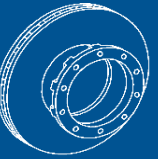
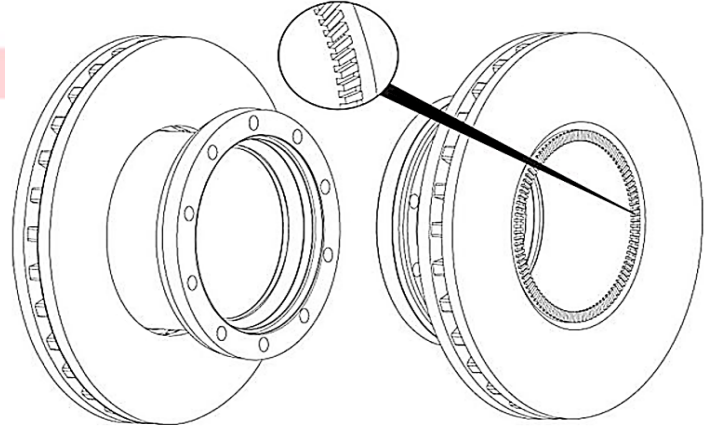
P:disque plein/solid disc

V:disque ventilé/vented disc

Les dessins de disque de frein proviennent/Brake disc drawing come from Federal Mogul



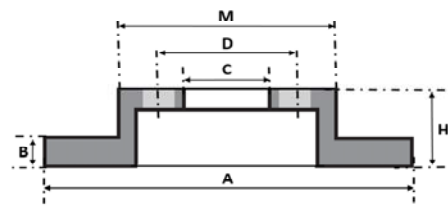
RECHERCHE DISQUES DE FREIN PAR DIMENSIONS BRAKE DISC RESEARCH BY SIZE

A	H	B	B min.	NB Trous/holes	D	C	M	FIXATION	KG	P V				ILLUSTRATIONS / DRAWINGS
434,0	138,5	45,0	39,0	12	240,0	210,1	270,0		36,40	V				
											V IVECO CROSSWAY LE, MAGELYS, URBANWAY - 22,5" MERITOR & KNORR			09.B750.10
434,0	150,0	45,0	38,0	10	250,0	222,0	282,0		39,30	V				
											V ROR TRAXX KÖGEL - 22,5" MERITOR ELSA 225L-2 AXIAL (ABS+)			09.8579.10 FCR250A 93192700



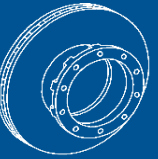


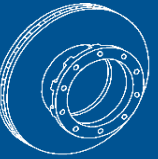
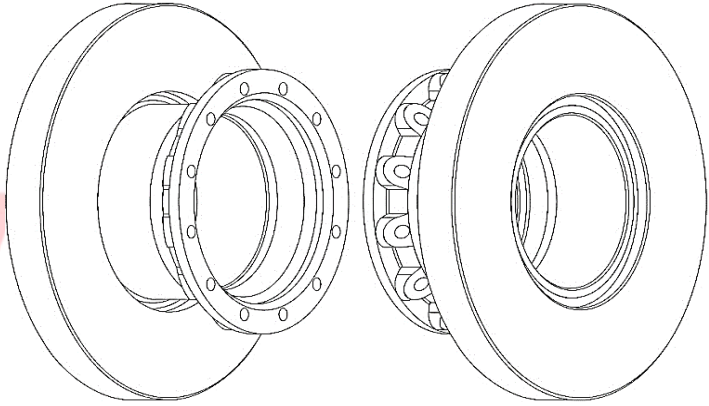


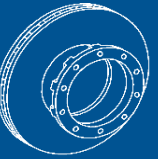
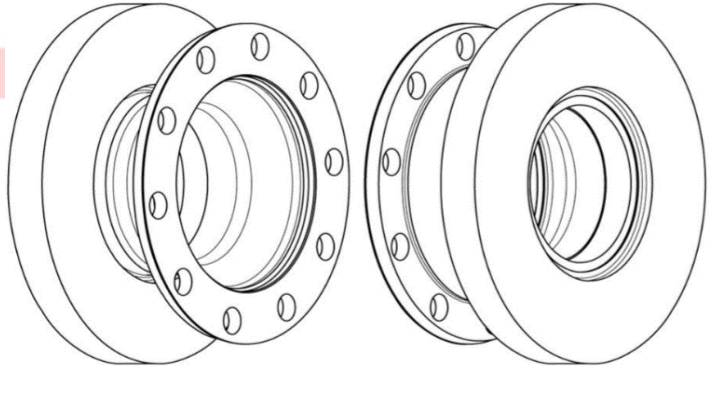
P:disque plein/solid disc

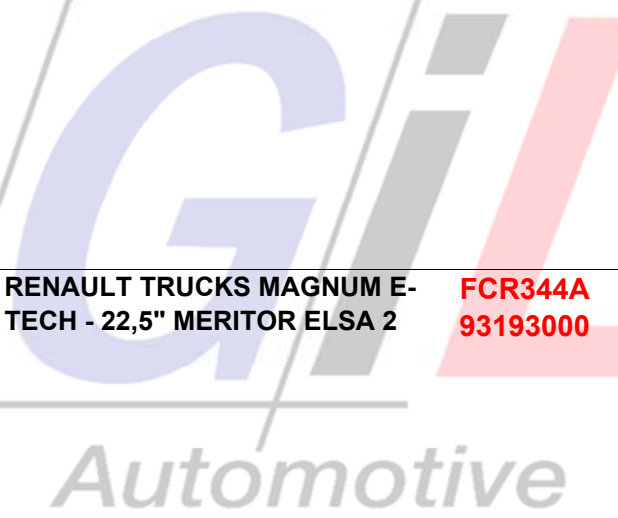
V:disque ventilé/vented disc

Les dessins de disque de frein proviennent/Brake disc drawing come from Federal Mogul



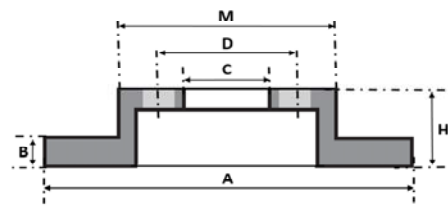
RECHERCHE DISQUES DE FREIN PAR DIMENSIONS BRAKE DISC RESEARCH BY SIZE

A	H	B	B min.	NB Trous/holes	D	C	M	FIXATION	KG	P V				ILLUSTRATIONS / DRAWINGS
434,0	160,0	45,0	40,0	12	256,0	224,2	290,0		47,64	P				
											RENAULT TRUCKS MAGNUM E-TECH - 22,5" MERITOR D ELSA 2 (ABS-) 08.8060.10 FCR245A 93105100			
434,0	163,0	45,0	39,0	10	335,0	260,0	387,0		52,50	P				
											RENAULT TRUCKS MAGNUM E-TECH - 22,5" MERITOR ELSA 2 FCR344A 93193000			



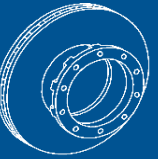
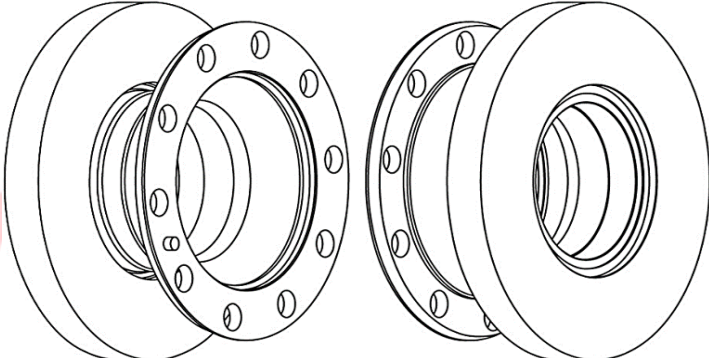
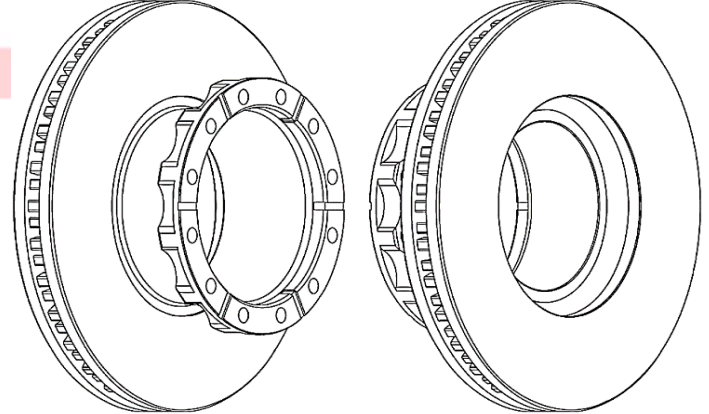


P:disque plein/solid disc
V:disque ventilé/vented disc

Les dessins de disque de frein proviennent/Brake disc drawing come from Federal Mogul



RECHERCHE DISQUES DE FREIN PAR DIMENSIONS BRAKE DISC RESEARCH BY SIZE

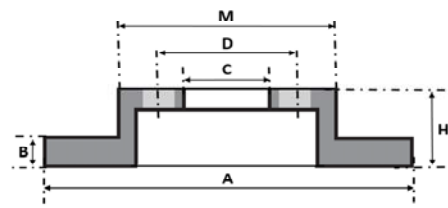
A	H	B	B min.	NB Troux/holes	D	C	M	FIXATION	KG	P V				ILLUSTRATIONS / DRAWINGS
434,0	170,0	45,0	34,0	10	335,0	264,0	1	51,66	P		RENAULT TRUCKS - 22,5"		FCR377A	
											MERITOR ELSA 2			
436,0	138,5	45,0	37,0	12	240,0	210,0	273,0	37,60	V		IVECO EURORIDER		09.9983.40	
											EUROCARGO EUROTECH		FCR173A	
											EUROSTAR - 22,5" KNORR SB-SN7 (ABS-)		93096100	





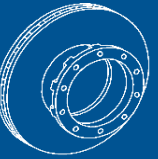
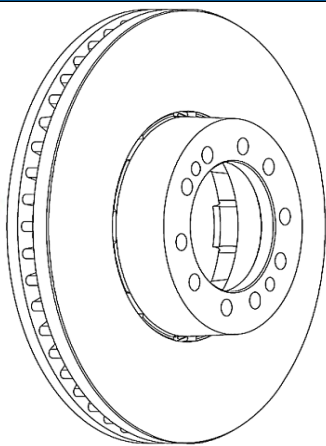
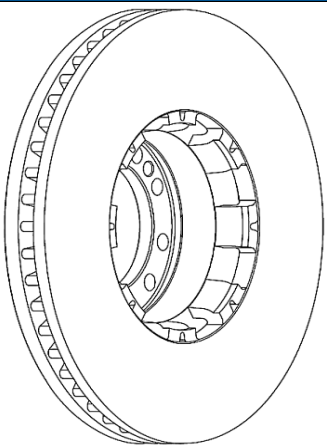
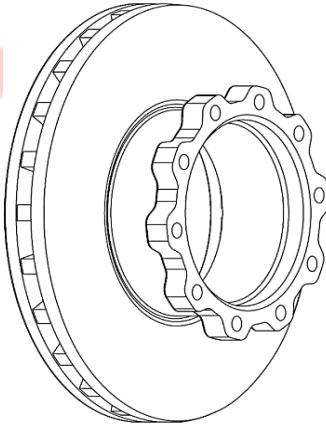
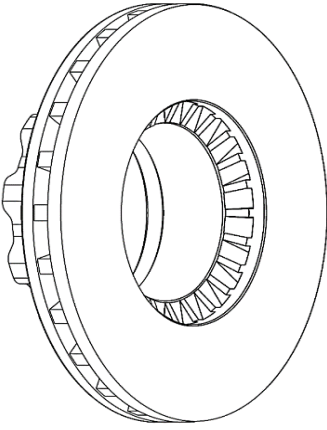
P:disque plein/solid disc

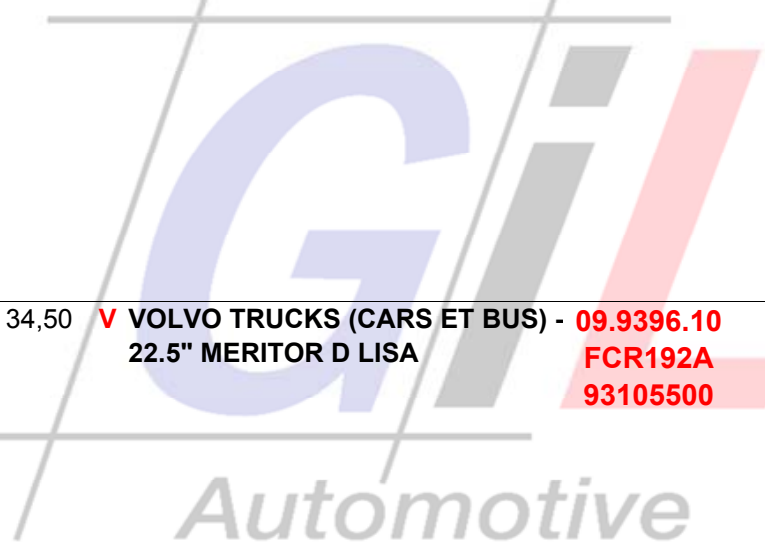
V:disque ventilé/vented disc

Les dessins de disque de frein proviennent/Brake disc drawing come from Federal Mogul



RECHERCHE DISQUES DE FREIN PAR DIMENSIONS BRAKE DISC RESEARCH BY SIZE

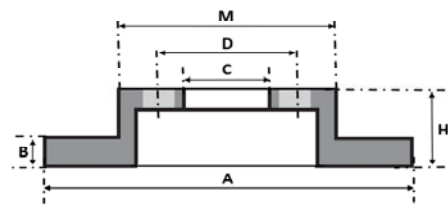
A	H	B	B min.	NB Trous/holes	D	C	M	FIXATION	KG	P V				ILLUSTRATIONS / DRAWINGS
438,0	97,0	45,0	41,0	10	165,0	131,0	218,0	2	31,60	V	RENAULT TRUCKS MAGNUM AE MAJOR R MANAGER G SERIES BUS - IRISBUS - 22,5" MERITOR (ABS-)	09.7870.10 FCR134A 93086100		
438,0	127,0	45,0	37,0	10	235,0	195,1	266,0		34,50	V	VOLVO TRUCKS (CARS ET BUS) - 22.5" MERITOR D LISA	09.9396.10 FCR192A 93105500		





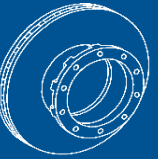
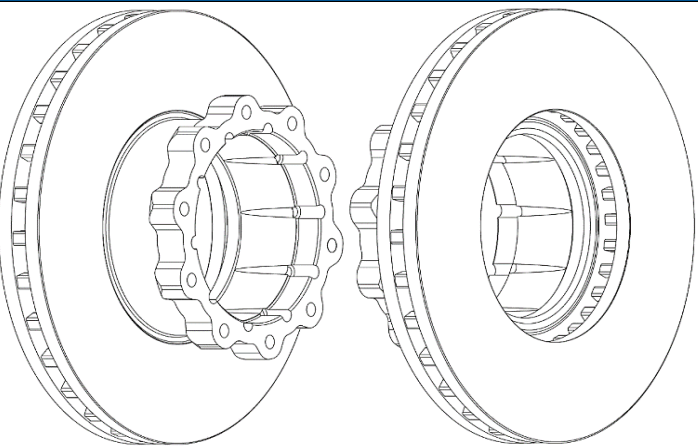
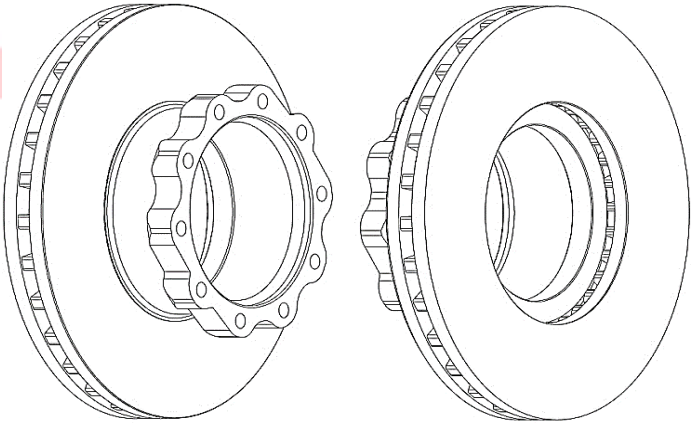
P:disque plein/solid disc

V:disque ventilé/vented disc

Les dessins de disque de frein proviennent/Brake disc drawing come from Federal Mogul



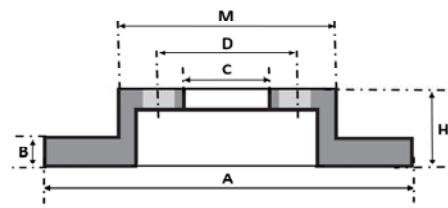
RECHERCHE DISQUES DE FREIN PAR DIMENSIONS BRAKE DISC RESEARCH BY SIZE

A	H	B	B min.	NB Trous/holes	D	C	M	FIXATION	KG	P V				ILLUSTRATIONS / DRAWINGS
438,0	135,0	45,0	41,0	10	235,0	195,1	270,0		33,30	V	MERCEDES (CARS ET BUS) - 22,5" MERITOR D3 (ABS-)		09.8129.10 FCR120A 93058200	
438,0	135,0	45,0	35,0	10	235,0	200,0	270,0		35,50	V	MAN LION'S CITY F2000 SERIES - VAN HOOL - 22,5" KNORR SB7 MERITOR D ELSA 2 (ABS-)		09.7320.10 FCR144A 93071800	



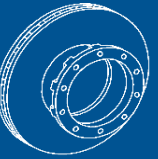
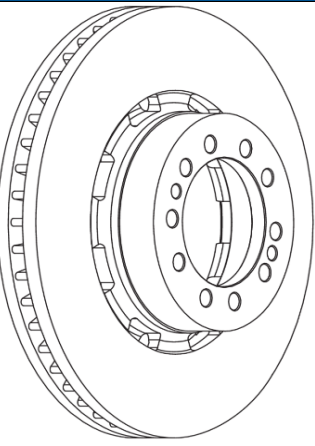
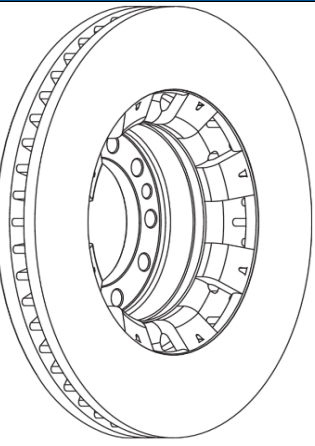
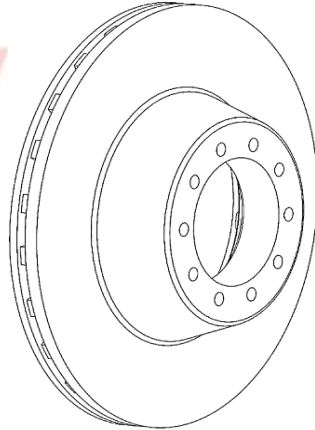
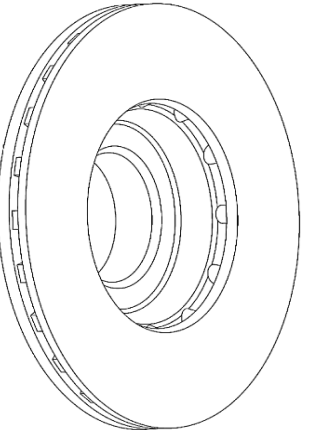


P:disque plein/solid disc
V:disque ventilé/vented disc

Les dessins de disque de frein proviennent/Brake disc drawing come from Federal Mogul



RECHERCHE DISQUES DE FREIN PAR DIMENSIONS BRAKE DISC RESEARCH BY SIZE

A	H	B	B min.	NB Trous/holes	D	C	M	FIXATION	KG	P V				ILLUSTRATIONS / DRAWINGS
440,0	100,0	44,4	39,0	10	165,0	131,0	222,0	2	29,10	V	RENAULT TRUCKS MAGNUM AE MAJOR R MANAGER G SERIES - 22,5" MERITOR D2 (ABS-)	FCR128A 93086000		
460,0	119,0	48,0	40,0	10	195,0	170,0	225,0		35,50	V	BOVA FUTURA DAF MB, SB, SBR - 22,5" KNORR SB-SN7 AXIAL	FCR100A 93084000		

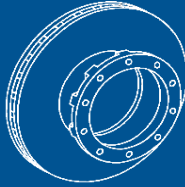
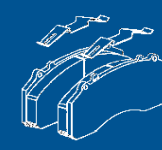
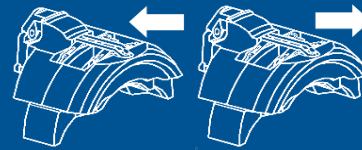
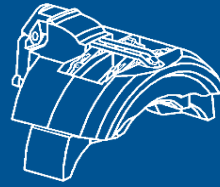


P:disque plein/solid disc

V:disque ventilé/vented disc

Les dessins de disque de frein proviennent/Brake disc drawing come from Federal Mogul

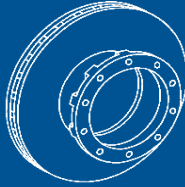
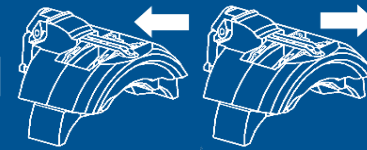
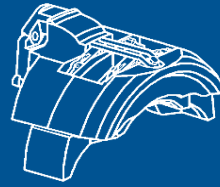
APPLICATION PAR VEHICULES
APPLICATION BY VEHICLES



BERKHOF VDL (CARS ET BUS)

AMBASSADOR (ALE106-205; ALE120-205) 07.07-	22,5" KNORR SB-SN7	AV/F	EFR73XX	EFR73XX	2920200764 2927802
		AR/R	EFR73XX	EFR73XX	292530539
AXIAL 50 12M 01.91-12.96	22,5" MERITOR D2	AV/F	EFR7710	EFR7711	2904303
AXIAL 50 12M 01.97-	22,5" MERITOR D LISA	AV/F	EFR7612	EFR7613	2909009 CVP023K
AXIAL 100DD 01.11-	22,5" KNORR SB-SN7 AXIAL (0°)	AV/F	EFR7303	EFR7302	2920200764 2927802
		AR/R	EFR7301	EFR7300	292530539
EXCELLENCE 3000HD (Chassis SCANIA) 01.97-	22,5" KNORR SB-SN7 AXIAL (0°)	AV/F	EFR7303	EFR7302	2920200764 2927802
		AR/R			292530539
RADIAL 12M 01.91-12.96	22,5" MERITOR D2	AV/F	EFR7710	EFR7711	2904303
RADIAL 12M 01.97-	22,5" MERITOR D LISA	AV/F	EFR7612	EFR7613	2909009 CVP023K
BMC					
ALYOS 01.09-	22,5" KNORR SB-SN7 AXIAL (0°)	AV/F	EFR7302	EFR7303	2920200764 2927802
		AR/R			292530539
MIDILUX 01.09-	17,5" WABCO PAN 17	AV/F	EFR5006	EFR5007	2928504
		AR/R			CVP032K
PROBUS (850) 01.09-	19,5" KNORR SB-SN6 AXIAL (5°+)	AV/F	EFR6300	EFR6301	2932002
		AR/R			CVP036K
SCHOOL BUS (1100 FE) 01.03-	17,5" WABCO PAN 17	AV/F	EFR5006	EFR5007	2928504
		AR/R			CVP032K

APPLICATION PAR VEHICULES
APPLICATION BY VEHICLES



BOVA (CARS ET BUS)

FUTURA (FHD10; FHD12; FHD13; FLD12; FLD14; FLD15) 11.92-12.01

22,5" KNORR SB-SN7
AXIAL (0°)

AV/F
AR/R

EFR7303

EFR7302

2920200764
2927802
292530539

FCR100A
93084000

FUTURA (FHD10; FHD12; FHD13; FHD104; FHD120; FHD127; FLD12; FLD13; FHD14 Magnum; FLD15 Magnum; FLD104; FLD120; FLD127) 12.01-

22,5" KNORR SB-SN7
AXIAL (0°)

AV/F

EFR7303

EFR7302

2920200764
2927802
292530539

09.B325.40
FCR168A
93086800

22,5" KNORR SB-SN7
AXIAL (-12°)

AR/R

EFR7301

EFR7300

LEXIO (LD123; LD130; LLD123-310; LLD123-365; LLD130-310; LLD130-365) (4x2) 09.05-

22,5" KNORR SB-SN7
AXIAL (0°)

AV/F

EFR7303

EFR7302

2920200764
2927802
292530539

22,5" KNORR SB-SN7
AXIAL (-12°)

AR/R

EFR7301

EFR7300

MAGIQ (HD120; HD122; HD131 Magnum; HD139 Magnum; MHD122; MHD131 Magnum; MHD139 Magnum; MHD148 Magnum) (4x2 & 6x2 & 6x2/4) 10.99-

22,5" KNORR SB-SN7
AXIAL (0°)

AV/F

EFR7303

EFR7302

2920200764
2927802
292530539

22,5" KNORR SB-SN7
AXIAL (-12°)

AR/R

EFR7301

EFR7300

SYNERGY (DD130; DD138; SDD130; SSD141) (6x2 & 6x2/4) 09.04-

22,5" KNORR SB-SN7
AXIAL (0°)

AV/F

EFR7303

EFR7302

2920200764
2927802
292530539

22,5" KNORR SB-SN7
AXIAL (-12°)

AR/R

EFR7301

EFR7300

BPW (AXLE)

SB3308 BRAKE KNORR WH. 17.5"

17,5" KNORR SB-SN5
POTENTIO. O/F

EFR5302

EFR5303

2918302

SB3745 ECO MAX K-SERIE (ABS+) -04.03

19,5" KNORR SB-SN6
AXIAL (5°+)

EFR6300

EFR6301

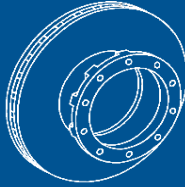
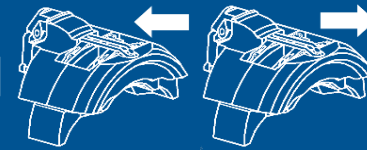
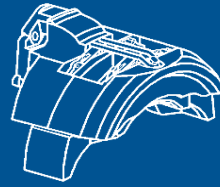
2930601

W0360SA
98028800

09.8486.20
FCR205A
93104900

Automotive

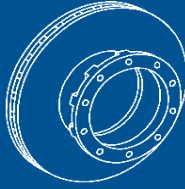
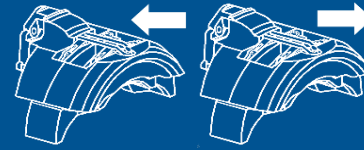
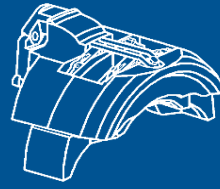
APPLICATION PAR VEHICULES
APPLICATION BY VEHICLES



BPW (AXLE) ../..

SB3745 ECO MAX K-SERIE (DISC ABS-) 05.03-	19,5"	KNORR SB-SN6 AXIAL (5°+)	EFR6300	EFR6301	2930601	W0360SA 98028800	09.A594.20 FCR252A 93126900
SB3745 ECO MAX K-SERIE (DISC ABS+) 05.03-	19,5"	KNORR SB-SN6 AXIAL (5°+)	EFR6300	EFR6301	2930601 TM	W0360SA 98028800	09.A594.20 FCR253A 93127000
SB3745 ECO PLUS K-SERIE (ABS-)RPP (ABS+) - 04.03	19,5"	KNORR SB-SN6 AXIAL (15°+)	EFR6302	EFR6303	2930601	W0360SA 98028800	09.8486.20 FCR205A 93104900
SB3745 ECO PLUS K-SERIE (DISC ABS-) 05.03-	19,5"	KNORR SB-SN6 AXIAL (15°+)	EFR6302	EFR6303	2930601	W0360SA 98028800	09.9900.10 FCR210A 92116500
SB3745 ECO PLUS K-SERIE (DISC ABS-) 05.03-	19,5"	KNORR SB-SN6 AXIAL (15°+)	EFR6302	EFR6303	2930601	W0360SA 98028800	09.A594.20 FCR252A 93126900
SB3745 ECO PLUS K-SERIE (DISC ABS+) 05.03-	19,5"	KNORR SB-SN6 AXIAL (15°+)	EFR6302	EFR6303	2930601	W0360SA 98028800	09.A594.20 FCR253A 93127000
SB3745 SKH SERIE UNI-DISC (ABS+) -04.03	19,5"	KNORR SB-SN6 AXIAL (15°+)	EFR6302	EFR6303	2930601	W0360SA 98028800	09.8486.20 FCR205A 93104900
SB3745 SKH SERIE UNI-DISC 05.03-	19,5"	KNORR SB-SN6 AXIAL (15°+)	EFR6302	EFR6303	2930601	W0360SA 98028800	09.A594.20 FCR252A 93126900
TSB3709 SKH; SKM SERIE (10 Trous/Holes ABS-) 01.11-	19,5"	BPW ECO DISC	EFR6950	EFR6951	2922701		09.A594.20 FCR252A 93126900

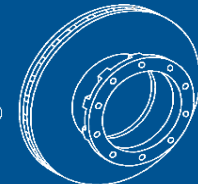
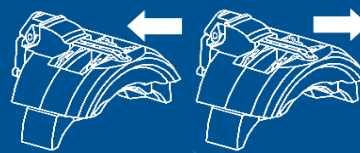
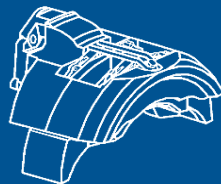
APPLICATION PAR VEHICULES
APPLICATION BY VEHICLES



BPW (AXLE) ../..

TSB3709 SKH; SKM SERIE (10 Trous/Holes ABS+) 01.11-	19,5" BPW ECO DISC	EFR6950	EFR6951	2922701	W0940SABP	09.A594.20 FCR253A 93127000
TS2 3709 SKH; SKM SERIE 04.19-	19,5" BPW ECO DISC	EFR6952	EFR6953	2940501		
SB4309; SB4309W ECO PLUS 2 01.00-	22,5" KNORR SK7	EFR6308	EFR6309	2930801 CVP094K	W0360SA 98028800	09.B072.10 FCR222A 93127100
SB4345 ECO PLUS 2 05.03-	22,5" KNORR SB-SN7 AXIAL (0°)	EFR7302	EFR7303	2930701 CVP093K	W0760BP 98028900	09.B072.10 FCR222A 93127100
SB4345 SH SERIE HD -04.03	22,5" KNORR SB-SN7 AXIAL (0°)	EFR7302	EFR7303	2930701 CVP093K	W0760BP 98028900	
SB4345 SH SERIE HD 05.03-	22,5" KNORR SB-SN7 AXIAL (0°)	EFR7302	EFR7303	2930701 CVP093K	W0760BP 98028900	09.B072.10 FCR222A 93127100
TSB4309 SH; SM SERIE ECO PLUS 2 01.11-	22,5" BPW ECO DISC	EFR7950	EFR7951	2922800604 2922801	W0940SABP	09.B072.10 FCR222A 93127100
TSB4309 SH; SM SERIE ECO PLUS 3 01.11-	22,5" BPW ECO DISC	EFR7950	EFR7951	2922800604 2922801	W0940SABP	DF713848
TSB4312 SH; SM SERIE ECO PLUS 2 01.11-	22,5" BPW ECO DISC	EFR7952	EFR7953	29267xx		09.B072.10 FCR222A 93127100
TSB4312 SH; SM SERIE ECO PLUS 3 01.11-	22,5" BPW ECO DISC	EFR7952	EFR7953	29267xx		DF713848
TS2 4309 SKH; SKM SERIE 04.19-	22,5" BPW ECO DISC	EFR7954	EFR7955	2940301		09.B072.10 FCR222A 93127100

APPLICATION PAR VEHICULES
APPLICATION BY VEHICLES



DAF (CARS ET BUS)

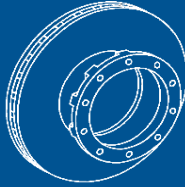
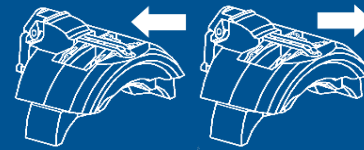
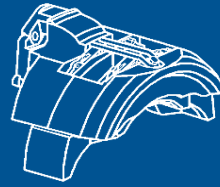
SB SERIES (SB120; SB180; SB200) 01.99-	19,5"	KNORR SB-SN6	AV/F	EFR6301	EFR6300	2932002	CVP036K	93187600	FCR283A
		AXIAL (5°+)	AR/R						
SB SERIES (SB4000) 01.98-	22,5"	KNORR SB-SN7	AV/F	EFR7308	EFR7309	2920200764	2927802	292530539	
		AXIAL (0°) POTENTIO.							
		O/F							
		KNORR SB-SN7	AV/F	EFR73xx	EFR73xx				
		AXIAL (0°)							

DAF (TRUCKS)

LF45 (FA45.130; FA45.140; FA45.150; FA45.160; FA45.160 HYBRID; FA45.170; FA45.180; FA45.210; FA45.220; FA45.250) (4x2) 01.01-04.13	17,5"	WABCO PAN 17	AV/F	EFR5002	EFR5003	2928502	CVP032K	W0330DA1	98031600	FCR256A
			AR/R							93142500
										ou/or
										09.E664.20
										FCR350A
										93187700
										FCR226A
										93187800
										ou/or
										DF713891
										(ABS+)
55 (FA55.150B13; FA55.180B13; FA55.180B15; FA55.210B13; FA55.210B15; FA55.230B13; FA55.230B15; FAG55.210B21) (4x2 & 6x2/4) 11.95- 12.00	19,5"	WABCO 1600 V-G	AV/F	EFR5004	EFR5005	2907702				FCR151A
										93105700

Automotive

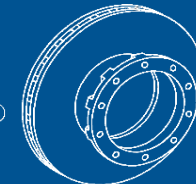
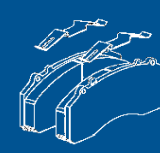
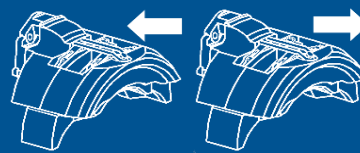
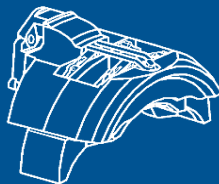
APPLICATION PAR VEHICULES
APPLICATION BY VEHICLES



DAF (TRUCKS) ..!

LF55 (FA55.180; FA55.220; FA55.250; FT55.180; FT55.220; FT55.250) 09.00-02.03	19,5" WABCO PAN 19-2	AV/F	EFR6002	EFR6003	29142 FCV1389	W0380DA1 98028600	09.9354.10 FCR257A 93142700
		AR/R					09.E452.20 FCR258A 93142800
LF55 (FA55.180; FA55.210; FA55.220; FA55.250; FA55.280; FA55.290) 02.03-04.13	19,5" WABCO PAN 19-1 Plus	AV/F	EFR6004	EFR6005	2931301	W0380DA1 98028600	
		AR/R					
LF (FA150; FA180; FA210; FA220; FA250; FA280; FA310) (4x2) 05.13-	19,5" WABCO PAN 19-1 Plus	AV/F	EFR6004	EFR6005	2931301	W0380DA1 98028600	
		AR/R					
LF55 (18 tonnes) (FA55.160; FA55.170; FA55.180; FA55.210; FA55.220; FA55.250; FA55.290; FA55.300; FAN55.180; FAN55.220; FAN55.250; FAN55.290) 05.01-04.06	22,5" KNORR SB-SN7 AXIAL (0°) POTENTIO. O/F	AV/F	EFR7308	EFR7309	2920200764 2927802 2927804TU+ 292530539		DF70004+ FCR225A 93145600
		AR/R					
LF55 (18 tonnes) (FA55.160; FA55.170; FA55.180; FA55.210; FA55.220; FA55.250; FA55.290; FA55.300; FAN55.180; FAN55.220; FAN55.250; FAN55.290) 05.06-	22,5" KNORR SB-SN7 AXIAL (0°) POTENTIO. O/F CLIP	AV/F	EFR7328	EFR7329	2920200764 2927802 2927804TU+ 292530539		DF70004+ FCR225A 93145600
		AR/R					
CF65 (FA65.180;FA65.220;FA65.250;FA65.290) (4x2) 05.01-04.06	22,5" KNORR SB-SN7 AXIAL (0°) POTENTIO. O/F	AV/F	EFR7308	EFR7309	2920200764 2927802 2927804TU+ 292530539		DF70004+ FCR225A 93145600
		AR/R					
CF65 (FA65.180;FA65.220;FA65.250;FA65.290) (4x2) 05.06-	22,5" KNORR SB-SN7 AXIAL (0°) POTENTIO. O/F CLIP	AV/F	EFR7328	EFR7329	2920200764 2927802 2927804TU+ 292530539		DF70004+ FCR225A 93145600
		AR/R					

APPLICATION PAR VEHICULES APPLICATION BY VEHICLES



DAF (TRUCKS) ..!..

CF75 (FA75.250; FA75.310; FA75.360; FAD75.250; FAD75.310; FAD75.360; FAG75.250; FAG75.310; FAG75.360; FAN75.250; FAN75.310; FAN75.360; FAR75.250; FAR75.310; FAR75.360; FAS75.250; FAS75.310; FAS75.360; FAT75.250; FAT75.310; FAT75.360; FT75.250; FT75.310; FT75.360) (4x2 & 6x2 & 6x2/4 & 6x4 & 8x4/4) 05.01-04.06

KNORR SB-SN7
22,5" AXIAL (0°) POTENTIO.
O/F

AV/F
AR/R

EFR7308 **EFR7309**

2920200764
2927802
2927804TU+
292530539

DF70004+
FCR225A
93145600

CF75 (FA75.250; FA75.310; FA75.360; FAD75.250; FAD75.310; FAD75.360; FAG75.250; FAG75.310; FAG75.360; FAN75.250; FAN75.310; FAN75.360; FAR75.250; FAR75.310; FAR75.360; FAS75.250; FAS75.310; FAS75.360; FAT75.250; FAT75.310; FAT75.360; FT75.250; FT75.310; FT75.360) (4x2 & 6x2 & 6x2/4 & 6x4 & 8x4/4) 05.06-

KNORR SB-SN7
22,5" AXIAL (0°) POTENTIO.
O/F CLIP

AV/F
AR/R

EFR7328 **EFR7329**

2920200764
2927802
2927804TU+
292530539

DF70004+
FCR225A
93145600

CF85 (FA85.340; FA85.360; FA85.380; FA85.410; FA85.430; FA85.460; FA85.480; FA85.510; FAC85.340; FAC85.360; FAC85.380; FAC85.410; FAC85.430; FAC85.460; FAC85.480; FAC85.510; FAD85.340; FAD85.360; FAD85.380; FAD85.410; FAD85.430; FAD85.460; FAD85.480; FAD85.510; FAG85.340; FAG85.360; FAG85.380; FAG85.410; FAG85.430; FAG85.460; FAG85.480; FAG85.510; FAN85.340; FAN85.360; FAN85.380; FAN85.410; FAN85.430; FAN85.460; FAN85.480; FAN85.510; FAQ85.360; FAQ85.410; FAQ85.460; FAQ85.510; FAR85.340; FAR85.360; FAR85.380; FAR85.410; FAR85.430; FAR85.460; FAR85.480; FAR85.510; FAS85.340; FAS85.360; FAS85.380; FAS85.410; FAS85.430; FAS85.460; FAS85.480; FAS85.510) (4x2 & 6x2 & 6x2/4 & 6x4 & 8x2/4 & 8x2/6 & 8x2/4/6 & 8x4 & 8x4/4) 05.01-04.06

KNORR SB-SN7
22,5" AXIAL (0°) POTENTIO.
O/F

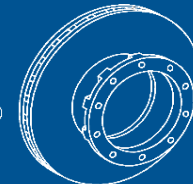
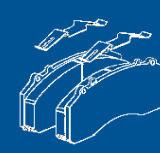
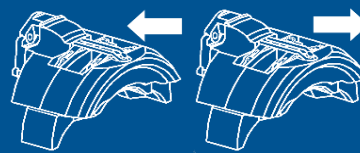
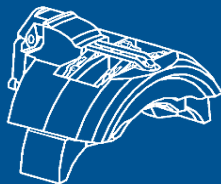
AV/F
AR/R

EFR7308 **EFR7309**

2920200764
2927802
2927804TU+
292530539

DF70004+
FCR225A
93145600

APPLICATION PAR VEHICULES APPLICATION BY VEHICLES



DAF (TRUCKS) ..!

CF85 (FAT85.340; FAT85.360; FAT85.380; FAT85.410; FAT85.430; FAT85.460; FAT85.480; FAT85.510; FAX85.340; FAX85.360; FAX85.380; FAX85.410; FAX85.430; FAX85.460; FAX85.480; FAX85.510; FT85.340; FT85.360; FT85.380; FT85.410; FT85.430; FT85.460; FT85.480; FT85.510; FTG85.340; FTG85.360; FTG85.380; FTG85.410; FTG85.430; FTG85.460; FTG85.480; FTG85.510; FTP85.340; FTP85.360; FTP85.380; FTP85.410; FTP85.430; FTP85.460; FTP85.480; FTP85.510; FTR85.360; FTR85.410; FTR85.460; FTR85.510; FTS85.340; FTS85.360; FTS85.380; FTS85.410; FTS85.430; FTS85.460; FTS85.480; FTS85.510; FTT85.340; FTT85.360; FTT85.380; FTT85.410; FTT85.430; FTT85.460; FTT85.480; FTT85.510) (4x2 & 6x2 & 6x2/4 & 6x4 & 8x2/4 & 8x2/6 & 8x2/4/6 & 8x4 & 8x4/4) 05.01-04.06

AV/F
KNORR SB-SN7
22,5" AXIAL (0°) POTENTIO.
O/F

EFR7308

EFR7309

AR/R

TM
2920200764
2927802
2927804TU+
292530539

DF70004+
FCR225A
93145600

CF85 (FA85.340; FA85.360; FA85.380; FA85.410; FA85.430; FA85.460; FA85.480; FA85.510; FAC85.340; FAC85.360; FAC85.380; FAC85.410; FAC85.430; FAC85.460; FAC85.480; FAC85.510; FAD85.340; FAD85.360; FAD85.380; FAD85.410; FAD85.430; FAD85.460; FAD85.480; FAD85.510; FAG85.340; FAG85.360; FAG85.380; FAG85.410; FAG85.430; FAG85.460; FAG85.480; FAG85.510; FAN85.340; FAN85.360; FAN85.380; FAN85.410; FAN85.430; FAN85.460; FAN85.480; FAN85.510; FAQ85.360; FAQ85.410; FAQ85.460; FAQ85.510; FAR85.340; FAR85.360; FAR85.380; FAR85.410; FAR85.430; FAR85.460; FAR85.480; FAR85.510; FAS85.340; FAS85.360; FAS85.380; FAS85.410; FAS85.430; FAS85.460; FAS85.480; FAS85.510) (4x2 & 6x2 & 6x2/4 & 6x4 & 8x2/4 & 8x2/6 & 8x2/4/6 & 8x4 & 8x4/4) 05.06-

AV/F
KNORR SB-SN7
22,5" AXIAL (0°) POTENTIO.
O/F CLIP

EFR7328

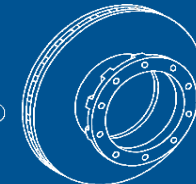
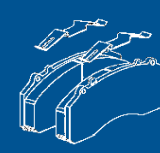
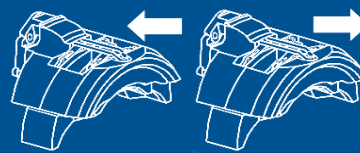
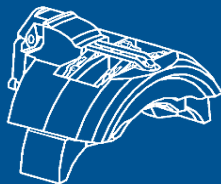
EFR7329

AR/R

2920200764
2927802
2927804TU+
292530539

DF70004+
FCR225A
93145600

APPLICATION PAR VEHICULES APPLICATION BY VEHICLES



DAF (TRUCKS) ..!..

CF85 (FAT85.340; FAT85.360; FAT85.380; FAT85.410; FAT85.430; FAT85.460; FAT85.480; FAT85.510; FAX85.340; FAX85.360; FAX85.380; FAX85.410; FAX85.430; FAX85.460; FAX85.480; FAX85.510; FT85.340; FT85.360; FT85.380; FT85.410; FT85.430; FT85.460; FT85.480; FT85.510; FTG85.340; FTG85.360; FTG85.380; FTG85.410; FTG85.430; FTG85.460; FTG85.480; FTG85.510; FTP85.340; FTP85.360; FTP85.380; FTP85.410; FTP85.430; FTP85.460; FTP85.480; FTP85.510; FTR85.360; FTR85.410; FTR85.460; FTR85.510; FTS85.340; FTS85.360; FTS85.380; FTS85.410; FTS85.430; FTS85.460; FTS85.480; FTS85.510; FTT85.340; FTT85.360; FTT85.380; FTT85.410; FTT85.430; FTT85.460; FTT85.480; FTT85.510) (4x2 & 6x2 & 6x2/4 & 6x4 & 8x2/4 & 8x2/6 & 8x2/4/6 & 8x4 & 8x4/4) 05.06-

AV/F
KNORR SB-SN7
22,5" AXIAL (0°) POTENTIO.
O/F CLIP

EFR7328

EFR7329

TM
2920200764
2927802
2927804TU+
292530539

DF70004+
FCR225A
93145600

CF (FA290; FA330; FA370; FA400; FA410; FA440; FA460; FA510; FAD400; FAD410; FAD440; FAD460; FAD510; FAG290; FAG330; FAG370; FAG400; FAG410; FAG440; FAG460; FAG510; FAN290; FAN330; FAN370; FAN400; FAN410; FAN440; FAN460; FAN510; FAR290; FAR330; FAR370; FAR400; FAR410; FAR440; FAR460; FAR510; FAS290; FAS330; FAS370; FAS400; FAS410; FAS440; FAS460; FAS510; FAT290; FAT330; FAT370; FAT400; FAT410; FAT440; FAT460; FAT510; FT290; FT330; FT370; FT400; FT410; FT440; FT460; FT510; FTG400; FTG410; FTG440; FTG460; FTG510; FTP400; FTP410; FTP440; FTP460; FTP510; FTR410; FTR460; FTR510; FTS410; FTS460; FTS510; FTT400; FTT410; FTT440; FTT460; FTT510) (4x2 & 6x2 & 6x2/4 & 6x4 & 8x4/4) 05.13-

AV/F
KNORR SB-SN7
22,5" AXIAL (0°) POTENTIO.
O/F CLIP

EFR7328

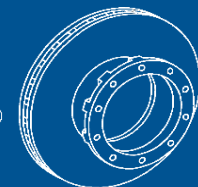
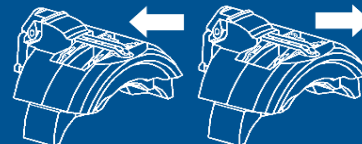
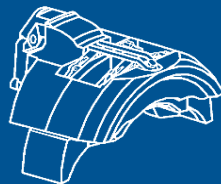
EFR7329

2920200764
2927802
2927804TU+
292530539

DF70004+
FCR225A
93145600

AR/R

APPLICATION PAR VEHICULES APPLICATION BY VEHICLES



DAF (TRUCKS) ..!

XF95 (FA95.380; FA95.430; FA95.480; FA95.530; FAD95.380; FAD95.430; FAD95.480; FAD95.530; FAK95.380; FAK95.430; FAK95.480; FAK95.530; FAN95.380; FAN95.430; FAN95.480; FAN95.530; FAR95.380; FAR95.430; FAR95.480; FAR95.530; FAS95.380; FAS95.430; FAS95.480; FAS95.530; FAT95.380; FAT95.430; FAT95.480; FAT95.530; FT95.380; FT95.430; FT95.480; FT95.530; FTG95.380; FTG95.430; FTG95.480; FTG95.530; FTM95.380; FTM95.430; FTM95.480; FTM95.530; FTP95.380; FTP95.430; FTP95.480; FTP95.530; FTR95.380; FTR95.430; FTR95.480; FTR95.530; FTS95.380; FTS95.430; FTS95.480; FTS95.530; FTT95.380; FTT95.430; FTT95.480; FTT95.530) (4x2 & 6x2 & 6x2/4 & 6x4 & 8x2/4 & 8x4/4) 05.01-04.06

AV/F
KNORR SB-SN7
22,5" AXIAL (0°) POTENTIO.
O/F

EFR7308

EFR7309

TM
2920200764
2927802
2927804TU+
292530539

DF70004+
FCR225A
93145600

AR/R

XF95 (FA95.380; FA95.430; FA95.480; FA95.530; FAD95.380; FAD95.430; FAD95.480; FAD95.530; FAK95.380; FAK95.430; FAK95.480; FAK95.530; FAN95.380; FAN95.430; FAN95.480; FAN95.530; FAR95.380; FAR95.430; FAR95.480; FAR95.530; FAS95.380; FAS95.430; FAS95.480; FAS95.530; FAT95.380; FAT95.430; FAT95.480; FAT95.530; FT95.380; FT95.430; FT95.480; FT95.530; FTG95.380; FTG95.430; FTG95.480; FTG95.530; FTM95.380; FTM95.430; FTM95.480; FTM95.530; FTP95.380; FTP95.430; FTP95.480; FTP95.530; FTR95.380; FTR95.430; FTR95.480; FTR95.530; FTS95.380; FTS95.430; FTS95.480; FTS95.530; FTT95.380; FTT95.430; FTT95.480; FTT95.530) (4x2 & 6x2 & 6x2/4 & 6x4 & 8x2/4 & 8x4/4) 05.06-09.12

AV/F
KNORR SB-SN7
22,5" AXIAL (0°) POTENTIO.
O/F CLIP

EFR7328

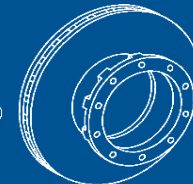
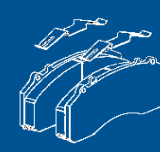
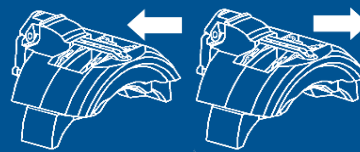
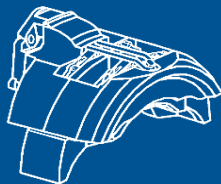
EFR7329

2920200764
2927802
2927804TU+
292530539

DF70004+
FCR225A
93145600

AR/R

APPLICATION PAR VEHICULES APPLICATION BY VEHICLES



DAF (TRUCKS) ..!..

XF105 (FA105.410; FA105.460; FA105.510;
FAD105.410; FAD105.460; FAD105.510; FAK105.410;
FAK105.460; FAK105.510; FAN105.410; FAN105.460;
FAN105.510; FAR105.410; FAR105.460; FAR105.510;
FAS105.410; FAS105.460; FAS105.510; FAT105.410;
FAT105.460; FAT105.510; FT105.410; FT105.460;
FT105.510; FTG105.410; FTG105.460; FTG105.510;
FTM105.410; FTM105.460; FTM105.510; FTP105.410;
FTP105.460; FTP105.510; FTR105.410; FTR105.460;
FTR105.510; FTS105.410; FTS105.460; FTS105.510;
FTT105.410; FTT105.460; FTT105.510) (4x2 & 6x2 &
6x2/4 & 6x2/2/4 & 6x4 & 8x2/4 & 8x4/4) 05.01-04.06

AV/F
KNORR SB-SN7
22,5" AXIAL (0°) POTENTIO.
O/F

EFR7308

EFR7309

TM

2920200764
2927802
2927804TU+
292530539

DF70004+
FCR225A
93145600

XF105 (FA105.410; FA105.460; FA105.510;
FAD105.410; FAD105.460; FAD105.510; FAK105.410;
FAK105.460; FAK105.510; FAN105.410; FAN105.460;
FAN105.510; FAR105.410; FAR105.460; FAR105.510;
FAS105.410; FAS105.460; FAS105.510; FAT105.410;
FAT105.460; FAT105.510; FT105.410; FT105.460;
FT105.510; FTG105.410; FTG105.460; FTG105.510;
FTM105.410; FTM105.460; FTM105.510; FTP105.410;
FTP105.460; FTP105.510; FTR105.410; FTR105.460;
FTR105.510; FTS105.410; FTS105.460; FTS105.510;
FTT105.410; FTT105.460; FTT105.510) (4x2 & 6x2 &
& 6x2/4 & 6x2/2/4 & 6x4 & 8x2/4 & 8x4/4) 05.06-09.12

AV/F
KNORR SB-SN7
22,5" AXIAL (0°) POTENTIO.
O/F CLIP

EFR7328

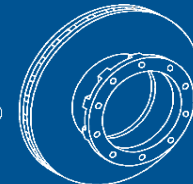
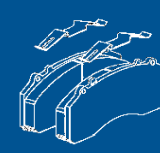
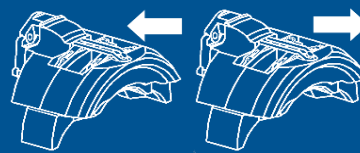
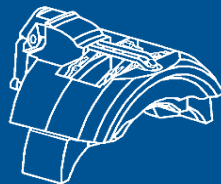
EFR7329

2920200764
2927802
2927804TU+
292530539

DF70004+
FCR225A
93145600

AR/R

**APPLICATION PAR VEHICULES
APPLICATION BY VEHICLES**



DAF (TRUCKS) ..!

XF (FA410; FA440; FA460; FA510; FAD460; FAD510; FAN410; FAN440; FAN460; FAN510; FAR410; FAR440; FAR460; FAR510; FAS410; FAS440; FAS460; FAS510; FT410; FT440; FT460; FT510; FTG410; FTG440; FTG460; FTG510; FTP410; FTP440; FTP460; FTP510; FTT460; FTT510) (4x2 & 6x2 & 6x2/4 & 6x4 & 8x4/4) 10.12-

KNORR SB-SN7
22,5" AXIAL (0°) POTENTIO.
O/F CLIP

AV/F

AR/R

EFR7328

EFR7329

2920200764
2927802
2927804TU+
292530539

DF70004+
FCR225A
93145600

DENNIS

ELITE 2 (240; 240ML; 240MS; 240RS; 250; 250ML; 260; 260ML; 260MS; 260RS; 275; 275ML; 275MS; 275RS; 290; 290ML; 290MS; 290RS; 300; 300AR; 300ML; 300MS; 300RS; 320) (4x2 & 6x2 & 6x2/4 & 6x2/2/4 & 6x4) 05.03-

22,5" MERITOR D LISA

AV/F

AR/R

EFR7614

EFR7615

2909009
CVP023K

ENVIRO (200; 300) (4x2) 01.03-

19,5" WABCO PAN 19-1
Plus

AV/F

AR/R

EFR60xx

EFR60xx

2931301

ENVIRO (400; 500) (6x2) 01.02-

22,5" KNORR SB-SN7
AXIAL (0°)
KNORR SB7 RADIAL
(93°+)

AV/F

AR/R

EFR7302

EFR7303

2920200764
2927802
292530539

ENVIRO (R340; R345; R420) 01.02-

19,5" WABCO PAN 19-1
Plus

AV/F

AR/R

EFR60xx

EFR60xx

2931301

SERIE R (4x2) 01.96-

22,5" KNORR SB-SN7
AXIAL (0°)

AV/F

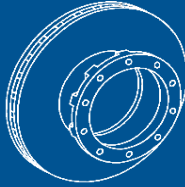
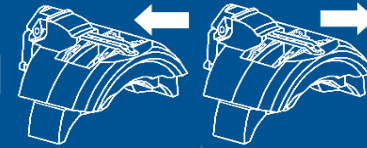
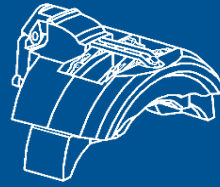
AV/F

EFR7303

EFR7302

2920200764
2927802

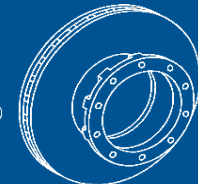
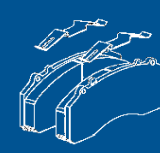
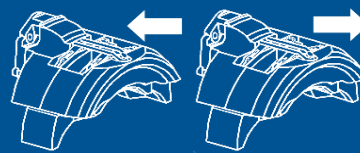
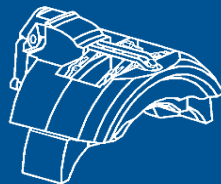
APPLICATION PAR VEHICULES
APPLICATION BY VEHICLES



EVO BUS (CARS ET BUS)

CITARO O530 (6X2) 01.98-	22,5"	KNORR SB-SN7 AXIAL (-12°) POTENTIO. CONTINU	AV/F	EFR7304	EFR7305	2920200764 2927802 292530539	DF70000 09.B325.30 FCR145A 93087900
		KNORR SB7 RADIAL (93°+) POTENTIO. CONTINU VIS	AR/R2 AR/R	EFR7317	EFR7316	2920200764 2927802 292530539	DF70000 09.B325.30 FCR145A 93087900
CITARO O530 (8X4) 01.98-	22,5"	KNORR SB-SN7 AXIAL (-12°) POTENTIO. CONTINU	AR/R	EFR7304	EFR7305	2920200764 2927802 292530539	DF70000 09.B325.30 FCR145A 93087900
CITO O 520 06.99-	22,5"	KNORR SB-SN7 AXIAL (-12°) POTENTIO. CONTINU	AV/F	EFR7304	EFR7305	2920200764 2927802 292530539	DF70000 09.B325.30 FCR145A 93087900
		KNORR SB-SN7 AXIAL (0°) POTENTIO. CONTINU VIS	AR/R	EFR7310	EFR7311	2920200764 2927802 292530539	DF70000 09.B325.30 FCR145A 93087900

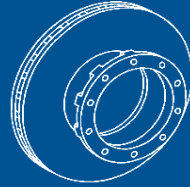
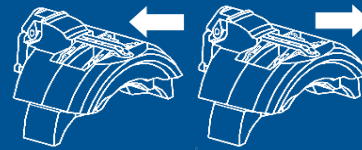
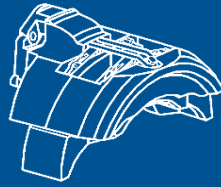
APPLICATION PAR VEHICULES APPLICATION BY VEHICLES



EVO BUS (CARS ET BUS)../..

CITYBUS A20 01.99-	22,5"	KNORR SB-SN7 AXIAL (0°) POTENTIO. CONTINU VIS	AV/F	EFR7311	EFR7310	2920200764 2927802 292530539	
		KNORR SB7 RADIAL (93°+)	AR/R2 AR/R	EFR7315	EFR7314	2920200764 2927802 292530539	
INTEGRO O 550 (12M) (INTEGRO L; INTEGRO M) 01.00-12.05	22,5"	MERITOR D3	AV/F AR/R	EFR7606	EFR7607	2903009 CVP013K	
INTEGRO O 550 (12M) (INTEGRO L; INTEGRO M) 01.06-	22,5"	KNORR SB-SN7	AV/F	EFR73XX	EFR73XX	2920200764 2927802 292530539	DF70000 09.B325.30 FCR145A 93087900
			AR/R	EFR73XX	EFR73XX		DF70008 09.A741.10 FCR323A 93186700
S3 01.96-06.96	22,5"	KNORR SB-SN7 AXIAL (0°) POTENTIO. CONTINU VIS	AV/F	EFR7311	EFR7310	2920200764 2927802 292530539	DF70000 09.B325.30 FCR145A 93087900
		KNORR SB7 RADIAL (86°+)	AR/R2 AR/R	EFR7307	EFR7306	2920200764 2927802 292530539	

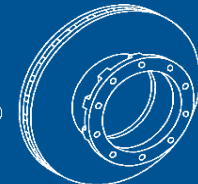
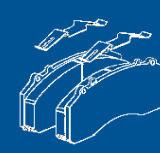
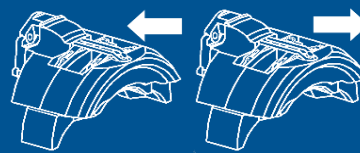
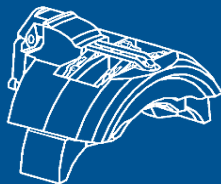
APPLICATION PAR VEHICULES
APPLICATION BY VEHICLES



EVO BUS (CARS ET BUS)../..

S3 07.96-01.99	22,5"	KNORR SB-SN7 AXIAL (0°) POTENTIO. CONTINU VIS	AV/F	EFR7311	EFR7310	2920200764 2927802 292530539	
		KNORR SB7 RADIAL (93°+)	AR/R2 AR/R	EFR7315	EFR7314	2920200764 2927802 292530539	
S316HDS 01.95-	22,5"	KNORR SB-SN7 AXIAL (-12°)	AV/F	EFR7300	EFR7301	2920200764 2927802 292530539	
S328DT 01.95-	22,5"	KNORR SB-SN7 AXIAL (-12°)	AV/F	EFR7300	EFR7301	2920200764 2927802 292530539	
TRAVEGO O 580 06.99-	22,5"	KNORR SB-SN7 AXIAL (-12°) POTENTIO. CONTINU	AV/F	EFR7304	EFR7305	2920200764 2927802 292530539	DF70000 09.B325.30 FCR145A 93087900
		KNORR SB-SN7 AXIAL (12°+) POTENTIO. CONTINU	AR/R2	EFR7312	EFR7313	2920200764 2927802 292530539	DF70000 09.B325.30 FCR145A 93087900
		KNORR SB-SN7 AXIAL (0°) POTENTIO. CONTINU VIS	AR/R	EFR7310	EFR7311	2920200764 2927802 292530539	DF70000 09.B325.30 FCR145A 93087900

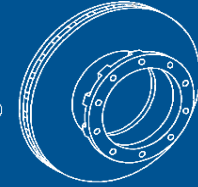
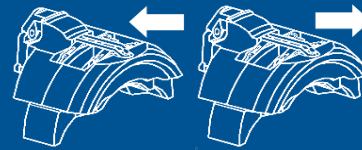
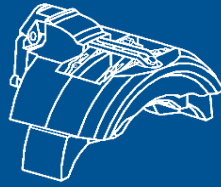
APPLICATION PAR VEHICULES
APPLICATION BY VEHICLES



EVO BUS (CARS ET BUS)...

SETRA (312; 315 UL) 01.01-	22,5" KNORR SB-SN7 AXIAL (12°+) POTENTIO. CONTINU	AV/F	EFR7312	EFR7313	2920200764 2927802 292530539	
SETRA (312; 315 UL) 01.01-	22,5" MERITOR D3	AV/F	EFR7606	EFR7607	2903009 CVP013K	
SETRA (COMFORT CLASS; TOP CLASS) 01.99-	22,5" KNORR SB-SN7 AXIAL (-12°) POTENTIO. CONTINU	AV/F AR/R2	EFR7304	EFR7305	2920200764 2927802 292530539	
	22,5" KNORR SB-SN7 AXIAL (0°) POTENTIO. CONTINU VIS	AR/R	EFR7311	EFR7310		
SETRA (S210; S210HD; S210HDV; S211; S212 HUE; S213; S214; S215; S215 HDH; S215UL; S215SL; S216HDS; S216HDS; S216 HDS; S228DT) 01.89-	22,5" KNORR K85	AV/F	EFRXXX	EFRXXX	2974703	
SETRA (S211; S215; S216) 01.92-	22,5" MERITOR D3	AV/F	EFR7606	EFR7607	2903009 CVP013K	09.8129.20 FCR114A 93058100
SETRA (S300NC; S315H; S315HDH) 01.92-	22,5" MERITOR D3	AV/F	EFR7606	EFR7607	2903009 CVP013K	09.8129.20 FCR114A 93058100
SETRA (S315GT; S315GTHD) 01.99-	22,5" MERITOR D3	AV/F	EFR7606	EFR7607	2903009 CVP013K	09.8129.20 FCR114A 93058100

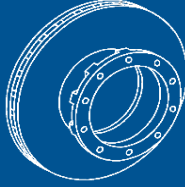
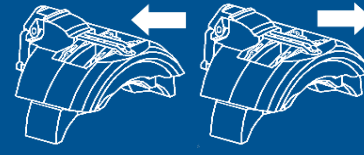
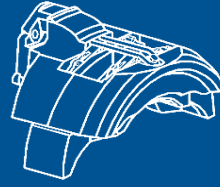
**APPLICATION PAR VEHICULES
APPLICATION BY VEHICLES**



EVO BUS (CARS ET BUS)../..

SETRA (S315NF) 01.99-	22,5"	MERITOR D3	AV/F	EFR7606	EFR7607	2903009 CVP013K	09.8129.20 FCR114A 93058100
SETRA (S315NF) 01.02-	22,5"	KNORR SB-SN7 AXIAL (0°)	AV/F	EFR7302	EFR7303	2920200764 2927802	09.B325.40 FCR168A 93086800
		KNORR SB7 RADIAL (93°+) POTENTIO. CONTINU VIS	AR/R	EFR7317	EFR7316	292530539	
SETRA (S412UL; S415UL; S416GTHD) 01.01-	22,5"	KNORR SB-SN7 AXIAL (-12°) POTENTIO. CONTINU	AV/F	EFR7304	EFR7305	2920200764 2927802	09.B325.40 FCR168A 93086800
		KNORR SB-SN7 AXIAL (12°+) POTENTIO. CONTINU	AR/R	EFR7312	EFR7313	292530539	
SETRA (S415NF; S416NF Essieu ZF) 01.06-	22,5"	KNORR SB-SN7 AXIAL (-12°) POTENTIO. CONTINU	AV/F	EFR7304	EFR7305	2920200764 2927802	09.B325.40 FCR168A 93086800
		KNORR SB7 RADIAL (93°+) POTENTIO. CONTINU VIS	AR/R	EFR7317	EFR7316	292530539	
SETRA (S416; S417; S419; S431) (3 Essieux) 01.01-	22,5"	KNORR SB-SN7 AXIAL (- 12°) POTENTIO. CONTINU	AV/F	EFR7304	EFR7305	2920200764 2927802	09.B325.40 FCR168A 93086800
		KNORR SB-SN7 AXIAL (12°+) POTENTIO. CONTINU	AR/R	EFR7312	EFR7313	292530539	
		KNORR SB-SN7 AXIAL (- 12°) POTENTIO. CONTINU	AR/R2	EFR7304	EFR7305		

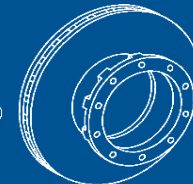
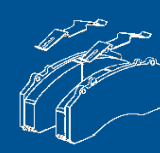
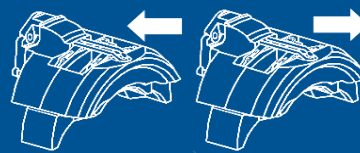
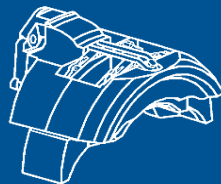
**APPLICATION PAR VEHICULES
APPLICATION BY VEHICLES**



FAST

SCOLER 2 01.96-12.00	22,5"	MERITOR D LISA	AV/F	EFR7610	EFR7611	2909006 CVP023K
SCOLER 2 01.01-	22,5"	MERITOR D LISA	AV/F	EFR7610	EFR7611	2909006 CVP023K
		MERITOR D ELSA 2	AR/R	EFR7684	EFR7685	2913105 CVP088K
SCOLER 3 03.04-	22,5"	MERITOR ELSA 1	AV/F	EFR7646	EFR7647	2911303
SCOLER 3 (Chassis MAN A91 - BRAKE KNORR) 03.04-	22,5"	KNORR SB-SN7	AV/F			2920200764
		AXIAL (0°) POTENTIO. CONTINU VIS	AR/R	EFR7344	EFR7345	2927802 292530539
SCOLER 3 (Chassis MAN A91 - BRAKE MERITOR) 03.04-	22,5"	MERITOR ELSA 2	AV/F	EFR7702	EFR7703	2913105
		MERITOR ELSA 2	AR/R	EFR7698	EFR7699	CVP088K
SCOLER 4 (Chassis RENAULT) 01.06-	22,5"	MERITOR ELSA 225-1	AV/F	EFR7680	EFR7681	2917300604
		AXIAL		EFR7680R	EFR7681R	2917301 2927201
STARTER (Chassis MAN A91 - BRAKE MERITOR) 03.04-	22,5"	MERITOR ELSA 2	AV/F	EFR7702	EFR7703	2913105
			AR/R	EFR7698	EFR7699	CVP088K
SYTER 01.99-	22,5"	MERITOR ELSA 1	AV/F	EFR7642	EFR7643	2911303
			AR/R	EFR7636	EFR7637	2911303
SYTER (Chassis MAN A51 - BRAKE KNORR) 01.99-	22,5"	KNORR SB-SN7 AXIAL (0°)	AV/F			2920200764
			AR/R	EFR7303	EFR7302	2927802 292530539
SYTER (Chassis MAN A51 - BRAKE MERITOR) 01.99-	22,5"	MERITOR ELSA 1	AV/F	EFR7646	EFR7647	2911303
			AR/R	EFR7636	EFR7637	2911303

**APPLICATION PAR VEHICULES
APPLICATION BY VEHICLES**



FRUEHAUF

BRAKE HALDEX (Carrier 6 Trous/Holes)	22,5"	HALDEX MODULX DB 22		EFR7202	EFR7202	2914302	
BRAKE HALDEX (Carrier 4 Trous/Holes)	22,5"	HALDEX MODULX DB 22		EFR7203	EFR7203	2914302	
BRAKE KNORR WH. 19.5"	19,5"	KNORR SB-SN6 AXIAL (5°+)		EFR6300	EFR6301	2932004 CVP036K	09.8543.10 FCR200A 93193600
BRAKE KNORR WH. 22.5" 02.98-	22,5"	KNORR SB-SN7 AXIAL (0°)		EFR7302	EFR7303	2920200764 2927801 292530539	09.8526.10 FCR199A 93102000
BRAKE WABCO WH. 22.5" 01.00-	22,5"	WABCO PAN 22-2		EFR7000	EFR7001	29154xx	09.8526.10 FCR199A 93102000

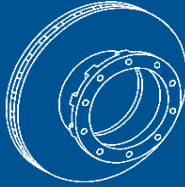
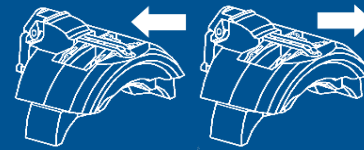
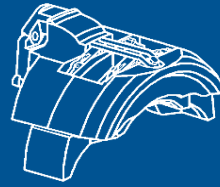
GEPEBUS

OREOS 4X	19,5"	KNORR SB-SN6 AXIAL (5°+)	AV/F AR/R	EFR6300	EFR6301	2932002 CVP036K	
OREOS 55	19,5"	MERITOR C LISA	AV/F	EFR6654	EFR6655	2910004	

GIGANT SAE (AXLE)

BRAKE KNORR WH. 17.5"	17,5"	KNORR SB-SN5 POTENTIO. O/F		EFR5302	EFR5303	2918302	FCR295A
BRAKE HALDEX WH. 19.5"	19,5"	HALDEX DB 19		EFR6201	EFR6201	29181006042 918101	
BRAKE KNORR WH. 19.5" 01.98-	19,5"	KNORR SB-SN6 AXIAL (5°+)		EFR6300	EFR6301	2932004 CVP036K	
BRAKE WABCO WH. 19.5" 01.98-	19,5"	WABCO PAN 19-1 Plus		EFR6006	EFR6007	2931302	W0760SA

**APPLICATION PAR VEHICULES
APPLICATION BY VEHICLES**



GIGANT SAE (AXLE)/

BRAKE HALDEX WH. 22.5"	22,5" HALDEX DB 22		EFR7208	EFR7208	2914302	
BRAKE HALDEX WH. 22.5" 01.06-	22,5" HALDEX DB 22 LT		EFR7204	EFR7204	29175 FCV4420B	
BRAKE PROTEC KNORR WH. 22.5" 01.98-	22,5" KNORR SB-SN7 AXIAL (-12°)		EFR7300	EFR7301	2920200764 2927801 292530539	FCR294A 93193200
BRAKE WABCO WH. 22.5" 01.00-	22,5" WABCO PAN 22-1		EFR7002	EFR7003	2933601	

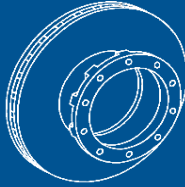
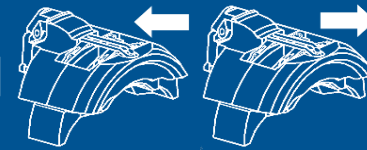
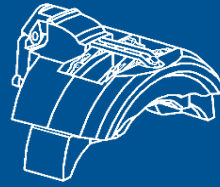
HENDRICKSON

BRAKE KNORR WH. 19.5"	19,5" KNORR SB-SN6 AXIAL (5°+) POTENTIO. CONTINU		EFR6307	EFR6306	2932004 CVP036K	
BRAKE KNORR WH. 19.5"	19,5" KNORR SB-SN6 AXIAL (5°+) POTENTIO. CONTINU CLIP		EFR6317	EFR6316	2932004 CVP036K	
BRAKE KNORR WH. 19.5"	19,5" KNORR SB-SN6 AXIAL (5°+) POTENTIO. O/F		EFR6304	EFR6305	2932004 CVP036K	
BRAKE KNORR WH. 22.5"	22,5" KNORR SB-SN7 AXIAL (0°)		EFR7302	EFR7303	2920200764 2927801 292530539	

HEULIEZ

GX117 01.98-	22,5" MERITOR D LISA	AV/F	EFR7610	EFR7611	2909006 CVP023K	
	MERITOR ELSA 1	AR/R	EFR7638	EFR7639	2903007 CVP013K	

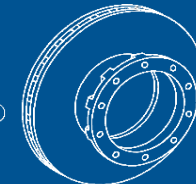
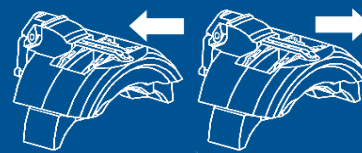
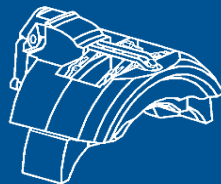
APPLICATION PAR VEHICULES
APPLICATION BY VEHICLES



HEULIEZ ..!..

GX127 01.05-	22,5"	MERITOR D LISA	AV/F	EFR7610	EFR7611	2909006 CVP023K	
		MERITOR D ELSA 2	AR/R	EFR7684	EFR7685	2913105 CVP088K	
GX137 01.14-	22,5"	KNORR SB-SN7 AXIAL (-12°)	AV/F	EFR7300	EFR7301	2920200764 2927802	
		KNORR SB7 RADIAL (93°+)	AR/R	EFR7315	EFR7314	292530539	
GX217 01.96-	22,5"	MERITOR D LISA	AV/F	EFR7612	EFR7613	2909009 CVP023K	09.7870.10 FCR134A 93086100
GX317 01.94-	22,5"	MERITOR D3	AV/F	EFR7602	EFR7603	2903007 CVP013K	09.7870.10 FCR134A 93086100
GX327 01.05-	22,5"	MERITOR D LISA	AV/F	EFR7610	EFR7611	2909006 CVP023K	
		MERITOR D ELSA 2	AR/R	EFR7684	EFR7685	2913105 CVP088K	
GX337 01.14-	22,5"	KNORR SB-SN7 AXIAL (-12°)	AV/F	EFR7300	EFR7301	2920200764 2927802	
		KNORR SB7 RADIAL (93°+)	AR/R	EFR7315	EFR7314	292530539	
GX417 01.96-	22,5"	MERITOR D LISA	AV/F	EFR7612	EFR7613	2909009 CVP023K	09.7870.10 FCR134A 93086100
GX427 01.07-	22,5"	MERITOR ELSA 225-3 AXIAL	AV/F	EFR7686	EFR7687	2917400604 2917401 2927301	
		MERITOR D ELSA 2	AR/R	EFR7684	EFR7685	2913105 CVP088K	

APPLICATION PAR VEHICULES
APPLICATION BY VEHICLES



HEULIEZ/.

GX437 01.14-

22,5"	KNORR SB-SN7 AXIAL (-12°)	AV/F	EFR7300	EFR7301	2920200764
	KNORR SB7 RADIAL (93°+)	AR/R	EFR7315	EFR7314	2927802 292530539

KOGEL

TRAXX (ABS+) 01.05-

22,5"	MERITOR ELSA 225L- 2 AXIAL		EFR7704	EFR7705	2921101	09.8579.10 FCR250A 93192700 ou/or DF713889
-------	-------------------------------	--	---------	---------	---------	--

IRISBUS (CARS ET BUS) IVECO

370S (12/24/25/27/30/35) 01.83-

22,5"	BREMBO HD22.130	AV/F	520.5310.10	520.5310.20	2907503
-------	-----------------	------	-------------	-------------	---------

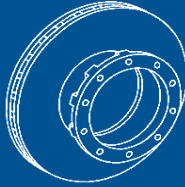
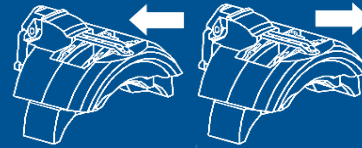
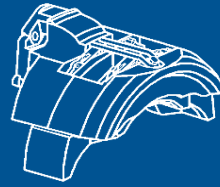
ACCESS BUS (GX127; GX127L) (4x2) 03.06-

22,5"	MERITOR D LISA	AV/F	EFR7610	EFR7611	2909006 CVP023K
	MERITOR D ELSA 2	AR/R	EFR7684	EFR7685	2913105 CVP088K

AGORA (L;S) (4x2 & 6x2) 11.97-12.02

22,5"	MERITOR D LISA	AV/F	EFR7610	EFR7611	2909006 CVP023K	W0250RT 98025200	09.7870.10 FCR134A 93086100
	MERITOR ELSA 1	AR/R	EFR7638	EFR7639	2903007 CVP013K		

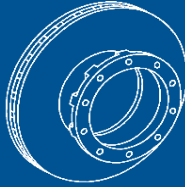
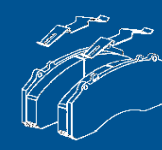
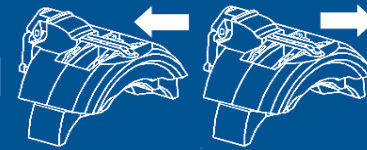
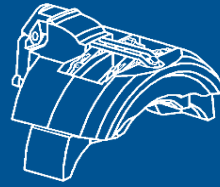
APPLICATION PAR VEHICULES
APPLICATION BY VEHICLES



IRISBUS (CARS ET BUS) IVECO/

AGORA (L;S) (4x2 & 6x2) 01.03-	22,5"	MERITOR D LISA	AV/F	EFR7610	EFR7611	2909006 CVP023K	W0250RT 98025200	09.7870.10 FCR134A 93086100
		MERITOR D ELSA 2	AR/R	EFR7684	EFR7685	2913105 CVP088K	W0250RT 98025200	09.7870.10 FCR134A 93086100
ARES 01.02-	22,5"	MERITOR D ELSA 2	AV/F	EFR7666	EFR7667	2913105 CVP088K	W0355RT1V1 98027600	
			AR/R	EFR7674	EFR7675			
ARWAY (10.6M; 12M;12.8M) (4x2) 06.06-	22,5"	MERITOR D ELSA 2	AV/F	EFR7664	EFR7665	2913105 CVP088K	W0355RT1V1 98027600	
			AR/R	EFR7674	EFR7675			
ARWAY (15M) (6x2) 06.06-	22,5"	MERITOR D ELSA 2	AV/F	EFR7664	EFR7665	2913105 CVP088K	W0360RT 98025500	
			AR/R	EFR7674	EFR7675			
AXER (12M; 12.8M) (4x2) 03.05-01.07	22,5"	MERITOR D ELSA 2	AV/F	EFR7664	EFR7665	2913105 CVP088K	W0355RT1V1 98027600	
			AR/R	EFR7674	EFR7675			
CITELIS 09.05-12.13	22,5"	MERITOR D LISA	AV/F	EFR7610	EFR7611	2909006 CVP023K	W0250RT 98025200	
		MERITOR D ELSA 2	AR/R	EFR7684	EFR7685	2913105 CVP088K	W0355RT1V1 98027600	
CITELIS 18 09.05-12.13	22,5"	MERITOR ELSA 225-3 AXIAL	AV/F	EFR7686	EFR7687	2917400604 2917401 2927301		
			AR/R	EFR7684	EFR7685	2913105 CVP088K		

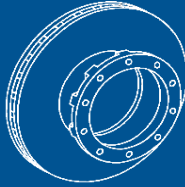
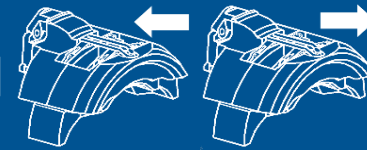
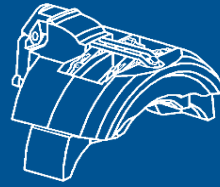
APPLICATION PAR VEHICULES
APPLICATION BY VEHICLES



IRISBUS (CARS ET BUS) IVECO/

CITY BUS 01.01-	22,5"	MERITOR DX 225 (17-18)	AV/F	EFR7712	EFR7713	2915001	09.7870.10 FCR134A 93086100
			AR/R				
CITY CLASS 01.98-	22,5"	MERITOR DX 225 (15-16)	AV/F	EFR7714	EFR7715	2915001	
		MERITOR DX 225 (21-22)	AR/R	EFR7670	EFR7671		
CREALIS (12; 12NEO; 12CNG; 12NEO CNG; 18; 18NEO; 18CNG; 18NEO CNG) (4x2 & 6x2) 04.98-12.06	22,5"	MERITOR D LISA	AV/F	EFR7610	EFR7611	2909006 CVP023K	W0250RT 98025200
		MERITOR D ELSA 2	AR/R	EFR7684	EFR7685	2913105 CVP088K	W0355RT1V1 98027600
CREALIS (12; 12NEO; 12CNG; 12NEO CNG; 18; 18NEO; 18CNG; 18NEO CNG) (4x2 & 6x2) 01.07-	22,5"	KNORR SB-SN7 AXIAL (-12°)	AV/F	EFR7300	EFR7301	2920200764 2927802	
		KNORR SB7 RADIAL (93°+)	AR/R	EFR7315	EFR7314	292530539	
CRONUS -10.98	22,5"	MERITOR ELSA 1	AV/F	EFR7638	EFR7639	2903007 CVP013K	W0360RT 98025500
			AR/R				
CROSSWAY (10.6M; 12M; 12.8M) (4x2) 06.06-	22,5"	MERITOR D ELSA 2	AV/F	EFR7664	EFR7665	2913105 CVP088K	W0360RT 98025500
			AR/R	EFR7674	EFR7675		
CROSSWAY LE 01.14-	22,5"	KNORR SB-SN7 AXIAL (-12°)	AV/F	EFR7300	EFR7301	2920200764 2927802	
			AR/R	EFR7301	EFR7300	292530539	09.B750.10
DOMINO (2001; HD; HDH) (4x2) 10.03-	22,5"	MERITOR D ELSA 2	AV/F	EFR7664	EFR7665	2913105 CVP088K	
			AR/R	EFR7674	EFR7675		

APPLICATION PAR VEHICULES
APPLICATION BY VEHICLES



IRISBUS (CARS ET BUS) IVECO/

EUROCLASS 01.84-

22,5" BREMBO HD22.106 AV/F **520.5360.12 520.5360.22 2918602**

BREMBO HD22.106 AV/F **520.5360.12 520.5360.22 2918602**

EURORIDER 01.92-

22,5" KNORR SB-SN7 AR/R **EFR7300 EFR7301 2920200764 2927802 292530539 09.9983.40 FCR173A 93096100**
AXIAL (-12°)

EUROSCOOL 01.05-

19,5" KNORR SB-SN6 AV/F **EFR6312 EFR6313 2932005 W0310IV34**
AXIAL (0°) AR/R **CVP036K 98025300**

EVADYS 10.03-

22,5" MERITOR D ELSA 2 AV/F **EFR7664 EFR7665 2913105 W0355RT1V1**
AR/R **EFR7674 EFR7675 CVP088K 98027600**

EVADYS (ZF AXLE) 10.03-

22,5" MERITOR D ELSA 2 AV/F **EFR7672 EFR7673 2913105 W0355RT1V1**
CVP088K 98027600

ILIADE (FRH; GT; GTC; GTE; GTX; GTXE; RTX; TX) (4x2) 01.97-05.00

22,5" MERITOR ELSA 1 AV/F **EFR7638 EFR7639 2903007 W0400RT 09.7870.10**
AR/R **CVP013K 98031900 FCR134A 93086100**

ILIADE 06.00-

22,5" MERITOR D ELSA 2 AV/F **EFR7664 EFR7665 2913105 W0355RT1V1 09.7870.10**
AR/R **EFR7674 EFR7675 CVP088K 98027600 FCR134A 93086100**

ILIADE (ZF AXLE) 10.03-

22,5" MERITOR D ELSA 2 AV/F **EFR7672 EFR7673 2913105 W0355RT1V1**
CVP088K 98027600

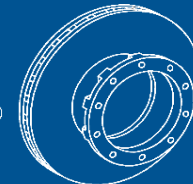
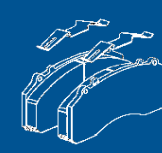
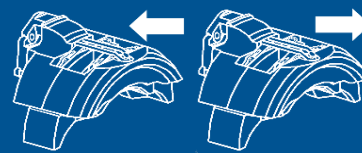
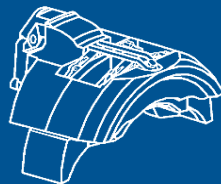
MAGELYS HD 08.08-12.13

22,5" MERITOR D ELSA 2 AV/F **EFR7664 EFR7665 2913105**
AR/R **CVP088K 09.B750.10**

PROWAY 01.09-

22,5" MERITOR D ELSA 2 AV/F **EFR7664 EFR7665 2913105 W0360RT**
AR/R **EFR7674 EFR7675 CVP088K 98025500**

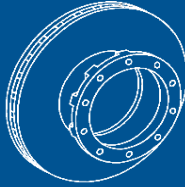
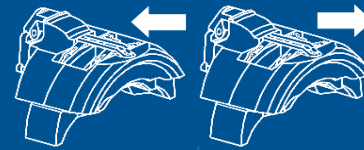
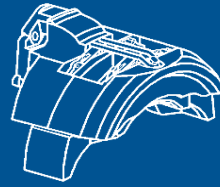
APPLICATION PAR VEHICULES
APPLICATION BY VEHICLES



IRISBUS (CARS ET BUS) IVECO/

R312 01.90-12.05	19,5" BREMBO HD19	AV/F	520.5320.12	520.5320.22	2907203		09.5319.10
		AR/R	520.5320.32	520.5320.42			
RECREO 10.03-01.07	22,5" MERITOR D ELSA 2	AV/F	EFR7664	EFR7665	2913105	W0355RT1V1	
		AR/R	EFR7674	EFR7675	CVP088K	98027600	
URBANWAY 01.14-	22,5" KNORR SB-SN7 AXIAL (-12°)	AV/F	EFR7300	EFR7301	2920200764		09.B750.10
	22,5" KNORR SB7 RADIAL (93°+)	AR/R	EFR7315	EFR7314	2927802		09.E161.10
					292530539		FCR353A
IRIZAR							
CENTURY INTERCENTURY; PB; S-KOOL (SCANIA K124) 01.97-05.01	22,5" KNORR SB-SN7 RADIAL (86°+) POTENTIO. CONTINU VIS	AV/F	EFR7324	EFR7325	2933100604		
	22,5" KNORR SB-SN7 AXIAL (0°) POTENTIO. CONTINU VIS	AR/R	EFR7310	EFR7311	2933102		
CENTURY (SCANIA K124) 05.01-	22,5" KNORR SB-SN7 AXIAL (R86°+) POTENTIO. CONTINU CLIP	AV/F	EFR7335	EFR7334	2920200764		
	22,5" KNORR SB7 RADIAL (93°+) POTENTIO. CONTINU CLIP	AR/R	EFR7322	EFR7323	2927802	292530539	01.09-12.15
					2933102		01.16-

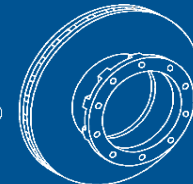
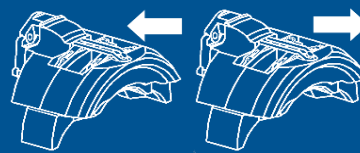
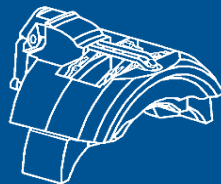
APPLICATION PAR VEHICULES
APPLICATION BY VEHICLES



IRIZAR ..!

NEW CENTURY 01.07-	22,5"	KNORR SB-SN7 AXIAL (R86°+) POTENTIO. CONTINU CLIP	AV/F	EFR7335	EFR7334	2920200764 2927802 292530539	W0310SV4 98025400		
		KNORR SB-SN7 AXIAL (0°) POTENTIO. CONTINU CLIP	AR/R	EFR7321	EFR7320	2933100604 2933102			
ISUZU									
HARMONY -12.04	17,5"	WABCO PAN 17	AV/F	EFR5002	EFR5003	2928504 CVP032K			
IVECO (TRUCKS)									
EUROCARGO (110EL) (DISC ABS+) 01.99-	17,5"	WABCO PAN 17	AV/F	EFR5002	EFR5003	2928503 CVP032K	W0365IV1 98031500	09.7804.60 FCR237A 93127400	
			AR/R						
EUROCARGO (120EL17; 120EL17P tector; 120E18; 120EL18 tector; 120EL21; 120EL21P tector; 120E22; 120EL22 tector) (4x2) (DISC ABS+) 01.99-	17,5"	WABCO PAN 17	AV/F	EFR5002	EFR5003	2928503 CVP032K	W0365IV1 98031500	09.7804.60 FCR237A 93127400	
			AR/R						
EUROCARGO (120E15; 120E15K; 120E18; 120E18H; 120E18K; 120E18P; 120E21H; 120E23; 120E23FP; 120E23H; 120E23P; 130E15; 130E15; 130E18; 130E18K; 130E23; 135E18W; 135E18WR; 135E21W; 135E23W; 135E23WR) (4x2 & 4x4) cou court 09.90-12.00	19,5"	BENDIX ADB 3700	AV/F	EFR6900	EFR6901	2903203	W0400IV 98022400 ou/or W0250IV 98022500	09.7315.20 FCR110A 93085000	

APPLICATION PAR VEHICULES APPLICATION BY VEHICLES



IVECO (TRUCKS)/

EUROCARGO (130E18 tector;130E18D tector;
130E18DK tector; 130E18DP tector; 130E18K tector;
130E21 tector; 130E21FP tector; 130E21K tector;
130E21P tector; 130E24 tector;130E24D tector;
130E24DK tector; 130E24DP tector130E24K tector;
130E25D tector; 130E25DK tector; 130E25DP tector;
130E28 tector; 130E28K tector) (4x2) 01.01-12.04
(ABS+)

19,5" KNORR SB-SN6
AXIAL (5°+)

AV/F

EFR6310

EFR6311

**2932005
CVP036K**

**W0310IV34
98025300**

**09.A563.40
FCR238A
93127500**

**09.7929.90
09.A563.90
FCR307A
93188600**

AR/R

EUROCARGO (130E18 tector;130E18D tector;
130E18DK tector; 130E18DP tector; 130E18K tector;
130E21 tector; 130E21FP tector; 130E21K tector;
130E21P tector; 130E24 tector;130E24D tector;
130E24DK tector; 130E24DP tector130E24K tector;
130E25D tector; 130E25DK tector; 130E25DP tector;
130E28 tector; 130E28K tector) (4x2) 01.05- **(ABS-)**

19,5" KNORR SB-SN6
AXIAL (0°)

AV/F

EFR6312

EFR6313

**2932005
CVP036K**

**W0310IV34
98025300**

**09.A562.10
FCR319A
93175200**

AR/R

EUROCARGO (140E18 tector; 140E18; 140E18DFP
tector;140E18DK tector; 140E18FP; 140E18K tector;
140E18K; 140E18P tector; 140E18P; 140E18W tector;
140E21 tector; 140E21FP; 140E21K; 140E21P; 140E22
tector; 140E22DFP tector; 140E22K tector; 140E22P
tector; 140E24 tector; 140E24FP tector; 140E24K tector;
140E24W tector; 140E24WS tector; 140E25DK tector;
140E25FP tector; 140E25K tector; 140E25P tector;
140E25W tector; 140E25WS tector; 140E28 tector;
140E28FP tector; 140E28K tector; 140E28P tector;
140E28W tector; 140E28WS tector; 140ED25 tector;
140E24P tector) (4x2 & 4x4) 01.08-09.15

19,5" KNORR SB-SN6
AXIAL (0°)

AV/F

EFR6312

EFR6313

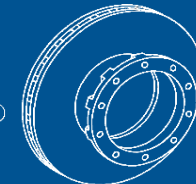
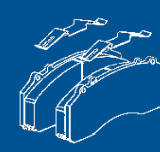
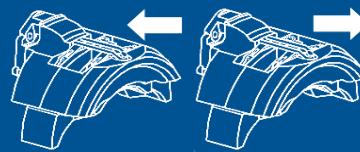
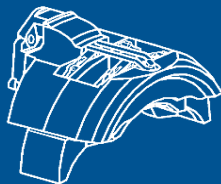
**2932005
CVP036K**

**W0310IV34
98025300**

**09.A563.30
FCR239A
93127600**

AR/R

APPLICATION PAR VEHICULES APPLICATION BY VEHICLES



IVECO (TRUCKS) ..!..

EUROCARGO (150E15; 150E15K; 150E18; 150E18K; 150E18P; 150E23; 150E23FP; 150E23P; 150E27; 150E27FP; 150E27P; 150E27R; 260E23; 280E23; 280E23P; 280E23T; 320E27; 320E27P; 320E27T) (4x2 & 6x2) cou long 01.91-12.00

19,5" BENDIX ADB 3700

AV/F

EFR6902

EFR6903

2903203

TM

W0400IV
98022400
ou/or
W0250IV
98022500

09.7316.20
FCR111A
93085100

EUROCARGO (150E18 tector; 150E18 tector; 150E18FP tector; 150E18K tector; 150E18P tector; 150E21 tector; 150E21FP tector; 150E21K tector; 150E21P tector; 150E22 tector; 150E22FP tector; 150E22K tector; 150E22P tector; 150E24 tector; 150E24K tector; 150E25 tector; 150E25K tector; 150E25W tector; 150E25WS tector; 150E28 tector; 150E28K tector; 150E28W tector; 150E28WS tector; 150E30 tector; 150E30FP tector; 150E30K tector; 150E30P tector; 160E21 tector; 160E21P tector; 160E22 tector; 160E22K tector; 160E22P tector; 160E24 tector; 160E24P tector; 160E25 tector; 160E25K tector; 160E25P tector; 160E28 tector; 160E28K tector; 160E28P tector; 160E30 tector; 160E30K tector; 160E30P tector) (4x2 & 4x4) (ABS+) 01.01-12.04

19,5" KNORR SB-SN6
AXIAL (5°+)

AV/F

EFR6310

EFR6311

2932005
CVP036K

W0310IV34
98025300

09.A563.30
FCR239A
93127600

AR/R

09.A563.80
FCR308A
93309200

EUROCARGO (150E18 tector; 150E18 tector; 150E18FP tector; 150E18K tector; 150E18P tector; 150E21 tector; 150E21FP tector; 150E21K tector; 150E21P tector; 150E22 tector; 150E22FP tector; 150E22K tector; 150E22P tector; 150E24 tector; 150E24K tector; 150E25 tector; 150E25K tector; 150E25W tector; 150E25WS tector; 150E28 tector; 150E28K tector; 150E28W tector; 150E28WS tector; 150E30 tector; 150E30FP tector; 150E30K tector; 150E30P tector; 160E18K tector; 160E18 tector; 160E18P tector; 160E21 tector; 160E21P tector; 160E22 tector; 160E22K tector; 160E22P tector; 160E24 tector; 160E24P tector; 160E25 tector; 160E25K tector; 160E25P tector; 160E28 tector; 160E28K tector; 160E28P tector; 160E30 tector; 160E30K tector; 160E30P tector) (4x2 & 4x4) (ABS-) 01.05-

19,5" KNORR SB-SN6
AXIAL (0°)

AV/F

EFR6312

EFR6313

2932005
CVP036K

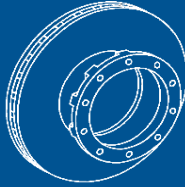
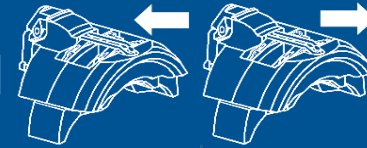
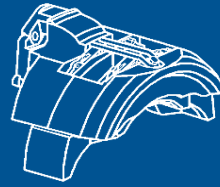
W0310IV34
98025300

09.A562.10
FCR319A
93175200

AR/R

Automotive

APPLICATION PAR VEHICULES
APPLICATION BY VEHICLES

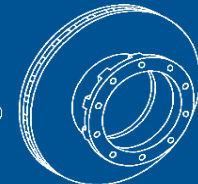
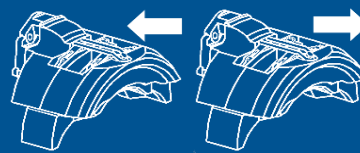
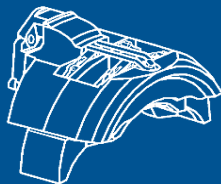


IVECO (TRUCKS) ...

EUROCARGO (170E15; 170E18; 170E18K; 170E23; 170E23K; 170E27; 180E18; 180E18K; 180E23; 180E23K; 180E27; 260E23KE) (4x2 & 6x4) 01.91-12.99	22,5"	BENDIX ADB 4300	AV/F	EFR7900	EFR7901	2901105	W0400IV 98022400 ou/or W0250IV 98022500	09.6739.20 FCR132A 93085200
EUROCARGO (180E24K tector; 180E25K tector; 180E28K tector; 180E28P tector; 180E28 tector; 180E30K tector; 180E30P tector; 180E30 tector; 190E25P tector; 190E25 tector; 190E28P tector; 190E28 tector; 190E30P tector; 190E30 tector; 225E28 tector; 230E25 tector; 230E28 tector; 230E30 tector; 320E28T tector) (4x2 & 6x2) 01.99-	22,5"	KNORR SB-SN7 AXIAL (-12°)	AV/F	EFR7300	EFR7301	2920200764 2927801 292530539	W0310IV34 98025300	DF70006 09.9983.10 FCR254A 93142900
		KNORR SB-SN7 AXIAL (-12°) POTENTIO. CONTINU	AR/R	EFR7304	EFR7305			
EUROCARGO (260E27KE; 260E28K tector; 260E28KE tector) (6x4) 01.00-	19,5"	KNORR SB-SN6 AXIAL (5°+)	AV/F	EFR6310	EFR6311	2932005 CVP036K	W0310IV34 98025300	09.A563.30 FCR239A 93127600
EUROCARGO (320E28 tector; 320E28 tector; 320E28T tector; 320E28T tector) (6x2) 01.00-	22,5"	KNORR SB-SN7 AXIAL (-12°)	AV/F	EFR7300	EFR7301	2920200764 2927801 292530539	W0310IV34 98025300	09.A563.30 FCR239A 93127600
EUROCARGO (260E23; 260E23T; 280E23; 280E23P; 280E23T; 320E27; 320E27P; 320E27T) (4x2 & 4x4) court 09.90-12.00	19,5"	BENDIX ADB 3700	AV/F	EFR6900	EFR6901	2903203	W0400IV 98022400 ou/or W0250IV 98022500	
EUROCARGO (260E23; 260E23T; 280E23; 280E23P; 280E23T; 320E27; 320E27P; 320E27T) (4x2 & 4x4) long 01.91-12.00	19,5"	BENDIX ADB 3700	AV/F	EFR6902	EFR6903	2903203	W0400IV 98022400 ou/or W0250IV 98022500	

Automotive

APPLICATION PAR VEHICULES APPLICATION BY VEHICLES



IVECO (TRUCKS) ..!..

EUROSTAR (LD190E38P; LD190E39FP; LD190E39P;
LD190E40; LD190E42; LD190E42P; LD190E43; LD190E43FP;
LD190E43P; LD190E47; LD190E52; LD260E38P; LD260E42P;
LD260E47; LD260E52; LD440E38T; LD440E38TZ; LD440E39T/P;
LD440E39T; LD440E40T; LD440E42T/P; LD440E42TZ;
LD440E43T/P; LD440E47T/P; LD440E47TZ; LD440E48T/P;
LD440E52T; LD440E52TZ) (4x2 & 6x4) 01.91-12.99 -
Ch.043134

22,5"

AV/F

BENDIX ADB 4300

EFR7900

EFR7901

2901105

W0400IV
98022400
ou/or
W0250IV
98022500

09.6739.20
FCR132A
93085200

22,5"

AR/R

EUROSTAR (LD190E38P; LD190E39FP; LD190E39P;
LD190E40; LD190E42; LD190E42P; LD190E43;
LD190E43FP; LD190E43P; LD190E47; LD190E52;
LD260E38P; LD260E42P; LD260E47; LD260E52;
LD440E38T; LD440E38TZ; LD440E39T/P; LD440E39T;
LD440E40T; LD440E42T/P; LD440E42TZ; LD440E43T/P;
LD440E47T/P; LD440E47TZ; LD440E48T/P; LD440E52T;
LD440E52TZ) (4x2 & 6x4) 01.01-03.02 **Ch.043135-**

22,5"

AV/F

KNORR SB-SN7
AXIAL (-12°)

EFR7300

EFR7301

2920200764
2927801
292530539

W0310IV34
98025300

09.9983.40
FCR173A
93096100

22,5"

AR/R

KNORR SB-SN7
AXIAL (-12°)
POTENTIO. CONTINU

EFR7304

EFR7305

EUROSTAR (LD240E38; LD240E42FS; LD240E42PS;
LD240E47PS; LD240E52PS; LD260E39FP; LD260E39P;
LD260E40; LD260E43FP; LD260E43Y/PS; LD260E48Y/PS;
LD400E38TX/P; LD400E42TX/P; LD440E38TX/P;
LD440E39TX; LD440E39TX/P; LD440E40TX/P;
LD440E42TX/P; LD440E43TX/P) (6x2 & 6x2/2/4)01.91-
12.99 -**Ch.043134**

22,5" BENDIX ADB 4300

AV/F

EFR7900

EFR7901

2901105

W0400IV
98022400
ou/or
W0250IV
98022500

09.6739.20
FCR132A
93085200

22,5"

AV/F

KNORR SB-SN7
AXIAL (-12°)

EFR7300

EFR7301

2920200764
2927801
292530539

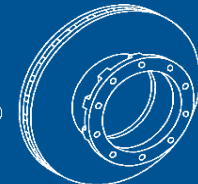
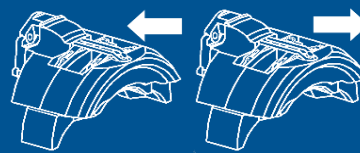
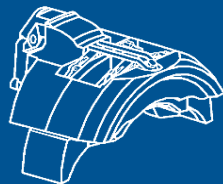
W0310IV34
98025300

09.9983.40
FCR173A
93096100

EUROSTAR (LD240E38; LD240E42FS; LD240E42PS;
LD240E47PS; LD240E52PS; LD260E39FP; LD260E39P;
LD260E40; LD260E43FP; LD260E43Y/PS; LD260E48Y/PS;
LD400E38TX/P; LD400E42TX/P; LD440E38TX/P;
LD440E39TX; LD440E39TX/P; LD440E40TX/P;
LD440E42TX/P; LD440E43TX/P) (6x2 & 6x2/2/4) 01.01-
03.02 **Ch.043135-**

Automotive

APPLICATION PAR VEHICULES
APPLICATION BY VEHICLES



IVECO (TRUCKS) ..!

EUROTECH MH (190E24; 190E24/P; 190E24K; 190E27/P;
190E27; 190E27K; 190E30/P; 190E30; 190E31; 190E31/P;
190E31K; 190E35/FP; 190E35/P; 190E35; 260E24Y/P;
260E24Y/PS; 260E24Y/PT; 260E27RY/PS; 260E27RY/PT;
260E27Y/P; 260E27Y/PS; 260E30Y/PS; 260E31Y/P; 260E31Y/PS;
260E31Y/PT; 260E35Y/P; 260E35Y/PT; 260E35Y/TN; 400E31TP;
400E35TP; 440E31T; 440E31TP; 440E35T/FP; 440E35T/P;
440E35T; 440E35TX/P) (4x2 & 6x2 & 6x2/2/4) 09.98-01.02

22,5" BENDIX ADB 4300

AV/F

EFR7900

EFR7901

2901105

W0400IV
98022400
ou/or
W0250IV
98022500

09.6739.20
FCR132A
93085200

EUROTECH MH (190E24; 190E24/P; 190E24K; 190E27/P;
190E27; 190E27K; 190E30/P; 190E30; 190E31; 190E31/P;
190E31K; 190E35/FP; 190E35/P; 190E35; 260E24Y/P;
260E24Y/PS; 260E24Y/PT; 260E27RY/PS; 260E27RY/PT;
260E27Y/P; 260E27Y/PS; 260E30Y/PS; 260E31Y/P; 260E31Y/PS;
260E31Y/PT; 260E35Y/P; 260E35Y/PT; 260E35Y/TN; 400E31TP;
400E35TP; 440E31T; 440E31TP; 440E35T/FP; 440E35T/P;
440E35T; 440E35TX/P) (4x2 & 6x2 & 6x2/2/4) 01.02-

22,5" KNORR SB-SN7
AXIAL (-12°)

AV/F

EFR7300

EFR7301

2920200764
2927801
292530539

W0310IV34
98025300

09.9983.40
FCR173A
93096100

EUROTECH MP (180E34; 180E38; 180E42; 190E34;
190E38; 190E39/FP; 190E39/P; 190E39; 190E40/P;
190E42/P; 190E42; 190E43/P; 190E43; 240E30PS; 240E34;
240E38; 240E42; 260E38P; 260E39Y/FP; 260E39Y/FS;
260E39Y/P; 260E39Y; 260E40; 260E42; 260E43Y/P;
260E43Y; 400E34T; 400E38T; 400E38TXP; 400E42T;
440E34T; 440E38T/P; 440E38T; 440E38TZ; 440E39T/FP-CT;
440E39T/P; 440E39T; 440E39TX/P; 440E40T/P;
440E40TXP; 440E42T/P; 440E42T; 440E42TZ; 440E43T/P;
440E43T; 440E43TX/P) (4x2 & 6x2 & 6x2/4 & 6x2/2/4 &
6x4) 01.91- -Ch.4196434

22,5" BENDIX ADB 4300

AV/F

EFR7900

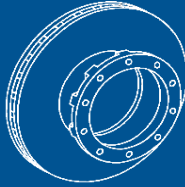
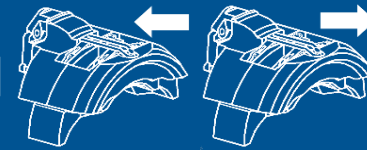
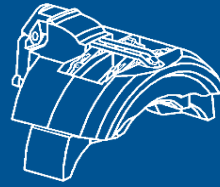
EFR7901

2901105

W0400IV
98022400
ou/or
W0250IV
98022500

09.6739.20
FCR132A
93085200

APPLICATION PAR VEHICULES
APPLICATION BY VEHICLES



IVECO (TRUCKS) ..!..

EUROTECH MP (180E34; 180E38; 180E42; 190E34; 190E38; 190E39/FP; 190E39/P; 190E39; 190E40/P; 190E42/P; 190E42; 190E43/P; 190E43; 240E30PS; 240E34; 240E38; 240E42; 260E38P; 260E39Y/FP; 260E39Y/FS; 260E39Y/P; 260E39Y; 260E40; 260E42; 260E43Y/P; 260E43Y; 400E34T; 400E38T; 400E38TXP; 400E42T; 440E34T; 440E38T/P; 440E38T; 440E38TZ; 440E39T/FP-CT; 440E39T/P; 440E39T; 440E39TX/P; 440E40T/P; 440E40TX/P; 440E42T/P; 440E42T; 440E42TZ; 440E43T/P; 440E43T; 440E43TX/P) (4x2 & 6x2 & 6x2/4 & 6x2/2/4 & 6x4) 01.91- **Ch.4196435-**

22,5" KNORR SB-SN7
AXIAL (-12°) AV/F

EFR7300

EFR7301

2920200764
2927801
292530539

W0310IV34
98025300

09.9983.40
FCR173A
93096100

EUROTECH MP (4300; 4500) (6x4 & 8x4) 01.02-

22,5" KNORR SB-SN7
AXIAL (-12°) AV/F

EFR7300

EFR7301

2920200764
2927801
292530539

W0310IV34
98025300

09.9983.40
FCR173A
93096100

EUROTECH MT (180E24; 180E24K; 180E27; 180E27K; 180E30R; 180E34R; 190E24; 190E24K; 190E27; 190E27K; 190E30; 190E30K; 400E30T; 400E34T) (4x2) 01.92- **-4196456 ou/or C044257**

22,5" BENDIX ADB 4300 AV/F

EFR7900

EFR7901

2901105

W0400IV
98022400
ou/or
W0250IV
98022500

09.6739.20
FCR132A
93085200

EUROTECH MT (180E24; 180E24K; 180E27; 180E27K; 180E30R; 180E34R; 190E24; 190E24K; 190E27; 190E27K; 190E30; 190E30K; 400E30T; 400E34T) (4x2) 01.92- **4196457 ou/or C044258-**

22,5" KNORR SB-SN7
AXIAL (-12°) AV/F

EFR7300

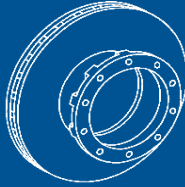
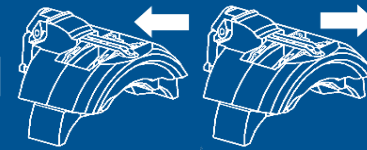
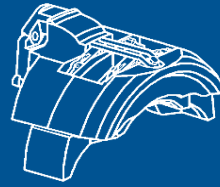
EFR7301

2920200764
2927801
292530539

W0310IV34
98025300

09.9983.40
FCR173A
93096100

APPLICATION PAR VEHICULES APPLICATION BY VEHICLES



IVECO (TRUCKS) ..!..

EUROTRAKKER (MP180E24W Cursor; MP180E25W; MP190E24H Cursor; MP190E30H; MP190E30W; MP190E31H Cursor; MP190E31W Cursor; MP190E34H; MP190E34W; MP190E35H Cursor; MP190E35W Cursor; MP190E37H; MP190E37W; MP190E38W Cursor; MP190E42H; MP190E42W; MP190E44W Cursor; MP190E47W; MP260E27H Cursor; MP260E30H; MP260E30W; MP260E31HB Cursor; MP260E31H Cursor; MP260E34H; MP260E34W; MP260E35H Cursor; MP260E35W Cursor; MP260E37H; MP260E37W; MP260E38H Cursor; MP260E38W Cursor; MP260E42H; MP260E42W; MP260E44H Cursor; MP260E44W Cursor; MP260E47H; MP260E47W; MP340E34H; MP340E35HB Cursor; MP340E35H Cursor; MP340E37H; MP340E38HB Cursor; MP340E38H Cursor; MP340E42H; MP340E44HB Cursor; MP340E44H Cursor) (4x2 & 4x4 & 6x4 & 6x6 & 8x4/4 & 8x8/4) 01.93-07.07

AV/F
22,5" AXIAL (-12°)
KNORR SB-SN7
POTENTIO. CONTINU

EFR7304

EFR7305

2920200764
2927801
292530539

W0310IV34
98025300

DF70006
09.9983.10
FCR254A
93142900

TM

AR/R

EUROTRAKKER (MP380E34H; MP380E34W; MP380E35H Cursor; MP380E35W Cursor; MP380E37H; MP380E37W; MP380E38HB Cursor; MP380E38H Cursor; MP380E38W Cursor; MP380E42H; MP380E42W; MP380E44HB Cursor; MP380E44H Cursor; MP380E44W Cursor; MP380E47H; MP380E47W; MP400E34HT; MP400E35HT Cursor; MP400E37HT; MP400E37WT; MP400E42HT; MP400E42WT; MP410E35H Cursor; MP410E37H; MP410E37W; MP410E38HB Cursor; MP410E38H Cursor; MP410E42H; MP410E42W; MP410E44HB Cursor; MP410E44H Cursor; MP410E47H; MP410E47W; MP440E34HT; MP440E37HT; MP440E38HT Cursor; MP440E42HT; MP440E44HT Cursor; MP440E47HT; MP720E37HT; MP720E37WT; MP720E38HT Cursor; MP720E42HT; MP720E42WT; MP720E44HT Cursor; MP720E47HT; MP720E48HT Cursor) (4x2 & 4x4 & 6x4 & 6x6 & 8x4/4 & 8x8/4) 01.93-07.07

AV/F
22,5" AXIAL (-12°)
KNORR SB-SN7
POTENTIO. CONTINU

EFR7304

EFR7305

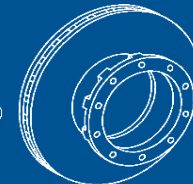
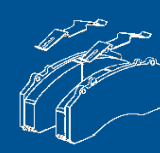
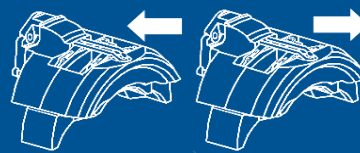
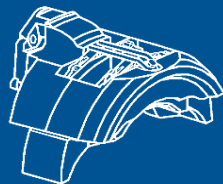
2920200764
2927801
292530539

W0310IV34
98025300

DF70006
09.9983.10
FCR254A
93142900

AR/R

APPLICATION PAR VEHICULES APPLICATION BY VEHICLES



IVECO (TRUCKS) ..!

EUROTRAKKER (MP180E24W Cursor; MP180E25W; MP190E24H Cursor; MP190E30H; MP190E30W; MP190E31H Cursor; MP190E31W Cursor; MP190E34H; MP190E34W; MP190E35H Cursor; MP190E35W Cursor; MP190E37H; MP190E37W; MP190E38W Cursor; MP190E42H; MP190E42W; MP190E44W Cursor; MP190E47W; MP260E27H Cursor; MP260E30H; MP260E30W; MP260E31HB Cursor; MP260E31H Cursor; MP260E34H; MP260E34W; MP260E35H Cursor; MP260E35W Cursor; MP260E37H; MP260E37W; MP260E38H Cursor; MP260E38W Cursor; MP260E42H; MP260E42W; MP260E44H Cursor; MP260E44W Cursor; MP260E47H; MP260E47W; MP340E34H; MP340E35HB Cursor; MP340E35H Cursor; MP340E37H; MP340E38HB Cursor; MP340E38H Cursor; MP340E42H; MP340E44HB Cursor; MP340E44H Cursor) (4x2 & 4x4 & 6x4 & 6x6 & 8x4/4 & 8x8/4) 08.07-

22,5"

KNORR SB-SN7
AXIAL (-12°)
POTENTIO. CONTINU
CLIP

AV/F

AR/R

AR/R

ABS+

EFR7332

EFR7333

2920200764
2927801
292530539

TM

W0310IV34
98025300

DF70006
09.9983.10
FCR254A
93142900

DF70007
09.9983.60
FCR318A
93253000

EUROTRAKKER (MP380E34H; MP380E34W; MP380E35H Cursor; MP380E35W Cursor; MP380E37H; MP380E37W; MP380E38HB Cursor; MP380E38H Cursor; MP380E38W Cursor; MP380E42H; MP380E42W; MP380E44HB Cursor; MP380E44H Cursor; MP380E44W Cursor; MP380E47H; MP380E47W; MP400E34HT; MP400E35HT Cursor; MP400E37HT; MP400E37WT; MP400E42HT; MP400E42WT; MP410E35H Cursor; MP410E37H; MP410E37W; MP410E38HB Cursor; MP410E38H Cursor; MP410E42H; MP410E42W; MP410E44HB Cursor; MP410E44H Cursor; MP410E47H; MP410E47W; MP440E34HT; MP440E37HT; MP440E38HT Cursor; MP440E42HT; MP440E44HT Cursor; MP440E47HT; MP720E37HT; MP720E37WT; MP720E38HT Cursor; MP720E42HT; MP720E42WT; MP720E44HT Cursor; MP720E47HT; MP720E48HT Cursor) (4x2 & 4x4 & 6x4 & 6x6 & 8x4/4 & 8x8/4) 08.07-

22,5"

KNORR SB-SN7
AXIAL (-12°)
POTENTIO. CONTINU
CLIP

AV/F

AR/R

AR/R

ABS+

EFR7332

EFR7333

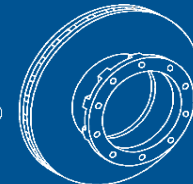
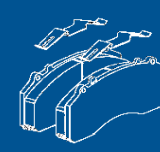
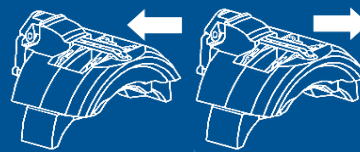
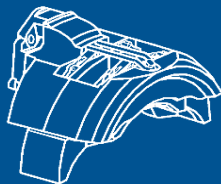
2920200764
2927801
292530539

W0310IV34
98025300

DF70006
09.9983.10
FCR254A
93142900

DF70007
09.9983.60
FCR318A
93253000

APPLICATION PAR VEHICULES APPLICATION BY VEHICLES



IVECO (TRUCKS) ..!..

STRALIS (450S33T; 450S38T; 450S42T; 460S36T; 490S38T; 490S40T; 490S42T; 490S46T; 490S48T; 530S36T; 570S38T; 570S42T; 570S46T; 600S56T; 800S46TZ; 800S56TZ; AD190S27; AD190S30; AD190S31; AD190S33; AD190S35; AD190S36; AD190S40; AD190S42; AD190S43; AD190S45; AD190S46; AD190S48; AD260S27; AD260S27CNG; AD260S30; AD260S30CNG; AD260S31; AD260S33; AD260S35; AD260S36; AD260S40; AD260S42; AD260S43; AD260S45; AD260S46; AD260S48; AD320S36; AD320S42; AD320S45; AD320S46; AD440S31; AD440S33; AD440S35; AD440S36; AD440S40; AD440S42; AD440S43; AD440S45; AD440S46; AD440S48; AS190S40; AS190S42; AS190S43; AS190S45; AS190S46; AS190S48) (4x2 & 6x2 & 6x2/4 & 6x2/2/4 & 6x4 & 8x2/6) 01.02-05.07

22,5" KNORR SB-SN7
AXIAL (-12°)

AV/F

AR/R

AV/F

AR/R

EFR7301

EFR7300

2920200764
2927801
292530539

W0310V34
98025300

DF70006
09.9983.10
FCR254A
93142900

TM

STRALIS (AS190S50; AS260S40; AS260S42; AS260S43; AS260S45; AS260S46; AS260S48; AS260S50; AS260S54; AS260S56; AS320S50; AS440S40; AS440S42; AS440S43; AS440S45; AS440S46; AS440S48; AS440S50; AS440S54; AS440S56; AT190S27; AT190S31; AT190S33; AT190S35; AT190S36; AT190S40; AT190S42; AT190S43; AT190S45; AT190S46; AT190S48; AT260S27; AT260S27CNG; AT260S30; AT260S31; AT260S33; AT260S35; AT260S36; AT260S40; AT260S42; AT260S43; AT260S45; AT260S46; AT260S48; AT320S42; AT320S45; AT320S46; AT440S31; AT440S33; AT440S33CNG; AT440S35; AT440S36; AT440S40; AT440S42; AT440S43; AT440S45; AT440S46; AT440S48; AT440S50; AT440S56; ES440S48; ES440S54) (4x2 & 6x2 & 6x2/4 & 6x2/2/4 & 6x4 & 8x2/6) 01.02-05.07

22,5" KNORR SB-SN7
AXIAL (-12°)

EFR7301

EFR7300

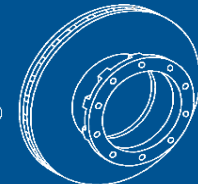
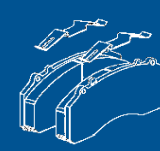
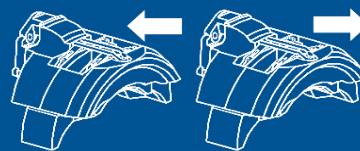
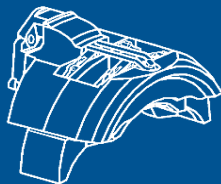
2920200764
2927801
292530539

W0310V34
98025300

DF70006
09.9983.10
FCR254A
93142900

Automotive

APPLICATION PAR VEHICULES APPLICATION BY VEHICLES



IVECO (TRUCKS) ..!..

STRALIS (450S33T; 450S38T; 450S42T; 460S36T; 490S38T; 490S40T; 490S42T; 490S46T; 490S48T; 530S36T; 570S38T; 570S42T; 570S46T; 600S56T; 800S46TZ; 800S56TZ; AD190S27; AD190S30; AD190S31; AD190S33; AD190S35; AD190S36; AD190S40; AD190S42; AD190S43; AD190S45; AD190S46; AD190S48; AD260S27; AD260S27CNG; AD260S30; AD260S30CNG; AD260S31; AD260S33; AD260S35; AD260S36; AD260S40; AD260S42; AD260S43; AD260S45; AD260S46; AD260S48; AD320S36; AD320S42; AD320S45; AD320S46; AD440S31; AD440S33; AD440S35; AD440S36; AD440S40; AD440S42; AD440S43; AD440S45; AD440S46; AD440S48; AS190S40; AS190S42; AS190S43; AS190S45; AS190S46; AS190S48) (4x2 & 6x2 & 6x2/4 & 6x2/2/4 & 6x4 & 8x2/6) 06.07-

22,5" KNORR SB-SN7
AXIAL (-12°)
POTENTIO. CONTINU
CLIP

AV/F

AR/R

AR/R

ABS+

AV/F

22,5" KNORR SB-SN7
AXIAL (-12°)
POTENTIO. CONTINU
CLIP

AR/R

AR/R

ABS+

EFR7332

EFR7333

2920200764
2927801
292530539

W0310IV34
98025300

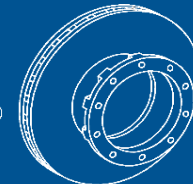
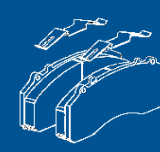
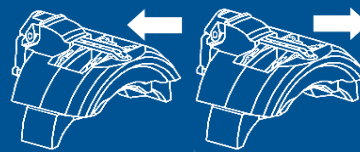
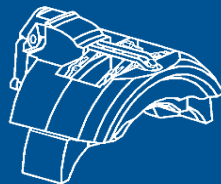
DF70006
09.9983.10
FCR254A
93142900

DF70007
09.9983.60
FCR318A
93253000

DF70006
09.9983.10
FCR254A
93142900

DF70007
09.9983.60
FCR318A
93253000

APPLICATION PAR VEHICULES
APPLICATION BY VEHICLES



IVECO (TRUCKS) ...

STRATOR (ASN440S42T; ASN440S42TX;
ASN440S45T; ASN440S45TX; ASN440S50T;
ASN440S50TX; ASN440S50TZ; ASN440S56T;
ASN440S56TX; ASN440S56TZ) (4x2 & 6x2/4 & 6x4)
04.10-

KNORR SB-SN7
22,5" AXIAL (-12°)
POTENTIO. CONTINU

AV/F

AR/R

EFR7304

EFR7305

2920200764
2927801
292530539

W0310IV34
98025300

DF70006
09.9983.10
FCR254A
93142900

TRAKKER (410T44; 410T48; 740T44T; 740T48T;
AD190T27; AD190T31; AD190T35W; AD190T36W;
AD190T38; AD190T38W; AD190T44; AD190T44W;
AD190T45; AD190T45W; AD19T45; AD260T31; AD260T31B;
AD260T33B; AD260T35; AD260T35B; AD260T35W;
AD260T36; AD260T36B; AD260T38B; AD260T38W;
AD260T44W; AD260T48; AD340T35; AD340T35B;
AD340T36; AD340T36B; AD340T38B; AD340T41;
AD340T41B; AD340T44; AD340T44B; AD340T45;
AD340T45/P; AD340T45B; AD380T35; AD380T36W;
AD380T38; AD380T38B; AD380T38W; AD380T42W;
AD380T44; AD380T44B; AD380T44W; AD380T45W;
AD380T48; AD380T50; AD400T35T; AD400T38T;
AD400T38WT; AD400T44T; AD400T44WT; AD410T35;
AD410T38; AD410T38B; AD410T38H; AD410T41; AD410T44;
AD410T44B; AD410T44W) (4x2 & 6x4 & 6x6 & 8x4/4 &
8x8/4) 10.04-07.07

KNORR SB-SN7
22,5" AXIAL (-12°)
POTENTIO. CONTINU

AV/F

AR/R

EFR7304

EFR7305

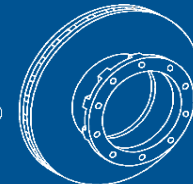
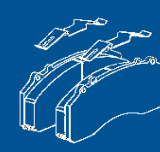
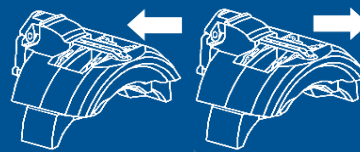
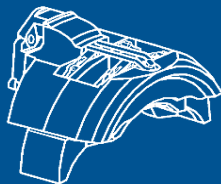
2920200764
2927801
292530539

W0310IV34
98025300

DF70006
09.9983.10
FCR254A
93142900

Automotive

APPLICATION PAR VEHICULES APPLICATION BY VEHICLES



IVECO (TRUCKS) ..!..

TRAKKER (AD180T27W; AD190T31; AD190T31W;
AD190T33W; AD190T35W; AD190T36W; AD190T38W;
AD190T41W; AD190T44W; AD190T45W; AD260T36W;
AD260T41W; AD260T45W; AD380T36W; AD380T41W;
AD380T45W; AD400T41WT; AD400T45WT; AD410T45W;
AD720T41WT; AD720T45WT; AT180T27W; AT190T31;
AT190T31W; AT190T33W; AT190T35W; AT190T36W;
AT190T38W; AT190T41W; AT190T44W; AT260T36W;
AT260T41W; AT260T45W; AT380T36W; AT380T41W;
AT380T45W; AT400T41WT; AT400T45WT; AT720T41WT;
AT720T45WT) (4x2 & 4x4 & 6x6 & 8x8) 10.04-07.07

AV/F

KNORR SB-SN7
22,5" AXIAL (-12°)
POTENTIO. CONTINU

EFR7304

EFR7305

2920200764
2927801
292530539

W0310IV34
98025300

DF70006
09.9983.10
FCR254A
93142900

AR/R

TRAKKER (AD190T31W; AD190T33; AD190T33W; AD190T35;
AD190T36; AD190T36W; AD190T38; AD190T41; AD190T45;
AD190T45W; AD260T31; AD260T33; AD260T35; AD260T36;
AD260T38; AD260T38/P; AD260T41; AD260T44; AD260T44/P;
AD260T45; AD260T50; AD340T36; AD340T41; AD340T45;
AD340T50; AD380T33; AD380T36; AD380T41; AD380T41W;
AD380T45; AD380T45W; AD380T50; AD400T36T; AD400T41T;
AD400T45T; AD400T50T; AD410T36; AD410T41; AD410T45;
AD410T50; AD440T38T; AD440T41T; AD440T44B; AD440T44T;
AD440T45T; AD440T50T; AD720T38T; AD720T38WT; AD720T41T;
AD720T44T; AD720T44WT; AD720T45T; AD720T48T) (4x2 & 4x4
& 6x4 & 6x6 & 8x4 & 8x4/4) 10.04-07.07

AV/F

KNORR SB-SN7
22,5" AXIAL (-12°)
POTENTIO. CONTINU

EFR7304

EFR7305

2920200764
2927801
292530539

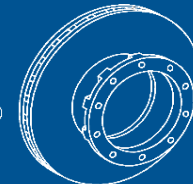
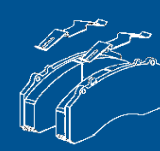
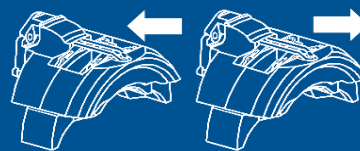
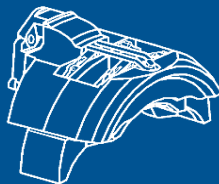
W0310IV34
98025300

DF70006
09.9983.10
FCR254A
93142900

AR/R

Automotive

APPLICATION PAR VEHICULES APPLICATION BY VEHICLES



IVECO (TRUCKS)/

TRAKKER (AD410T45; AD410T45W; AD410T48;
AD410T48B; AD410T50; AT190T27; AT190T31; AT190T35;
AT190T36W; AT190T38; AT190T38W; AT190T44;
AT190T44W; AT190T45; AT190T45W; AT260T31;
AT260T35; AT260T35W; AT260T36; AT260T38W;
AT260T44W; AT260T48; AT340T35; AT340T35B; AT340T36;
AT340T38; AT340T38W; AT340T41; AT340T44; AT340T44B;
AT340T45; AT34T38B; AT34T45/P; AT380T36W; AT380T38;
AT380T38W; AT380T44; AT380T44W; AT380T45W;
AT380T50; AT400T35T; AT400T38T; AT400T38WT;
AT400T42TH; AT400T44T; AT400T44WT; AT410T38B;
AT410T41; AT410T44; AT410T44B; AT410T45; AT410T48;
AT410T48B; AT410T50; AT410T54T; AT720T42T;
AT720T42WT) (4x2 & 6x4 & 6x6 & 8x4/4 & 8x8/4) 10.04-
07.07

AV/F

TM

KNORR SB-SN7
22,5" AXIAL (-12°)
POTENTIO. CONTINU

EFR7304

EFR7305

2920200764
2927801
292530539

W0310IV34
98025300

DF70006
09.9983.10
FCR254A
93142900

AR/R

TRAKKER (410T44; 410T48; 740T44T; 740T48T;
AD190T27; AD190T31; AD190T35W; AD190T36W;
AD190T38; AD190T38W; AD190T44; AD190T44W;
AD190T45; AD190T45W; AD19T45; AD260T31; AD260T31B;
AD260T33B; AD260T35; AD260T35B; AD260T35W;
AD260T36; AD260T36B; AD260T38B; AD260T38W;
AD260T44W; AD260T48; AD340T35; AD340T35B;
AD340T36; AD340T36B; AD340T38B; AD340T41;
AD340T41B; AD340T44; AD340T44B; AD340T45;
AD340T45/P; AD340T45B; AD380T35; AD380T36W;
AD380T38; AD380T38B; AD380T38W; AD380T42W;
AD380T44; AD380T44B; AD380T44W; AD380T45W;
AD380T48; AD380T50; AD400T35T; AD400T38T;
AD400T38WT; AD400T44T; AD400T44WT; AD410T35;
AD410T38; AD410T38B; AD410T38H; AD410T41; AD410T44;
AD410T44B; AD410T44W) (4x2 & 6x4 & 6x6 & 8x4/4 &
8x8/4) 08.07-

AV/F

KNORR SB-SN7
22,5" AXIAL (-12°)
POTENTIO. CONTINU
CLIP

EFR7332

EFR7333

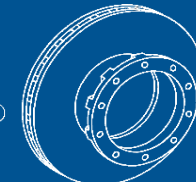
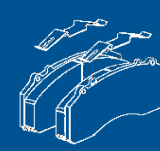
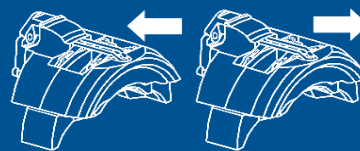
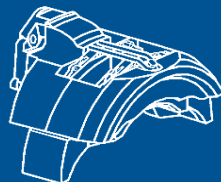
2920200764
2927801
292530539

W0310IV34
98025300

DF70006
09.9983.10
FCR254A
93142900

AR/R

APPLICATION PAR VEHICULES APPLICATION BY VEHICLES



IVECO (TRUCKS) ..!..

TRAKKER (AD180T27W; AD190T31; AD190T31W;
AD190T33W; AD190T35W; AD190T36W; AD190T38W;
AD190T41W; AD190T44W; AD190T45W; AD260T36W;
AD260T41W; AD260T45W; AD380T36W; AD380T41W;
AD380T45W; AD400T41WT; AD400T45WT; AD410T45W;
AD720T41WT; AD720T45WT; AT180T27W; AT190T31;
AT190T31W; AT190T33W; AT190T35W; AT190T36W;
AT190T38W; AT190T41W; AT190T44W; AT260T36W;
AT260T41W; AT260T45W; AT380T36W; AT380T41W;
AT380T45W; AT400T41WT; AT400T45WT; AT720T41WT;
AT720T45WT) (4x2 & 4x4 & 6x6 & 8x8) 08.07-

22,5" AV/F
KNORR SB-SN7
AXIAL (-12°)
POTENTIO. CONTINU
CLIP

AR/R

EFR7332

EFR7333

2920200764
2927801
292530539

W0310V34
98025300

DF70006
09.9983.10
FCR254A
93142900

TRAKKER (AD190T31W; AD190T33; AD190T33W;
AD190T35; AD190T36; AD190T36W; AD190T38; AD190T41;
AD190T45; AD190T45W; AD260T31; AD260T33; AD260T35;
AD260T36; AD260T38; AD260T38/P; AD260T41; AD260T44;
AD260T44/P; AD260T45; AD260T50; AD340T36; AD340T41;
AD340T45; AD340T50; AD380T33; AD380T36; AD380T41;
AD380T41W; AD380T45; AD380T45W; AD380T50;
AD400T36T; AD400T41T; AD400T45T; AD400T50T;
AD410T36; AD410T41; AD410T45; AD410T50; AD440T38T;
AD440T41T; AD440T44B; AD440T44T; AD440T45T;
AD440T50T; AD720T38T; AD720T38WT; AD720T41T;
AD720T44T; AD720T44WT; AD720T45T; AD720T48T) (4x2
& 4x4 & 6x4 & 6x6 & 8x4 & 8x4/4) 08.07-

22,5" AV/F
KNORR SB-SN7
AXIAL (-12°)
POTENTIO. CONTINU
CLIP

AR/R

EFR7332

EFR7333

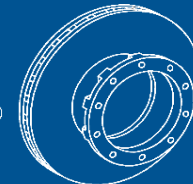
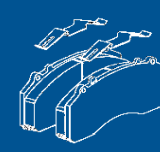
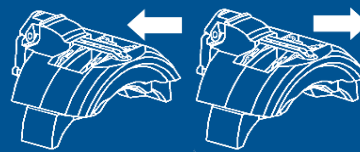
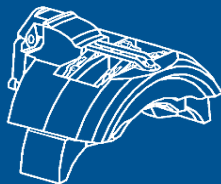
2920200764
2927801
292530539

W0310V34
98025300

DF70006
09.9983.10
FCR254A
93142900

Automotive

APPLICATION PAR VEHICULES APPLICATION BY VEHICLES



IVECO (TRUCKS) ..!

TRAKKER (AD410T45; AD410T45W; AD410T48;
AD410T48B; AD410T50; AT190T27; AT190T31; AT190T35;
AT190T36W; AT190T38; AT190T38W; AT190T44;
AT190T44W; AT190T45; AT190T45W; AT260T31;
AT260T35; AT260T35W; AT260T36; AT260T38W;
AT260T44W; AT260T48; AT340T35; AT340T35B; AT340T36;
AT340T38; AT340T38W; AT340T41; AT340T44; AT340T44B;
AT340T45; AT34T38B; AT34T45/P; AT380T36W; AT380T38;
AT380T38W; AT380T44; AT380T44W; AT380T45W;
AT380T50; AT400T35T; AT400T38T; AT400T38WT;
AT400T42TH; AT400T44T; AT400T44WT; AT410T38B;
AT410T41; AT410T44; AT410T44B; AT410T45; AT410T48;
AT410T48B; AT410T50; AT410T54T; AT720T42T;
AT720T42WT) (4x2 & 6x4 & 6x6 & 8x4/4 & 8x8/4) 08.07-

22,5"

KNORR SB-SN7
AXIAL (-12°)
POTENTIO. CONTINU
CLIP

AV/F

AR/R

EFR7332

EFR7333

2920200764
2927801
292530539

W0310IV34
98025300

DF70006
09.9983.10
FCR254A
93142900

TM

S-WAY (AS190S46FP; AS190S46P; AS260S51FP;
AS260S51P; AS260S51P; AS440S42TFP;
AS440S42TP; AS440S46TFP; AS440S46TP;
AS440S48TFP; AS440S48TP; AS440S51TFP;
AS440S51TP; AS440S51TP; AS440S57TFP;
AS440S57TP) (4x2 & 6x2 & 6x2/4) 07.19-

22,5" KNORR SN7

AV/F

AR/R

EFR73XX

EFR73XX

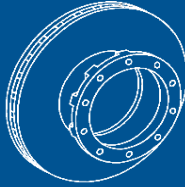
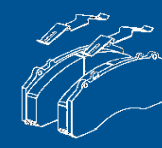
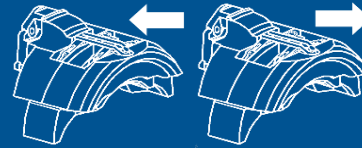
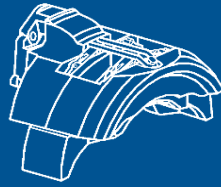
2920200764
2927801
292530539

W0310IV34
98025300

DF70007
09.9983.60
FCR318A
93253000

Automotive

APPLICATION PAR VEHICULES
APPLICATION BY VEHICLES



IVECO (TRUCKS)/

X-WAY (AS280X48P; AS280X51P; AS280X57P;
AS300X57; AS300X57P; AS360X57; AS360X57P;
AS440X42TP; AS440X46T; AS440X46TP;
AS440X48TP; AS440X51TP; AS440X51TP;
AS440X57TP; AS440X57TP) (4x2 & 6x2/4 & 6x4 &
8x4/4) 07.19-

	KNORR SN7	AV/F	EFR73XX	EFR73XX			
22,5"	KNORR SN7 DISC ABS-	AR/R	EFR73XX	EFR73XX	2920200764 2927801 292530539	W0310IV34 98025300	DF70006 09.9983.10 FCR254A 93142900 DF70007 09.9983.60 FCR318A 93253000
	KNORR SN7 DISC ABS+	AR/R	EFR73XX	EFR73XX			

KAROSA

KAROSA 01.00-

22,5"	MERITOR D ELSA 2	AV/F	EFR7664	EFR7665	2913105 CVP088K		
-------	------------------	------	----------------	----------------	--------------------	--	--

AGORA 01.97-

22,5"	MERITOR D3	AV/F	EFR7602	EFR7603	2903007 CVP013K	W0365RT 98022800	
-------	------------	------	----------------	----------------	--------------------	---------------------	--

SERIE B 01.97-12.06

22,5"	KNORR SB-SN7 AXIAL (-12°)	AV/F	EFR7301	EFR7300	2920200764 2927802 292530539		
-------	------------------------------	------	----------------	----------------	------------------------------------	--	--

SERIE C 01.07-

22,5"	MERITOR D ELSA 2	AV/F AR/R	EFR7666 EFR7664	EFR7667 EFR7665	2913105 CVP088K	W0290MA1 98032400	
-------	------------------	--------------	----------------------------------	----------------------------------	--------------------	----------------------	--

LECINENA (AXLE)

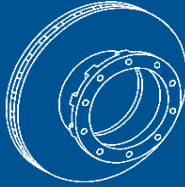
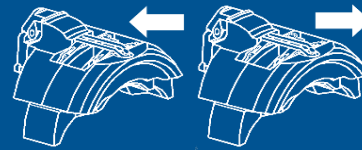
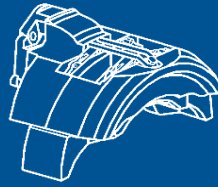
BRAKE KNORR WH. 19.5" 01.98-

19,5"	KNORR SB-SN6 AXIAL (5°+)		EFR6300	EFR6301	2932004 CVP036K		
-------	-----------------------------	--	----------------	----------------	--------------------	--	--

LECINENA 01.98-

22,5"	KNORR SK7		EFR6308	EFR6309	2926900604 2926901 292570539		
-------	-----------	--	----------------	----------------	------------------------------------	--	--

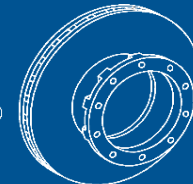
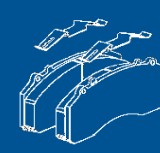
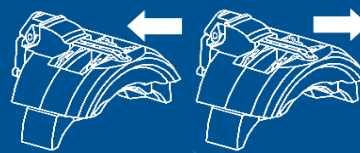
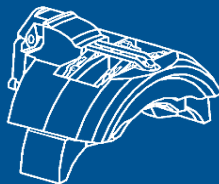
APPLICATION PAR VEHICULES
APPLICATION BY VEHICLES



LECINENA (AXLE)/.

LECINENA 01.98-	22,5" KNORR SB-SN7 AXIAL (0°)		EFR7302	EFR7303	2920200764 2927801 292530539	
					TM	
MAN (CARS ET BUS)						
BUS (A01; A03; A04; A13; A32; A33) (4x2) 01.99-	22,5" MERITOR ELSA 1	AV/F	EFR7640	EFR7641	2911303	W0400MA1 98024300
		AR/R	EFR7634	EFR7635		
CITY BUS (A20; A21; A22; A23; A24; A28; A31) (4x2) 01.99-	22,5" MERITOR ELSA 1	AV/F	EFR7646	EFR7647	2911303	W0400MA1 98024300
		AR/R	EFR7636	EFR7637		
CITY BUS (A25; A26; A30; A35) (4x2) 05.01-09.02	22,5" MERITOR ELSA 1	AV/F	EFR7640	EFR7641	2911303	W0400MA1 98024300
		AR/R	EFR7644	EFR7645		
CITY BUS (J14; J21; J22) (4x2) 01.99-	22,5" MERITOR ELSA 1	AV/F	EFR7646	EFR7647	2911303	W0400MA1 98024300
		AR/R	EFR7636	EFR7637		
CITY BUS (A91) (4x2) 03.04-	22,5" MERITOR ELSA 2	AV/F	EFR7702	EFR7703	2913105	W0290MA1 98032400
		AR/R	EFR7698	EFR7699	CVP088K	
FH322 (4x2) 01.95	22,5" MERITOR ELSA 1	AR/R	EFR7636	EFR7637	2911303	W0400MA1 98024300
FH422 (4x2) 01.95	22,5" MERITOR ELSA 1	AR/R	EFR7636	EFR7637	2911303	W0400MA1 98024300
FRH322 (4x2) 05.95-	22,5" MERITOR ELSA 1	AV/F	EFR7632	EFR7633	2911303	W0400MA1 98024300
FRH422 (4x2) 01.93	22,5" MERITOR D3	AV/F	EFR7600	EFR7601	2911307	W0400MA1 98024300
FRH422 (4x2) 05.95-	22,5" MERITOR ELSA 1	AV/F	EFR7632	EFR7633	2911303	W0400MA1 98024300

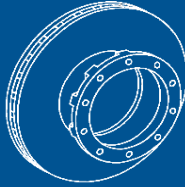
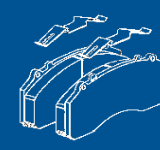
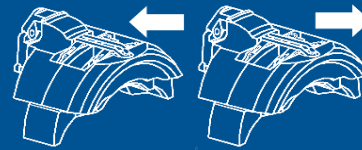
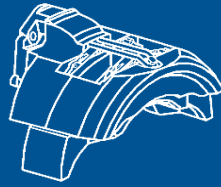
APPLICATION PAR VEHICULES APPLICATION BY VEHICLES



MAN (CARS ET BUS) ../..

LION'S INTERCITY (A91) (4x2) 05.04-	22,5" KNORR SB-SN7 AXIAL (0°) POTENTIO. CONTINU VIS	AV/F	EFR7345	EFR7344	2920200764 2927802 292530539	DF70001 09.9435.10 FCR214A 93087200 DF70002 09.9467.10 FCR215A 93087000
		AR/R				
LION'S CITY (A66; A76) (4x2) 01.00-	19,5" KNORR SB-SN6 AXIAL (5°+) KNORR SB-SN6 AXIAL (5°+) POTENTIO. CONTINU VIS KNORR SB-SN6 AXIAL (5°+) KNORR SB-SN6 AXIAL (5°+) POTENTIO. CONTINU VIS	AV/F	EFR6300	EFR6301	2932002 CVP036K	
		AV/F	EFR6315	EFR6314		
		AR/R	EFR6300	EFR6301		
		AR/R	EFR6315	EFR6314		
LION'S CITY (A20; A21; A23; A26) (4x2 & 6x2) 07.98-06.04	22,5" MERITOR ELSA 1	AV/F	EFR7642	EFR7643	2911303	W0290MA1 98032400
		AR/R				
LION'S CITY (A20; A22; A23; A26; A35; A39; A66) (4x2 & 6x2 & 6x2/4) 07.04-12.05	22,5" MERITOR D ELSA 2	AV/F	EFR7700	EFR7701	2913105 CVP088K	W0290MA1 98032400
		AR/R2	EFR7698	EFR7699		
		AR/R				

APPLICATION PAR VEHICULES APPLICATION BY VEHICLES

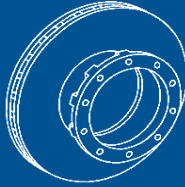
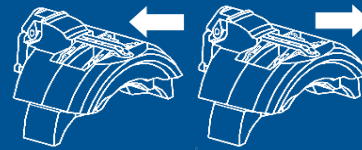
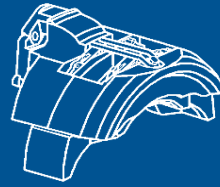


MAN (CARS ET BUS) ../..

			KNORR SB7 RADIAL (93°+) POTENTIO. CONTINU VIS	AV/F	EFR7316	EFR7317			
LION'S CITY (A20; A22; A23; A26; A35; A39; A66) (4x2 & 6x2 & 6x2/4) 01.06-	22,5"		KNORR SB7 RADIAL (3°+) POTENTIO. CONTINU VIS	AR/R2	EFR7340	EFR7341	2920200764	W0400MA1 98024300	09.7320.10 FCR144A 93071800
							2927802		
						292530539			
			KNORR SB7 RADIAL (93°+) POTENTIO. CONTINU VIS	AR/R	EFR7316	EFR7317			
LION'S CITY (A37; A47) (4x2) 01.00-12.03	22,5"		MERITOR D ELSA 2	AV/F	EFR7700	EFR7701	2913105	W0290MA1 98032400	09.7320.10 FCR144A 93071800
			MERITOR ELSA 2	AR/R	EFR7698	EFR7699	CVP088K		
LION'S CITY (A37; A47) (4x2) 01.04-	22,5"		KNORR SB7 RADIAL (93°+) POTENTIO. CONTINU VIS	AV/F	EFR7316	EFR7317	2920200764	W0400MA1 98024300	09.7320.10 FCR144A 93071800
				AR/R			2927802 292530539		
LION'S CITY (A78) (4x2) 01.00-	22,5"		MERITOR D ELSA 2	AV/F	EFR7700	EFR7701	2913105	W0290MA1 98032400	09.7320.10 FCR144A 93071800
				AR/R			CVP088K		
LION'S CLASSIC (A72; A74; A75) (4x2 & 6x2) 01.00-12.03	22,5"		MERITOR ELSA 2	AV/F	EFR7702	EFR7703	2913105	W0290MA1 98032400	
				AR/R			CVP088K		
LION'S CLASSIC (A72; A74; A75) (4x2 & 6x2) 01.04-	22,5"		KNORR SB-SN7 AXIAL (0°) POTENTIO. CONTINU VIS	AV/F	EFR7344	EFR7345	2920200764	W0400MA1 98024300	DF70001 09.9435.10 FCR214A 93087200
				AR/R			2927802 292530539		
									DF70002 09.9467.10 FCR215A 93087000

Automotive

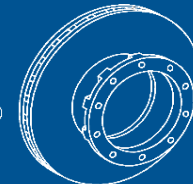
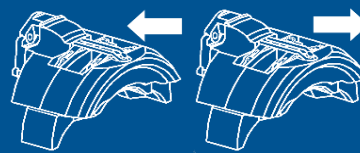
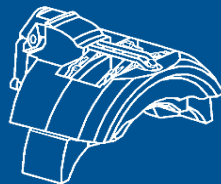
APPLICATION PAR VEHICULES
APPLICATION BY VEHICLES



MAN (CARS ET BUS) ../..

LION'S COACH (R07; R08) (4x2) 01.00-12.04	22,5" MERITOR ELSA 1	AV/F AR/R	EFR7642	EFR7643	2911303	W0290MA1 98032400	
							DF70001 09.9435.10 FCR214A 93087200
		AV/F			TM		
LION'S COACH (R07; R08; R09) (4x2 & 6x2) 01.05-	22,5" KNORR SB-SN7 AXIAL (0°) POTENTIO. CONTINU VIS	AR/R2	EFR7344	EFR7345	2920200764 2927802 292530539	W0400MA1 98024300	DF70002 09.9467.10 FCR215A 93087000
		AR/R					
LION'S REGIO (320; C320; L320; 360; C360; L360; 400; C400; L400) (4x2 & 6x2) 01.04-	22,5" KNORR SB-SN7 AXIAL (0°) POTENTIO. CONTINU VIS	AR/R2	EFR7344	EFR7345	2920200764 2927802 292530539	W0310NE3 98032300	DF70002 09.9467.10 FCR215A 93087000
		AR/R					
LION'S STAR (FRH313; FRH352; RH353; FRH402; RH403; FRH422) (4x2) 01.93-12.96	22,5" MERITOR ELSA 1	AV/F AR/R	EFR7632 EFR7636	EFR7633 EFR7637	2911303	W0400MA1 98024300	09.7320.10 FCR144A 93071800
		AV/F	EFR7632	EFR7633			DF70001 09.9435.10 FCR214A 93087200
LION'S STAR (FRH352; RH353; FRH402; RH403; RH414; RHS414; RH464; RHS464; RH484; RHS484) (4x2 & 6x2/4) 01.97-04.07	22,5" MERITOR ELSA 1	AR/R	EFR7636	EFR7637	2911303	W0400MA1 98024300	09.7320.10 FCR144A 93071800
		AV/F	EFR7632	EFR7633			
NG (NG262; NG263; NG312; NG313; NG323; NG363) (6x2) 07.98-12.14	22,5" MERITOR ELSA 1	AV/F	EFR7632	EFR7633	2911303	W0400MA1 98024300	09.7320.10 FCR144A 93071800

APPLICATION PAR VEHICULES
APPLICATION BY VEHICLES



MAN (CARS ET BUS) ..!..

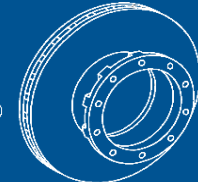
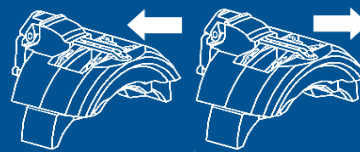
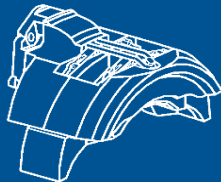
NG (NG313) (6x2) 07.98-12.14	22,5" MERITOR ELSA 1	AR/R	EFR7636	EFR7637	2911303	W0400MA1 98024300	09.7320.10 FCR144A 93071800
NG (NG353) (6x2) 07.98-12.14	22,5" MERITOR ELSA 1	AR/R	EFR7636	EFR7637	2911303	W0400MA1 98024300	09.7320.10 FCR144A 93071800
NL (NL202; NL222; NL223; NL262; NL263; NL283; NL312; NL313; NL323) (4x2) 08.92-	22,5" MERITOR ELSA 1	AV/F	EFR7632	EFR7633	2911303	W0400MA1 98024300	09.7320.10 FCR144A 93071800
		AR/R	EFR7636	EFR7637			
REISEBUS (A32 BVA) (4x2) 01.99-09.02	22,5" MERITOR ELSA 1	AV/F	EFR7642	EFR7643	2911303	W0400MA1 98024300	09.7320.10 FCR144A 93071800
		AR/R					

MAN (TRUCKS)

E2000 (26.310FAVLC; 26.360FAVLC; 26.410DFARC; 26.410DFRC; 26.410FAVLC; 26.460DFARC; 26.460DFLS; 26.460DFLRS; 26.460FAVLC) (6x4 & 6x6) 05.00-	22,5" MERITOR ELSA 1	AV/F	EFR76XX	EFR76XX	2911303	W0400MA1 98024300	09.7320.10 FCR144A 93071800
E2000 (33.360DFLC; 33.360DFLK; 33.360DFLS; 33.410DFLC; 33.410DFLK; 33.410DFLS; 33.460DFLC; 33.460DFLK; 33.460DFLS; 33.600DFLS) (6x4) 05.00-	22,5" MERITOR ELSA 1	AV/F	EFR76XX	EFR76XX	2911303	W0400MA1 98024300	DF70002
							09.9467.10 FCR215A 93087000
							DF70001
							09.9435.10 FCR214A 93087200

Automotive

APPLICATION PAR VEHICULES
APPLICATION BY VEHICLES



MAN (TRUCKS)/.

F2000

(18.273F;18.273FL;18.273FLL;19.233FCCNG;19.273F;19.273FL;19.273FLL;19.273FLS;19.273FS;19.293FC;19.293FLC;19.293FLLC;19.293FLLS;19.293FLS;19.293FS;19.314FC;19.314FLC;19.314FLL;19.314FLLC;19.314FLLR;19.314FLLRC;19.314FLLRS;19.314FLLS;19.314FLLW;19.314FLRC;19.314FLRS;19.314FLS;19.314FN;19.314FRC;19.314FRS;19.314FS;19.323FC;19.323FLC;19.323FLLC;19.323FLLS;19.323FLS;19.323FS;19.343FC;19.343FLC;19.343FLLC;19.343FLLS;19.343FLS;19.343FS;19.364FC;19.364FLC;19.364FLL;19.364FLLC;19.364FLLR;19.364FLLRC;19.364FLLRS;19.364FLLS;19.364FLLW;19.364FLRC;19.364FLRS;19.364FLS;19.364FN;19.364FRC;19.364FRS;19.364FS;19.373FC;19.373FLC;19.373FLLC;19.373FLLRS;19.373FLLS;19.373FLRC;19.373FLRS;19.373FLS;19.373FN;19.373FRC;19.373FRS;19.373FS;19.403FC;19.403FLC;19.403FLLC;19.403FLLRS;19.403FLLS;19.403FLRC;19.403FLRS;19.403FLS;19.403FN;19.403FRC;19.403FRS;19.403FS;19.414FC;19.414FLC;19.414FLL;19.414FLLC;19.414FLLR;19.414FLLRC;19.414FLLRS;19.414FLLS;19.414FLRC;19.414FLRS;19.414FLS;19.414FN;19.414FRC;19.414FRS;19.414FS;19.423FC;19.423FLC;19.423FLLC;19.423FLLS;19.423FLS;19.423FN;19.423FS;19.463FC;19.463FLC;19.463FLLC;19.463FLLRS;19.463FLLS;19.463FLRC;19.463FLRS;19.463FLS;19.463FN;19.463FRC;19.463FRS;19.463FS;19.464FC;19.464FLC;19.464FLL;19.464FLLC;19.464FLLR;19.464FLLRC;19.464FLLRS;19.464FLLS;19.464FLLW;19.464FLRS;19.464FLS;19.464FNL;19.464FRC;19.464FRS;19.464FS;19.603FLS;19.604LS) (4x2 & 6x2 & 6x2/4 & 6x2/2/4 & 6x4 & 6x6) 01.94-04.02

22,5" MERITOR D3 01.94-12.96

EFR7600

EFR7601

09.7320.10
FCR144A
93071800

AV/F

2911303

W0400MA1
98024300

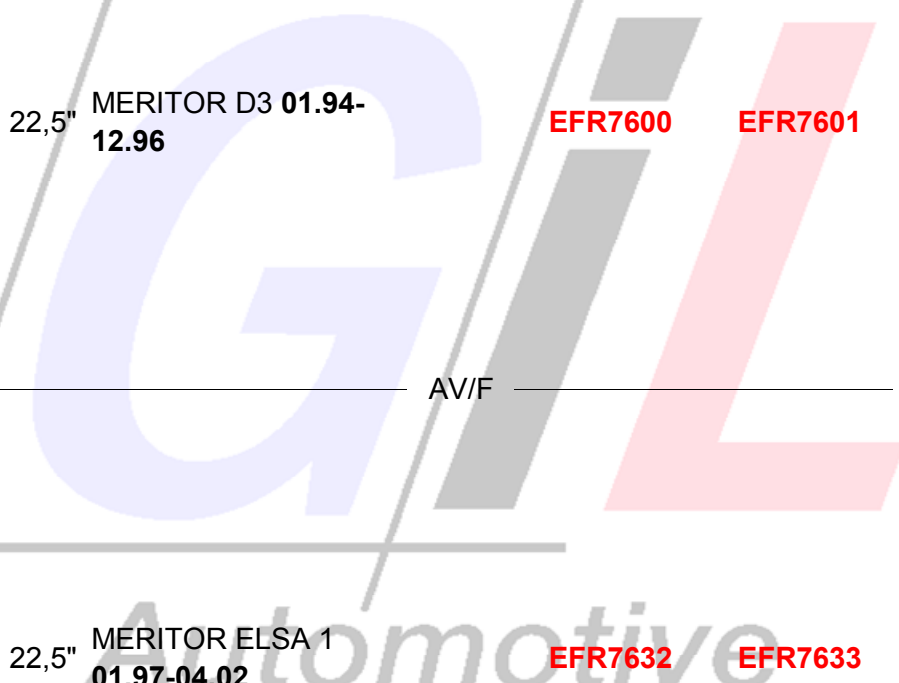
22,5" MERITOR ELSA 1 01.97-04.02

EFR7632

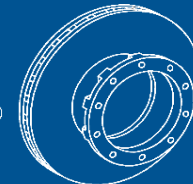
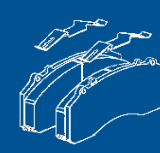
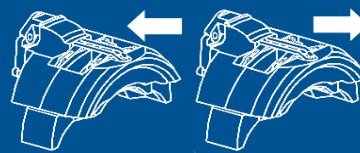
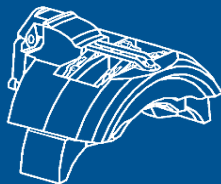
EFR7633

DF70001
09.9435.10
FCR214A
93087200

TM



APPLICATION PAR VEHICULES APPLICATION BY VEHICLES



MAN (TRUCKS) ..!..

F2000

(23.293FNLLC;23.314FNLLC;23.343FNLLC;23.364FNLLC;23.403FNLLC;23.414FNLLC;23.463FNLLC;23.464FNLLC;26.233FVLCCNG;26.233FVL-KO;26.273DFC;26.273DFLC;26.273DFLS;26.273DFS;26.273FNLC;26.273FNLLC;26.273FNLS;26.273FVLC;26.273FVLS;26.293DFC;26.293DFLC;26.293DFLS;26.293DFS;26.293FNLC;26.293FNLLC;26.293FNLS;26.293FVLC;26.293FVLS;26.314DFC;26.314DFLC;26.314DFLS;26.314DFS;26.314FNLC;26.314FNLLC;26.314FNLLRC;26.314FNLLW;26.314FNLLRC;26.314FNLS;26.314FVLC;26.314FVL-KO;26.314FVLR;26.314FVLS;26.323DFC;26.323DFLC;26.323DFLS;26.323DFS;26.323FNLC;26.323FNLLC;26.323FNLS;26.323FVLC;26.323FVLS;26.343DFC;26.343DFLC;26.343DFLS;26.343DFS;26.343FNLC;26.343FNLLC;26.343FNLS;26.343FVLC;26.343FVLS;26.364DFC;26.364DFLC;26.364DFLS;26.364DFS;26.364FNLC;26.364FNLLC;26.364FNLLRC;26.364FNLLW;26.364FNLLRC;26.364FNLS;26.364FVLC;26.364FVL-KO;26.364FVLR;26.364FVLS;26.373DFC;26.373DFLC;26.373DFLS;26.373DFS;26.373FNLC;26.373FNLLC;26.373FNLS;26.373FVLC;26.373FVLS;26.403DFC;26.403DFLC;26.403DFLS;26.403DFS;26.403FNLC;26.403FNLLC;26.403FNLS;26.403FVLC;26.403FVLS;26.414DFC;26.414DFLC;26.414DFLS;26.414DFS;26.414FNLC;26.414FNLLC;26.414FNLLRC;26.414FNLLW;26.414FNLLRC;26.414FNLS;26.414FVLC;26.414FVL-KO;26.414FVLR;26.414FVLS;26.423DFC;26.423DFLC;26.423DFLS;26.423DFS;26.423FNLC;26.423FNLLC;26.423FNLS;26.423FVLC;26.423FVLS;26.463DFC;26.463DFLC;26.463DFLS;26.463DFS;26.463FNLC;26.463FNLLC;26.463FNLLRC;26.463FNLLW;26.463FNLLRC;26.463FNLS;26.463FVLC;26.463FVLR;26.463FVLS;26.464DFC;26.464DFLC;26.464FNLC;26.464FNLLC;26.464FNLLRC;26.464FNLLW;26.464FNLLRC;26.464FNLS;26.464FVLC;26.464FVL-KO;26.464FVLR;26.464FVLS;26.603DFC;26.603DFLC;26.603DFLS;26.603DFS;26.604DFLS) (4x2 & 6x2 & 6x2/4 & 6x2/2/4 & 6x4 & 6x6)
01.94-04.02

22,5" MERITOR D3 01.94-12.96

EFR7600

EFR7601

09.7320.10
FCR144A
93071800

AV/F

2911303

W0400MA1
98024300

22,5" MERITOR ELSA 1 01.97-04.02

EFR7632

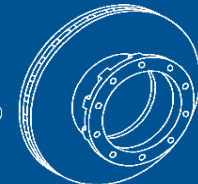
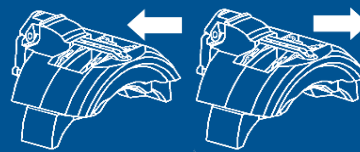
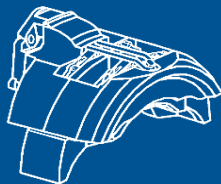
EFR7633

DF70001
09.9435.10
FCR214A
93087200

Automotive

TM

APPLICATION PAR VEHICULES
APPLICATION BY VEHICLES



MAN (TRUCKS) ..!

F2000

(27.273DFC;27.273DFS;27.293DFC;27.293DFS;27.314DFC;27.314DFS;27.314FVL;27.323DFC;27.323DFS;27.343DFC;27.343DFS;27.364DFC;27.364DFS;27.364FVL;27.373DFC;27.373DFS;27.403DFC;27.403DFS;27.414DFC;27.414DFS;27.414FVL;27.423DFC;27.423DFS;27.463DFC;27.463DFS;27.464DFC;27.464DFS;27.464FVL;27.603DFC;27.604DFS;33.323DFC;33.323DFK;33.323DFS;33.343DFC;33.343DFK;33.343DFS;33.364DFC;33.364DFK;33.364DFS;33.364DFRS;33.364DFS;33.373DFC;33.373DFK;33.373DFRS;33.373DFS;33.403DFC;33.403DFK;33.403DFRS;33.403DFS;33.414DFC;33.414DFK;33.414DFRS;33.414DFS;33.423DFC;33.423DFK;33.423DFRS;33.423DFS;33.463DFC;33.463DFK;33.463DFRS;33.463DFS;33.464DFC;33.464DFK;33.464DFRS;33.464DFS;33.603DFC;33.603DFRS;33.603DFS;33.604DFS;40.403DFAS;40.403DFS;40.463DFS) (4x2 & 6x2 & 6x2/4 & 6x2/2/4 & 6x4 & 6x6) 01.94-04.02

22,5"

MERITOR D3 01.94-12.96

AV/F

EFR7600

EFR7601

TM

2911303

W0400MA1
98024300

09.7320.10
FCR144A
93071800

22,5"

MERITOR ELSA 1 01.97-04.02

EFR7632

EFR7633

DF70001
09.9435.10
FCR214A
93087200

F90 (19.502F; 19.502FL; 19.502FLL; 19.502FLLS; 19.502FLS; 19.502FS; 24.502DF; 24.502DFK; 24.502DFS; 24.502FNL; 25.502DF; 25.502DFS; 26.502DF; 26.502DFLS; 26.502DFS; 26.502FNL; 26.502FNLL; 27.502DF; 33.502DF; DFS48.502VF) (4x2 & 6x2 & 6x4) 02.90-12.97

22,5" MERITOR D3

AV/F

EFR7600

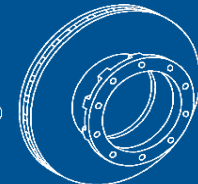
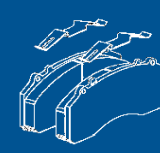
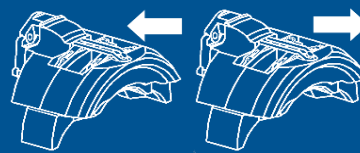
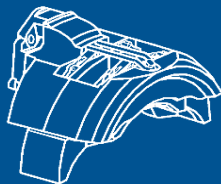
EFR7601

2911303

W0400MA1
98024300

09.7320.10
FCR144A
93071800

APPLICATION PAR VEHICULES APPLICATION BY VEHICLES



MAN (TRUCKS) ../..

L2000 (6.103; 8.103LC; 8.113LLC; 8.150FOC; 8.150FOCL; 8.153LC; 8.153LLC; 8.153LLS; 8.163LC; 8.163LLC; 8.163L-LF; 8.163LLRS; 8.163LLS; 8.163LLRC; 8.163LRC; 8.220FOC; 8.220FOCL; 8.223LC; 8.223LLC; 8.223LLS; 8.224LC; 8.224LLC; 8.224LLRC; 8.224LLRS; 8.224LLS; 8.224LRC; 9.153LC; 9.153LLC; 9.153LLS; 9.163LC; 9.163LLC; 9.163LLRC; 9.163LLRS; 9.163LLS; 9.163LRC; 9.223LC; 9.223LLC; 9.223LLS; 9.224LC; 9.224LLC; 9.224LLRC; 9.224LLRS; 9.224LLS; 9.224LRC; 10.150FOC; 10.153F; 10.153LC; 10.153LLC; 10.153LLS; 10.163LC; 10.163LLC; 10.163LLRS; 10.163LLS; 10.220FOC; 10.220FOCL; 10.223F; 10.223FL; 10.223LC; 10.223LLC; 10.223LLS; 10.224F; 10.224FL; 10.224LC; 10.224LLC; 10.224LLRC; 10.224LLRS; 10.224LLS; 10.224LRC) (4x2) 10.93-12.95

17,5" WABCO 1000 V-G

AV/F

EFR5008

EFR5009

TM
2905503

09.7164.10
FCR143A
93085300

L2000 (8.103LC;8.103LK;8.113LC(LE110C);8.113LK;8.113L-KI;8.113LLC;8.113LLC(LE110C);8.113LLRC(LE110C);8.113LRK;8.113LR-KI;8.145LC(LE140C);8.145LK(LE140C);8.145L-KI(LE140C);8.145LLC(LE140C);8.145L-LF;8.145LLRC(LE140C);8.145LLRS(LE140C);8.145LLS(LE140C);8.145LRC(LE140C);8.145LRK(LE140C);8.145LR-KILK(LE140C);8.145LRK-L(LE140C);8.150FOC;8.150FOCL;8.153LC;8.153LK;8.153LLC;8.153LLS;8.155L;8.155LC;8.155LK;8.155L-KI;8.155LLC;8.155L-LF;8.155LLRC;8.155LLRS;8.155LLS;8.155LR;8.155LRC;8.155LRK;8.155LR-KI;8.155LRK-L;8.163LC;8.163LC(LE160C);8.163LK;8.163L-KI;8.163LLC;8.163LLC(LE160C);8.163L-LF;8.163LLRC;8.163LLRC(LE160C);8.163LLRS;8.163LLS;8.163LRC;8.163LRC(LE160C);8.163LRK;8.163LR-KI;8.185LC(LE180C);8.185LK(LE180C);8.185L-KI(LE180C);8.185L-L(LE180C);8.185LLC(LE180C);8.185L-LF;8.185LLRC(LE180C);8.185LLRS(LE180C);8.185LLS(LE180C);8.185LRC(LE180C);8.185LRK(LE180C);8.185LR-KI(LE180C);8.185LRK-L(LE180C);8.220FOC;8.220FOCL;8.223LC;8.223LK;8.223LLC;8.223LLS;8.224LC;8.224LK;8.224L-KI;8.224LLC;8.224LLRC;8.224LLRS;8.224LLS;8.224LRC;8.224LRK;8.224LR-KI;8.225LC;8.225LK;8.225L-KI;8.225LLC;8.225LLRS(LE220C);8.225LLS(LE220C);8.225LRC;8.225LRK;8.225LR-KI) (4x2) 01.96-

17,5" WABCO PAN 17

AV/F

EFR5006

EFR5007

2928502
CVP032K

W0295MA1
98024400

09.8173.10
FCR146A
93085400

09.8172.10
FCR148A
93085500

AV/F
ABS+

AR/R

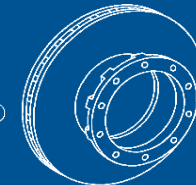
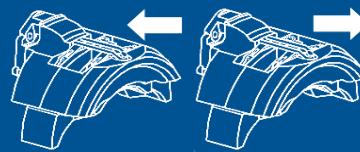
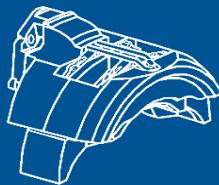
AR/R
ABS+

09.8173.10
FCR146A
93085400

09.8172.10
FCR148A
93085500

Automotive

APPLICATION PAR VEHICULES
APPLICATION BY VEHICLES



MAN (TRUCKS) ..!

L2000 (9.145LC;9.145LK;9.145L-
KI;9.145LLC;9.145LLRS(LE140C);9.145LLS(LE140C);9.
145LRC;9.145LRK;9.145LR-
KI;9.153LC;9.153LK;9.153LLC;9.155L;9.155LC;9.155LK
;9.155L-
KI;9.155LLC;9.155LLRC;9.155LLRS;9.155LLS;9.155LR
C;9.155LRK;9.155LR-KI;9.163LC;9.163LK;9.163L-
KI;9.163LLC;9.163LLRC;9.163LLRS;9.163LLS;9.163LR
C;9.163LRK;9.163LR-KI;9.185LC;9.185LK;9.185L-
KI;9.185LLC;9.185LLRS(LE180C);9.185LLS(LE180C);9.
185LRC;9.185LRK;9.185LR-
KI;9.223LC;9.223LK;9.223LLC;9.223LLS;9.224LC;9.224
LK;9.224L-
KI;9.224LLC;9.224LLRC;9.224LLRS;9.224LLS;9.224LR
C;9.224LRK;9.224LR-
KI;9.225LC;9.225LK(LE220C);9.225L-
KI(LE220C);9.225LK-
L(LE220C);9.225LLC;9.225LLRS(LE220C);9.225LLS(LE
220C);9.225LRC;9.225LRK(LE220C);9.225LR-
KI(LE220C);9.225LRK-KI(LE220C) (4x2) 01.96-

17,5" WABCO PAN 17

AV/F

AV/F
ABS+

AR/R

AR/R
ABS+

EFR5006

EFR5007

2928502
CVP032K

W0295MA1
98024400

TM

09.8173.10
FCR146A
93085400

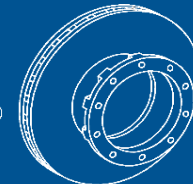
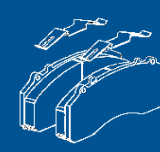
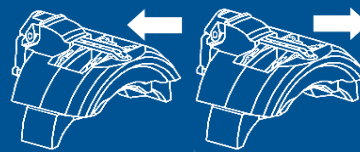
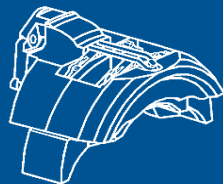
09.8172.10
FCR148A
93085500

09.8173.10
FCR146A
93085400
ou/or **93127700**
FCR216A

09.8172.10
FCR148A
93085500

Automotive

APPLICATION PAR VEHICULES
APPLICATION BY VEHICLES



MAN (TRUCKS)/

L2000 (10.145LC;10.145LK(LE140C);10.145L-KI(LE140C);10.145LK-L(LE140C);10.145LLC(LE140C);10.145LLRC(LE140C);10.145LLRS(LE140C);10.145LLS(LE140C);10.145LRC(LE140C);10.145LRK(LE140C);10.145LR-KI(LE140C);10.145LRK-L(LE140C);10.150FOC;10.153F;10.153LC;10.153LK;10.153LLC;10.153LLS;10.155LC;10.155LK;10.155L-KI;10.155LK-L;10.155LLC;10.155LLRC;10.155LRC;10.155LRK;10.155LR-KI;10.163F;10.163LC;10.163LC(LE160C);10.163LK;10.163L-KI;10.163LK-L;10.163LLC;10.163LLC(LE160C);10.163LLRC(LE160C);10.163LLRS;10.163LLS;10.163LRC(LE160C);10.163LRK;10.163LR-KI;10.163LRK-L;10.185LC(LE180C);10.185LK(LE180C);10.185LK-L(LE180C);10.185LLC(LE180C);10.185LL-KI(LE180C);10.185LLRC(LE180C);10.185LLRS(LE180C);10.185LLS(LE180C);10.185LRC(LE180C);10.185LRK(LE180C);10.185LR-KI(LE180C);10.185LRK-L(LE180C);10.220FOC;10.220FOCL;10.223F;10.223FL;10.223LC;10.223LK;10.223LLC;10.223LLS;10.224F;10.224FL;10.224LC;10.224LK;10.224L-KI;10.224LLC;10.224LLRC;10.224LLRS;10.224LLS;10.224LRC;10.224LRK;10.224LR-KI;10.225LC(LE220C);10.225LK(LE220C);10.225L-KI(LE220C);10.225LK-L(LE220C);10.225LLC(LE220C);10.225LLRC(LE220C);10.225LLRS(LE220C);10.225LLS(LE220C);10.225LRC(LE220C);10.225LRK(LE220C);10.225LR-KI(LE220C);10.225LRK-L(LE220C);12.185LC(LE180C);12.185LLC(LE180C);12.225LC(LE220C);12.225LLC(LE220C)) (4x2) 01.96-

17,5" WABCO PAN 17

AV/F

TM

AV/F
ABS+

AR/R

AR/R
ABS+

EFR5006

EFR5007

**2928502
CVP032K**

**W0295MA1
98024400**

**09.8173.10
FCR146A
93085400**

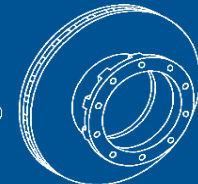
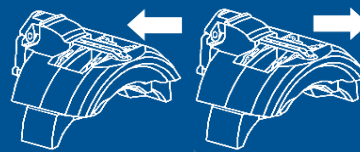
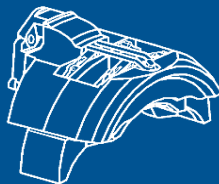
**09.8172.10
FCR148A
93085500**

**09.8173.10
FCR146A
93085400
ou/or
93127700
FCR216A**

**09.8172.10
FCR148A
93085500**

Automotive

APPLICATION PAR VEHICULES
APPLICATION BY VEHICLES



MAN (TRUCKS) ..I..

TGL (7.150FC; 7.150FLC; 7.150FLRC; 7.150FRC;
7.180FC; 7.180FLC; 7.180FLRC; 7.180FRC; 7.220FC;
7.220FLC; 7.220FLRC; 7.220FRC; 7.250FC; 7.250FLC;
7.250FLRC; 7.250FRC; 8.150FC; 8.150FK; 8.150FK-L;
8.150FLC; 8.150FLK; 8.150FLK-L; 8.150FLRC;
8.150FLRK; 8.150FLRK-L; 8.150FRC; 8.150FRK;
8.150FRK-L; 8.180FC; 8.180FK; 8.180FK-L; 8.180FLC;
8.180FLK; 8.180FLK-L; 8.180FLRC; 8.180FLRK;
8.180FLRK-L; 8.180FRC; 8.180FRK; 8.180FRK-L;
8.210FC; 8.210FK; 8.210FK-L; 8.210FLC; 8.210FLK;
8.210FLK-L; 8.210FLRC; 8.210FLRK; 8.210FLRK-L;
8.210FRC; 8.210FRK; 8.210FRK-L; 8.220FC; 8.220FK;
8.220FK-L; 8.220FLC; 8.220FLK; 8.220FLK-L;
8.220FLRC; 8.220FLRK; 8.220FLRK-L; 8.220FRC;
8.220FRK; 8.220FRK-L; 8.240FC; 8.240FK; 8.240FK-L;
8.240FLC; 8.240FLK; 8.240FLK-L; 8.240FLRC;
8.240FLRK; 8.240FLRK-L; 8.240FRC; 8.240FRK;
8.240FRK-L; 8.250FC; 8.250FFRK; 8.250FK; 8.250FK-
L; 8.250FLC; 8.250FLK; 8.250FLK-L; 8.250FLRC;
8.250FLRK; 8.250FLRK-L; 8.250FRC; 8.250FRK-L)
(4x2) 04.05-

KNORR SB-SN5
17,5" POTENTIO. CONTINU
VIS

AV/F

AR/R

EFR5304

EFR5305

2918302

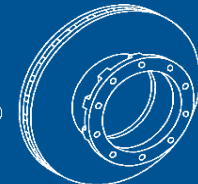
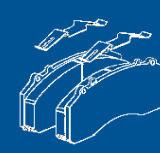
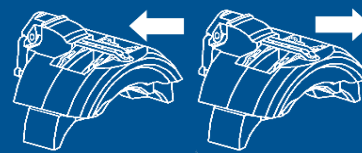
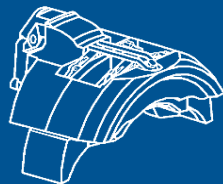
TM

09.B564.10
FCR330A
93138000

09.B562.10
FCR272A
93143100

Automotive

APPLICATION PAR VEHICULES APPLICATION BY VEHICLES



MAN (TRUCKS) ..I..

TGL (10.180FC; 10.180FK; 10.180FLC; 10.180FLK; 10.180FLRC; 10.180FLRK; 10.180FRC; 10.180FRK; 10.210FC; 10.210FK; 10.210FLC; 10.210FLK; 10.210FLRC; 10.210FLRK; 10.210FRC; 10.210FRK; 10.220FC; 10.220FK; 10.220FLC; 10.220FLK; 10.220FLRC; 10.220FLRK; 10.220FRC; 10.220FRK; 10.240FC; 10.240FK; 10.240FLC; 10.240FLK; 10.240FLRC; 10.240FLRK; 10.240FRC; 10.240FRK; 10.250FC; 10.250FK; 10.250FLC; 10.250FLK; 10.250FLRC; 10.250FLRK; 10.250FRC; 10.250FRK; 12.180FC; 12.180FK; 12.180FLC; 12.180FLK; 12.180FLRC; 12.180FLRK; 12.180FRC; 12.180FRK; 12.210FC; 12.210FK; 12.210FLC; 12.210FLK; 12.210FLRC; 12.210FLRK; 12.210FRC; 12.210FRK; 12.220FC; 12.220FK; 12.220FLC; 12.220FLK; 12.220FLRC; 12.220FLRK; 12.220FRC; 12.240FC; 12.240FK; 12.240FLC; 12.240FLK; 12.240FLRC; 12.240FLRK; 12.240FRC; 12.240FRK; 12.250FC; 12.250FK; 12.250FLC; 12.250FLK; 12.250FLRC; 12.250FLRK; 12.250FRC; 12.250FRK) (4x2) 04.05-

AV/F
KNORR SB-SN5
17,5" POTENTIO. CONTINU
VIS

EFR5304

EFR5305

2918302

TM

09.B564.10
FCR330A
93138000

M2000L (12.145LC; 12.145LK; 12.145LLC; 12.145LLRC; 12.145LRC; 12.145LRK; 12.163LC; 12.163LK; 12.163LLC; 12.163LLRC; 12.163LRC; 12.163LRK; 12.185LC; 12.185LK; 12.185LLC; 12.185LLRC; 12.185LRC; 12.185LRK; 12.224LC; 12.224LK; 12.224LLC; 12.224LLRC; 12.224LRC; 12.224LRK; 12.225LC; 12.225LK; 12.225LLC; 12.225LLRC; 12.225LRC; 12.225LRK; 12.255LC; 12.255LK; 12.255LLC; 12.255LLRC; 12.255LRC; 12.255LRK; 12.285LC; 12.285LK; 12.285LLC; 12.285LLRC; 12.285LRC; 12.285LRK; 14.163LC; 14.163LK; 14.163LLC; 14.163LLRC; 14.163LRC; 14.185LC; 14.185LK; 14.185LLC; 14.185LLRC; 14.185LRC; 14.185LRK; 14.224LA-LF; 14.225LA-LF; 14.255LAC; 14.255LAK; 14.255LAK-L; 14.255LA-LF; 14.255LARC; 14.255LARK; 14.255LK; 14.255LRK; 14.264LA-LF) (4x2 & 4x4) 08.95-

AV/F
17,5" WABCO PAN 17

EFR5006

EFR5007

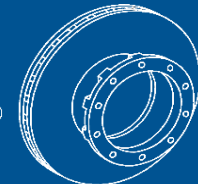
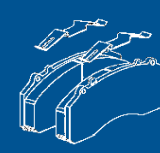
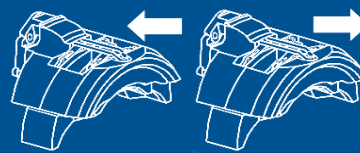
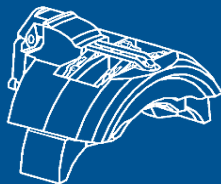
2928502
CVP032K

W0295MA1
98024400

09.8173.10
FCR146A
93085400

AR/R

APPLICATION PAR VEHICULES APPLICATION BY VEHICLES



MAN (TRUCKS) ..I..

M2000L (14.224LC; 14.224LLC; 14.224LLLC; 14.224LLRC;
14.224LLRC; 14.224LRC; 14.225LC(LE220B);
14.225LLC(LE220B); 14.225LLLC(LE220B);
14.225LLRC(LE220B); 14.225LLRC(LE220B);
14.225LRC(LE220B); 14.255LC(LE250B);
14.255LLC(LE250B); 14.255LLLC(LE250B);
14.255LLRC(LE250B); 14.255LLRC(LE250B);
14.255LRC(LE250B); 14.263LC; 14.263LLC; 14.263LLLC;
14.263LLRC; 14.263LLRC; 14.263LRC; 14.264LC;
14.264LLC; 14.264LLLC; 14.264LLRC; 14.264LLRC;
14.264LRC; 14.284LC; 14.284LLC; 14.284LLLC;
14.284LLRC; 14.284LLRC; 14.284LRC; 14.285LC(LE280B);
14.285LLC(LE280B); 14.285LLLC(LE280B);
14.285LLRC(LE280B); 14.285LLRC(LE280B);
14.285LRC(LE280B)) (4x2) 08.95-04.02

19,5"

KNORR SB-SN6
AXIAL (5°+)

AV/F

EFR6300

EFR6301

2932003
CVP036K

W0400MA
98032000

09.A461.10
FCR147A
93086900

TM

M2000L (14.224LC; 14.224LLC; 14.224LLLC; 14.224LLRC;
14.224LLRC; 14.224LRC; 14.225LC(LE220B);
14.225LLC(LE220B); 14.225LLLC(LE220B);
14.225LLRC(LE220B); 14.225LLRC(LE220B);
14.225LRC(LE220B); 14.255LC(LE250B);
14.255LLC(LE250B); 14.255LLLC(LE250B);
14.255LLRC(LE250B); 14.255LLRC(LE250B);
14.255LRC(LE250B); 14.263LC; 14.263LLC; 14.263LLLC;
14.263LLRC; 14.263LLRC; 14.263LRC; 14.264LC;
14.264LLC; 14.264LLLC; 14.264LLRC; 14.264LLRC;
14.264LRC; 14.284LC; 14.284LLC; 14.284LLLC;
14.284LLRC; 14.284LLRC; 14.284LRC; 14.285LC(LE280B);
14.285LLC(LE280B); 14.285LLLC(LE280B);
14.285LLRC(LE280B); 14.285LLRC(LE280B);
14.285LRC(LE280B)) (4x2) 05.02-

19,5"

KNORR SB-SN6
AXIAL (5°+)
POTENTIO. CONTINU
VIS

AV/F

EFR6314

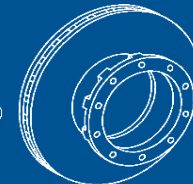
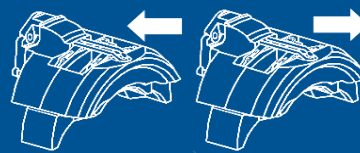
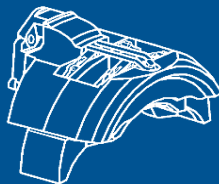
EFR6315

2932003
CVP036K

W0400MA
98032000

09.A461.10
FCR147A
93086900

APPLICATION PAR VEHICULES
APPLICATION BY VEHICLES



MAN (TRUCKS) ..I..

M2000M (12.224MC; 12.224MLC; 12.224MLLC;
12.224MLLRC; 12.224MLRC; 12.224MLRS;
12.224MLS; 12.224MRC; 12.225MC; 12.225MLC;
12.225MLLC; 12.225MLLRC; 12.225MLRC;
12.225MLRS; 12.225MLS; 12.225MRC; 12.255MC;
12.255MLC; 12.255MLLC; 12.255MLLRC; 12.255MLRC;
12.255MLS; 12.255MRC; 12.264MC; 12.264MLC;
12.264MLLC; 12.264MLLRC; 12.264MLRC;
12.264MLRS; 12.264MLS; 12.264MRC; 12.284MC;
12.284MLC; 12.284MLLC; 12.284MLLRC; 12.284MLRC;
12.284MLRS; 12.284MLS; 12.284MRC; 12.285MC;
12.285MLC; 12.285MLLC; 12.285MLLRC; 12.285MLRC;
12.285MLRS; 12.285MLS; 12.285MRC; 14.225MC;
14.225MLC; 14.225MLLC; 14.225MLLRC; 14.225MLRC;
14.225MLRS; 14.225MLS; 14.225MRC; 14.255MAK;
14.255MAK-L; 14.255MARK; 14.255MLRS; 14.255MLS;
14.264MAK; 14.264MAK-L; 14.264MARK; 14.285MLRS;
14.285MLS; 18.225MAC; 18.225MARC; 18.225MC;
18.225MLC; 18.225MLLC; 18.225MLLRC; 18.225MLRC;
18.225MRC; 18.285MAC; 18.285MARC; 18.285MLRS;
18.285MLS; 25.225MNLC; 25.225MNLLC;
25.225MNLLRC; 25.225MNLRC; 25.225MVLC;
25.285MNLC; 25.285MNLLC; 25.285MNLLRC;
25.285MNLRC; 25.285MVLC) (4x2 & 4x4 & 6x2/2/4)
08.95-

17,5" WABCO PAN 17

AV/F

AR/R

Automotive

TM

EFR5006

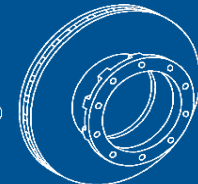
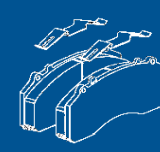
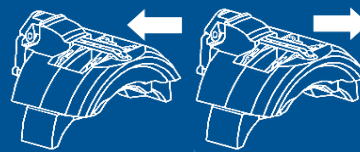
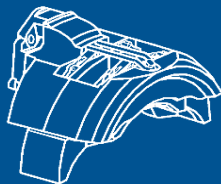
EFR5007

2928502
CVP032K

W0295MA1
98024400

09.8173.10
FCR146A
93085400

APPLICATION PAR VEHICULES
APPLICATION BY VEHICLES



MAN (TRUCKS) ..!

M2000M (14.224MC; 14.224MLC; 14.224MLLC;
14.224MLLRC; 14.224MLRC; 14.224MLRS; 14.224MLS;
14.224MRC; 14.255MC; 14.255MLC; 14.255MLLC;
14.255MLLRC; 14.255MLRC; 14.255MRC; 14.264MC;
14.264MLC; 14.264MLLC; 14.264MLLRC; 14.264MLRC;
14.264MLRS; 14.264MLS; 14.264MRC; 14.284MC;
14.284MLC; 14.284MLLC; 14.284MLLRC; 14.284MLRC;
14.284MLRS; 14.284MLS; 14.284MRC; 14.285MC(ME280C);
14.285MLC(ME280C); 14.285MLLC(ME280C);
14.285MLLRC(ME280C); 14.285MLRC(ME280C);
14.285MRC(ME280C); 18.285MC; 18.285MLC; 18.285MLLC;
18.285MLLRC; 18.285MLRC; 18.285MRC) (4x2) 08.95-
04.02

19,5" KNORR SB-SN6
AXIAL (5°+)

AV/F

EFR6300

EFR6301

TM
2932003
CVP036K

W0400MA
98032000

09.A461.10
FCR147A
93086900

M2000M (14.224MC; 14.224MLC; 14.224MLLC;
14.224MLLRC; 14.224MLRC; 14.224MLRS; 14.224MLS;
14.224MRC; 14.255MC; 14.255MLC; 14.255MLLC;
14.255MLLRC; 14.255MLRC; 14.255MRC; 14.264MC;
14.264MLC; 14.264MLLC; 14.264MLLRC; 14.264MLRC;
14.264MLRS; 14.264MLS; 14.264MRC; 14.284MC;
14.284MLC; 14.284MLLC; 14.284MLLRC; 14.284MLRC;
14.284MLRS; 14.284MLS; 14.284MRC; 14.285MC(ME280C);
14.285MLC(ME280C); 14.285MLLC(ME280C);
14.285MLLRC(ME280C); 14.285MLRC(ME280C);
14.285MRC(ME280C); 18.285MC; 18.285MLC; 18.285MLLC;
18.285MLLRC; 18.285MLRC; 18.285MRC) (4x2) 05.02-

19,5" KNORR SB-SN6
AXIAL (5°+)
POTENTIO. CONTINU
VIS

AV/F

EFR6314

EFR6315

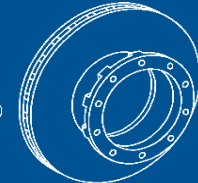
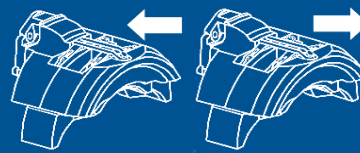
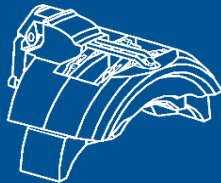
2932003
CVP036K

W0400MA
98032000

09.A461.10
FCR147A
93086900

Automotive

APPLICATION PAR VEHICULES
APPLICATION BY VEHICLES



MAN (TRUCKS) ..!

M2000M (18.224MC; 18.224MLC; 18.224MLLC;
18.224MLLRC; 18.224MLRC; 18.224MLRS;
18.224MLS; 18.224MRC; 18.225MLRS; 18.225MLS;
18.255MAC; 18.255MARC; 18.255MC; 18.255MLC;
18.255MLLC; 18.255MLLRC; 18.255MLRC;
18.255MLRS; 18.255MLS; 18.255MRC; 18.264MC;
18.264MLC; 18.264MLLC; 18.264MLLRC; 18.264MLRC;
18.264MLRS; 18.264MLS; 18.264MRC; 18.284MC;
18.284MLC; 18.284MLLC; 18.284MLLRC; 18.284MLRC;
18.284MLRS; 18.284MLS; 18.284MRC; 25.224MNLC;
25.224MNLLC; 25.224MNLLRC; 25.224MNLRC;
25.224MVLC; 25.255MNLC; 25.255MNLLC;
25.255MNLLRC; 25.255MNLRC; 25.255MVLC;
25.264MNLC; 25.264MNLLC; 25.264MNLLRC;
25.264MNLRC; 25.264MVLC; 25.284MNLC;
25.284MNLLC; 25.284MNLLRC; 25.284MNLRC;
25.284MVLC) (4x2 & 4x4 & 6x2/2/4)01.96-12.05

22,5" MERITOR D3

AV/F

EFR7600

EFR7601

2911303

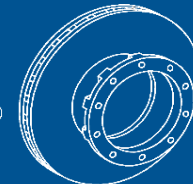
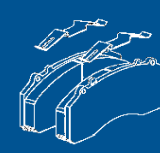
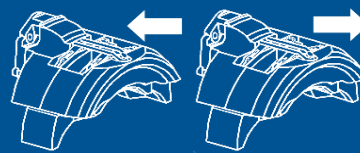
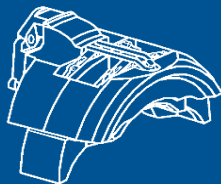
**W0400MA1
98024300**

**DF70001
09.9435.10
FCR214A
93087200**

TM

Automotive

APPLICATION PAR VEHICULES APPLICATION BY VEHICLES



MAN (TRUCKS)/.

TGA (18.310FC;18.310FK;18.310FKL;18.310FK-

L;18.310FLC;18.310FLK;18.310FLLC;18.310FLLRC;18.310FLLRS;1
8.310FLLRW;18.310FLLS;18.310FLLW;18.310FLRC;18.310FLRK;1
8.310FLRS;18.310FLS;18.310FLS-

TS;18.310FRC;18.320FC;18.320FK;18.320FKL;18.320FK-
L;18.320FLC;18.320FLK;18.320FLLC;18.320FLLRC;18.320FLLRS;1
8.320FLLRW;18.320FLLS;18.320FLLW;18.320FLRC;18.320FLRK;1
8.320FLRS;18.320FLS;18.320FLS-

TS;18.320FRC;18.350FC;18.350FK;18.350FK-
L;18.350FLC;18.350FLK;18.350FLLC;18.350FLLRC;18.350FLLRS;1
8.350FLLRW;18.350FLLS;18.350FLLW;18.350FLRC;18.350FLRK;1
8.350FLRS;18.350FLS;18.350FLS-

TS;18.350FRC;18.360FC;18.360FK;18.360FK-
L;18.360FLC;18.360FLK;18.360FLLC;18.360FLLRC;18.360FLLRS;1
8.360FLLRW;18.360FLLS;18.360FLLW;18.360FLRC;18.360FLRK;1
8.360FLRS;18.360FLS;18.360FLS-

TS;18.360FRC;18.380FLRC;18.380FLRS;18.390FC;18.390FK;18.39
0FK-
L;18.390FLC;18.390FLK;18.390FLLC;18.390FLLRC;18.390FLLRS;1
8.390FLLRW;18.390FLLS;18.390FLLW;18.390FLRC;18.390FLRK;1
8.390FLS;18.390FLS-TS;18.400FC;18.400FK;18.400FK-

L;18.400FLC;18.400FLK;18.400FLLC;18.400FLLRC;18.400FLLRS;1
8.400FLLRW;18.400FLLS;18.400FLLW;18.400FLRC;18.400FLRK;1
8.400FLRS;18.400FLS;18.400FLS-

TS;18.410FC;18.410FK;18.410FK-
L;18.410FLC;18.410FLK;18.410FLLC;18.410FLLRC;18.410FLLRS;1
8.410FLLRW;18.410FLLS;18.410FLLW) (4x2 & 6x2 & 6x2/4 &
6x2/2/4 & 6x4 & 6x6 & 8x2/4 & 8x4/4 & 8x4/6 & 8X6/4 &
8x8/4) 04.00-

TS;18.410FC;18.410FK;18.410FK-
L;18.410FLC;18.410FLK;18.410FLLC;18.410FLLRC;18.410FLLRS;1
8.410FLLRW;18.410FLLS;18.410FLLW) (4x2 & 6x2 & 6x2/4 &
6x2/2/4 & 6x4 & 6x6 & 8x2/4 & 8x4/4 & 8x4/6 & 8X6/4 &
8x8/4) 04.00-

22,5" MERITOR ELSA 1 -
09.01

EFR7648

EFR7649

2911303

**W0400MA1
98024300**

22,5" MERITOR D ELSA 2
10.01-03.03

EFR7694

EFR7695

**2913103
CVP088K**

**W0290MA1
98032400**

**DF70001
09.9435.10
FCR214A
93087200**

AV/F

22,5" KNORR SB-SN7
AXIAL (8°+) **03.03-**

EFR7336

EFR7337

**2920200764
2927801
292530539**

**W0400MA
98032000**

22,5" KNORR SB-SN7
AXIAL (0°) POTENTIO.
CONTINU VIS **03.03-**

EFR7326

EFR7327

22,5" MERITOR ELSA 1 -
09.01

AR/R

EFR7634

EFR7635

2911303

**W0400MA1
98024300**

22,5" MERITOR D ELSA 2
10.01-03.03

AR/R

EFR7716

EFR7717

**2913103
CVP088K**

**W0290MA1
98032400**

**DF70002
09.9467.10
FCR215A
93087000**

22,5" KNORR SB-SN7
AXIAL (0°) POTENTIO.
CONTINU VIS **03.03-**

AR/R

EFR7344

EFR7345

**2920200764
2927801
292530539**

**W0400MA
98032000**

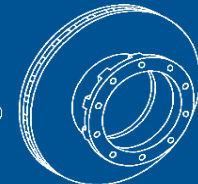
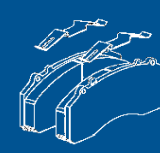
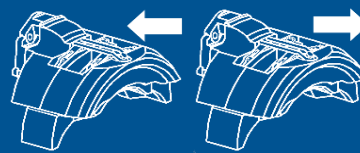
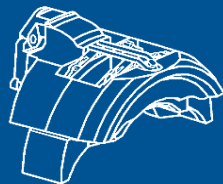
22,5" KNORR SB-SN7
AXIAL (0°) POTENTIO.
CONTINU VIS **03.03-**

AR/R2

EFR7344

EFR7345

APPLICATION PAR VEHICULES APPLICATION BY VEHICLES



MAN (TRUCKS) ..I..

TGA

(18.410FLRC;18.410FLRK;18.410FLRS;18.410FLS;18.410FLS-TS;18.410FRC;18.420FC;18.420FK;18.420FK-L;18.420FLC;18.420FLK;18.420FLLC;18.420FLLRC;18.420FLRW;18.420FLLW;18.420FLRC;18.420FLRK;18.420FLRS;18.420FRC;18.430FC;18.430FK;18.430FK-

22,5" MERITOR ELSA 1 -
09.01

EFR7648

EFR7649

2911303

**W0400MA1
98024300**

L;18.430FLC;18.430FLK;18.430FLLC;18.430FLLRC;18.430FLRS;18.430FLLRW;18.430FLLS;18.430FLLW;18.430FLRC;18.430FLRK;18.430FLRS;18.430FLS;18.430FLS-TS;18.440FC;18.440FK;18.440FK-

22,5" MERITOR D ELSA 2
10.01-03.03

EFR7694

EFR7695

**2913103
CVP088K**

**W0290MA1
98032400**

**DF70001
09.9435.10
FCR214A
93087200**

AV/F

L;18.440FLC;18.440FLK;18.440FLLC;18.440FLLRC;18.440FLRS;18.440FLLRW;18.440FLLS;18.440FLLW;18.440FLRC;18.440FLRK;18.440FLRS;18.440FLS;18.440FLS-TS;18.460FC;18.460FK;18.460FK-

22,5" KNORR SB-SN7
AXIAL (8°+) **03.03-**

EFR7336

EFR7337

**2920200764
2927801**

**W0400MA
98032000**

L;18.460FLC;18.460FLK;18.460FLLC;18.460FLLRC;18.460FLRS;18.460FLLRW;18.460FLLS;18.460FLLW;18.460FLRC;18.460FLRK;18.460FLRS;18.460FLS;18.460FLS-TS;18.480FC;18.480FK;18.480FK-

22,5" KNORR SB-SN7
AXIAL (0°) POTENTIO.
CONTINU VIS **03.03-**

EFR7326

EFR7327

292530539

L;18.480FLC;18.480FLK;18.480FLLC;18.480FLLRC;18.480FLRS;18.480FLLRW;18.480FLLS;18.480FLLW;18.480FLRC;18.480FLRK;18.480FLRS;18.480FLS;18.480FLS-TS;18.510FC;18.510FLC;18.510FLLC;18.510FLLRC;18.510FLLRS;18.510FLLRW;18.510FLLS;18.510FLLW;18.510FLRC;18.510FLRS;18.510FLS;18.510FRC;18.530FC;18.530FLC;18.530FLLC;18.530FLLRC;18.530FLLRS;18.530FLLRW;18.530FLS;18.530FLLW;18.530FLRC;18.530FLRS;18.530FLS;18.540FLC;18.540FLLC;18.540FLLRC;18.540FLLRS;18.540FLLS;18.540FLLW;18.540FLRC;18.540FLRS;18.540FLS) (4x2 & 6x2 & 6x2/4 & 6x2/2/4 & 6x4 & 6x6 & 8x2/4 & 8x4/4 & 8x4/6 & 8X6/4 & 8x8/4) **04.00-**

22,5" MERITOR ELSA 1 -
09.01

AR/R

EFR7634

EFR7635

2911303

**W0400MA1
98024300**

22,5" MERITOR D ELSA 2
10.01-03.03

AR/R

EFR7716

EFR7717

**2913103
CVP088K**

**W0290MA1
98032400**

22,5" KNORR SB-SN7
AXIAL (0°) POTENTIO.
CONTINU VIS **03.03-**

AR/R

EFR7344

EFR7345

**2920200764
2927801
292530539**

**W0400MA
98032000**

**DF70002
09.9467.10
FCR215A
93087000**

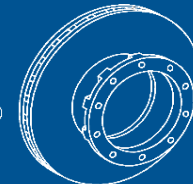
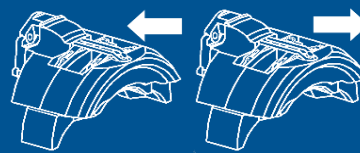
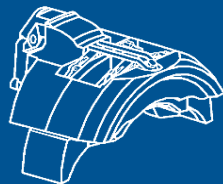
22,5" KNORR SB-SN7
AXIAL (0°) POTENTIO.
CONTINU VIS **03.03-**

AR/R2

EFR7344

EFR7345

APPLICATION PAR VEHICULES APPLICATION BY VEHICLES



MAN (TRUCKS) ..!..

TGA

(19.350FLRS;19.350FLS;19.350FRS;19.350FS;19.360FLRS;19.360FLS;19.360FRS;19.360FS;19.390FLRS;19.390FLS;19.390FRS;19.390FS;19.400FLRS;19.400FLS;19.400FRS;19.400FS;19.410FRS;19.410FS;19.430FLRS;19.430FLS;19.430FRS;19.430FS;19.440FLRS;19.440FLS;19.440FRS;19.440FS;19.460FRS;19.460FS;19.480FLRS;19.480FLS;19.480FRS;19.480FRS/M-
WW;19.480FS;19.480FS/M;24.350FLLRW;24.350FNLLC;24.350FNLLRC;24.350FNLLRW;24.350FNLLW;24.350FPLRS;24.350FPLS;24.360FLLRW;24.360FNLLC;24.360FNLLC/N;24.360FNLLRC;24.360FNLLRW;24.360FNLLW;24.360FPLRS;24.360FPLS;24.380FPLRS;24.380FPLS;24.390FLLRW;24.390FNLLC;24.390FNLLRC;24.390FNLLW;24.390FPLRS;24.390FPLS;24.400FLLRW;24.400FNLLC;24.400FNLLRC;24.400FNLLW;24.400FPLRS;24.400FPLS;24.410FNLLC;24.410FNLLRC;24.410FNLLRW;24.410FNLLW;24.420FPLRS;24.420FPLS;24.430FNLLC;24.430FNLLRC;24.430FNLLRW;24.430FNLLW;24.430FNLLRC;24.430FPLRS;24.430FPLS;24.440FNLLC;24.440FNLLRC;24.440FNLLRW;24.440FNLLW;24.440FNLLRC;24.440FPLRS;24.440FPLS;24.460FNLLC;24.460FNLLRC;24.460FNLLRW;24.460FNLLW;24.480FNLLC;24.480FNLLRC;24.480FNLLRW;24.480FNLLW;24.480FPLRS;24.480FPLS;24.510FNLLC/N;24.510FNLLRW;24.510FNLLW;24.530FNLLC;24.530FNLLRC;24.530FNLLRW;24.530FNLLW;24.530FPLRS;24.530FPLS;24.540FNLLC;24.540FNLLW) (4x2 & 6x2 & 6x2/4 & 6x2/2/4 & 6x4 & 6x6 & 8x2/4 & 8x4/4 & 8x4/6 & 8x6/4 & 8x8/4) 04.00-

22,5" MERITOR ELSA 1 -
09.01

EFR7648

EFR7649

2911303

**W0400MA1
98024300**

22,5" MERITOR D ELSA 2
10.01-03.03

EFR7694

EFR7695

**2913103
CVP088K**

**W0290MA1
98032400**

22,5" KNORR SB-SN7
AXIAL (8°+) **03.03-**

AV/F

EFR7336

EFR7337

**2920200764
2927801
292530539**

**W0400MA
98032000**

22,5" KNORR SB-SN7
AXIAL (0°) POTENTIO.
CONTINU VIS **03.03-**

EFR7326

EFR7327

22,5" MERITOR ELSA 1 -
09.01

AR/R

EFR7634

EFR7635

2911303

**W0400MA1
98024300**

22,5" MERITOR D ELSA 2
10.01-03.03

AR/R

EFR7716

EFR7717

**2913103
CVP088K**

**W0290MA1
98032400**

22,5" KNORR SB-SN7
AXIAL (0°) POTENTIO.
CONTINU VIS **03.03-**

AR/R

EFR7344

EFR7345

**2920200764
2927801
292530539**

**W0400MA
98032000**

22,5" KNORR SB-SN7
AXIAL (0°) POTENTIO.
CONTINU VIS **03.03-**

AR/R2

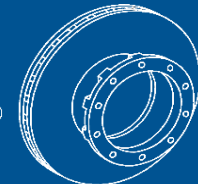
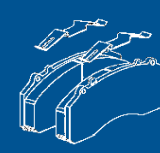
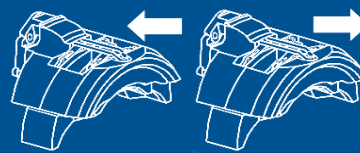
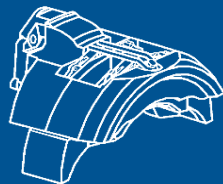
EFR7344

EFR7345

**DF70001
09.9435.10
FCR214A
93087200**

**DF70002
09.9467.10
FCR215A
93087000**

APPLICATION PAR VEHICULES APPLICATION BY VEHICLES



MAN (TRUCKS) ..I..

TGA

(26.280FNLC;26.280FNLLC;26.280FNLLW;26.310FDAK;26.310FDC;26.310FDHK;26.310FDK;26.310FDLC;26.310FDLK;26.310FDLRC;26.310FDLRK;26.310FDLRS;26.310FDLS;26.310FDRC;26.310FDRK;26.310FDRS;26.310FDRTM;26.310FDR-TM;26.310FDS;26.310FD-TM;26.310FNHLC;26.310FNHLS;26.310FNLC;26.310FNLLC;26.310FNLLRC;26.310FNLLRS;26.310FNLLRW;26.310FNLLS;26.310FNLLW;26.310FNLRC;26.310FNLRS;26.310FNLS;26.310FPLRS;26.310FPLS;26.310FVHLC;26.310FVHL-KO;26.310FVLC;26.310FV-LKO;26.310FVLR;26.310FVLS;26.320FDAK;26.320FDC;26.320FDHK;26.320FDK;26.320FDLC;26.320FDLK;26.320FDLRC;26.320FDLRK;26.320FDLRS;26.320FDLS;26.320FDRC;26.320FDRK;26.320FDRS;26.320FDRTM;26.320FDS;26.320FD-TM;26.320FNHLC;26.320FNHLS;26.320FNLC;26.320FNLLC;26.320FNLLRC;26.320FNLLRS;26.320FNLLRW;26.320FNLLS;26.320FNLLW;26.320FNLRC;26.320FNLRS;26.320FNLS;26.320FPLRS;26.320FPLS;26.320FVHLC;26.320FVHL-KO;26.320FVLC;26.320FV-LKO;26.330FNLC;26.330FNLLC;26.330FNLLW;26.350FDC;26.350FDK;26.350FDLC;26.350FDLK;26.350FDLRC;26.350FDLRC-RC;26.350FDLRK;26.350FDLRS;26.350FDLRS/M;26.350FDLRS-RC;26.350FDLS;26.350FDRC;26.350FDRK;26.350FDRS;26.350FDRTM;26.350FDS;26.350FD-TM;26.350FNHLC;26.350FNHLS;26.350FNLC;26.350FNLLC;26.350FNLLRC;26.350FNLLRS;26.350FNLLRW;26.350FNLLS;26.350FNLLW;26.350FNLRC) (4x2 & 6x2 & 6x2/4 & 6x2/2/4 & 6x4 & 6x6 & 8x2/4 & 8x4/4 & 8x4/6 & 8x6/4 & 8x8/4) 04.00-

MERITOR ELSA 1 -
09.01

EFR7648

EFR7649

2911303

**W0400MA1
98024300**

MERITOR D ELSA 2
10.01-03.03

EFR7694

EFR7695

**2913103
CVP088K**

**W0290MA1
98032400**

**DF70001
09.9435.10
FCR214A
93087200**

KNORR SB-SN7
AXIAL (8°+) **03.03-**

EFR7336

EFR7337

**2920200764
2927801
292530539**

**W0400MA
98032000**

KNORR SB-SN7
AXIAL (0°) POTENTIO.
CONTINU VIS **03.03-**

EFR7326

EFR7327

22,5"

AR/R2

KNORR SB-SN7
AXIAL (0°) POTENTIO.
CONTINU VIS **03.03-**

EFR7344

EFR7345

**2920200764
2927801
292530539**

**W0400MA
98032000**

**DF70002
09.9467.10
FCR215A
93087000**

MERITOR ELSA 1 -
09.01

AR/R

EFR7634

EFR7635

2911303

**W0400MA1
98024300**

MERITOR D ELSA 2
10.01-03.03

EFR7716

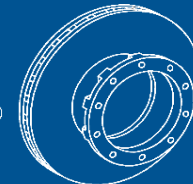
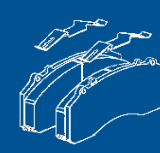
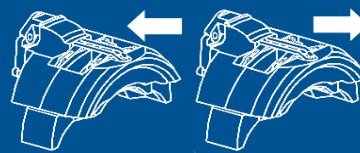
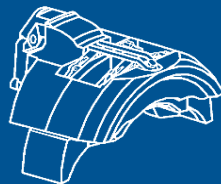
EFR7717

**2913103
CVP088K**

**W0290MA1
98032400**

Automotive

APPLICATION PAR VEHICULES APPLICATION BY VEHICLES



MAN (TRUCKS)/.

TGA
 (26.350FNLS;26.350FNLS;26.350FPHLS;26.350FPLRS;26.350FPLS;26.350FVHLC;26.350FVHL-KO;26.350FVHLS;26.350FVLC;26.350FVL-KO;26.350FVLS;26.360FDC;26.360FDK;26.360FDLC;26.360FDLC-WW;26.360FDLK;26.360FDLRC;26.360FDLRK;26.360FDLRS;26.360FDLRS/M;26.360FDLRSWW;26.360FDLRS-WW;26.360FDLS;26.360FDLS/M;26.360FDRK;26.360FDRS;26.360FDRTM;26.360FDR-TM;26.360FDS;26.360FD-TM;26.360FNHLC;26.360FNHLS;26.360FNLC;26.360FNLLC;26.360FNLLRC;26.360FNLLRS;26.360FNLLRW;26.360FNLLS;26.360FNLLW;26.360FNLRC;26.360FNLS;26.360FNLS;26.360FPHLS;26.360FPLRS;26.360FPLS;26.360FVHLC;26.360FVHL-KO;26.360FVHLS;26.360FVLC;26.360FVL-KO;26.360FVLS;26.360FVLS;26.380FNLLRC;26.380FNLLRC;26.380FPLRS;26.380FPLS;26.390FDC;26.390FDK;26.390FDLC;26.390FDLK;26.390FDLRC;26.390FDLRS;26.390FDLS;26.390FDRK;26.390FDRS;26.390FDS;26.390FDR-TM;26.390FNHLC;26.390FNHLS;26.390FNLC;26.390FNLLC;26.390FNLLRC;26.390FNLLRS;26.390FNLLRW;26.390FNLLS;26.390FNLLW;26.390FNLRC;26.390FNLS;26.390FNLS;26.390FPHLS;26.390FPLRS;26.390FPLS;26.390FVHLC;26.390FVHL-KO;26.390FVHLS;26.390FVLC;26.390FVL-KO;26.390FVLS;26.400FDC;26.400FDK;26.400FDLC;26.400FDLK;26.400FDLRC;26.400FDLRS;26.400FDLS;26.400FDRK;26.400FDRS;26.400FDS;26.400FDR-TM;26.400FNHLC;26.400FNHLS) (4x2 & 6x2 & 6x2/4 & 6x2/2/4 & 6x4 & 6x6 & 8x2/4 & 8x4/4 & 8x4/6 & 8x6/4 & 8x8/4) 04.00-

MERITOR ELSA 1 -
09.01

EFR7648

EFR7649

2911303

**W0400MA1
98024300**

MERITOR D ELSA 2
10.01-03.03

EFR7694

EFR7695

**2913103
CVP088K**

**W0290MA1
98032400**

**DF70001
09.9435.10
FCR214A
93087200**

KNORR SB-SN7
AXIAL (8°+) **03.03-**

EFR7336

EFR7337

2920200764

**W0400MA
98032000**

KNORR SB-SN7
AXIAL (0°) POTENTIO.
CONTINU VIS **03.03-**

EFR7326

EFR7327

**2927801
292530539**

22,5"

AR/R2

KNORR SB-SN7
AXIAL (0°) POTENTIO.
CONTINU VIS **03.03-**

EFR7344

EFR7345

**2920200764
2927801
292530539**

**W0400MA
98032000**

**DF70002
09.9467.10
FCR215A
93087000**

MERITOR ELSA 1 -
09.01

EFR7634

EFR7635

2911303

**W0400MA1
98024300**

AR/R

MERITOR D ELSA 2
10.01-03.03

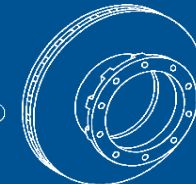
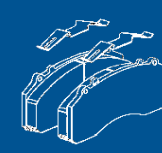
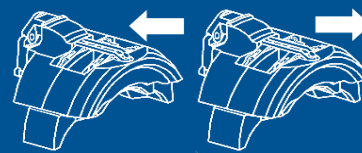
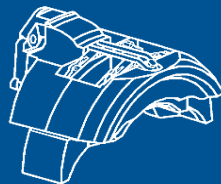
EFR7716

EFR7717

**2913103
CVP088K**

**W0290MA1
98032400**

APPLICATION PAR VEHICULES APPLICATION BY VEHICLES



MAN (TRUCKS) ..!..

TGA

(26.400FNLC;26.400FNLLC;26.400FNLLRC;26.400FNLLRS;26.400FNLLRW;26.400FNLLS;26.400FNLLW;26.400FNLRC;26.400FNLRS;26.400FNLS;26.400FPHLS;26.400FPLRS;26.400FPLS;26.400FVHLC;26.400FVHL-KO;26.400FVHLS;26.400FVLC;26.400FVL-KO;26.400FVLR;26.400FVLS;26.410FDAK;26.410FDALK;26.410FDC;26.410FDK;26.410FDLC;26.410FDLK;26.410FDLRC;26.410FDLRK;26.410FDLRS;26.410FDLS;26.410FDRC;26.410FDRK;26.410FDRS;26.410FDR-TM;26.410FDS;26.410FD-TM;26.410FNLC;26.410FNLLC;26.410FNLLRC;26.410FNLLRW;26.410FNLLS;26.410FNLLW;26.410FNLRC;26.410FNLRS;26.410FNLS;26.410FPLRS;26.410FPLS;26.410FVLC;26.410FVLC-KO;26.410FVLR;26.410FVLS;26.420FNLLRC;26.420FNLRC;26.420FPLRS;26.420FPLS;26.430FDC;26.430FDK;26.430FDLC;26.430FDLK;26.430FDLRC;26.430FDLRS;26.430FDLRS-WW;26.430FDLS;26.430FDLS/M;26.430FDRC;26.430FDRS;26.430FDRTM;26.430FDS;26.430FD-TM;26.430FNHLC;26.430FNHLS;26.430FNLC;26.430FNLLC;26.430FNLLRC;26.430FNLLRS;26.430FNLLS;26.430FNLLW;26.430FNLRC;26.430FNLRS;26.430FNLS;26.430FPHLS;26.430FPLRS;26.430FPLS;26.430FVHLC;26.430FVHLS;26.430FVLC;26.430FVLH-KO;26.430FVL-KO;26.430FVLR;26.430FVLS;26.440FDC;26.440FDK;26.440FDLC;26.440FDLK;26.440FDLRC;26.440FDLRS;26.440FDLS;26.440FDRC;26.440FDRS;26.440FDRTM;26.440FDS;26.440FD-TM;26.440FNHLC;26.440FNHLS) (4x2 & 6x2 & 6x2/4 & 6x2/2/4 & 6x4 & 6x6 & 8x2/4 & 8x4/4 & 8x4/6 & 8X6/4 & 8x8/4) 04.00-

MERITOR ELSA 1 -
09.01

EFR7648

EFR7649

2911303

**W0400MA1
98024300**

MERITOR D ELSA 2
10.01-03.03

EFR7694

EFR7695

**2913103
CVP088K**

**W0290MA1
98032400**

**DF70001
09.9435.10
FCR214A
93087200**

AV/F

KNORR SB-SN7
AXIAL (8°+) **03.03-**

EFR7336

EFR7337

**2920200764
2927801
292530539**

**W0400MA
98032000**

KNORR SB-SN7
AXIAL (0°) POTENTIO.
CONTINU VIS **03.03-**

EFR7326

EFR7327

22,5"

AR/R2

KNORR SB-SN7
AXIAL (0°) POTENTIO.
CONTINU VIS **03.03-**

EFR7344

EFR7345

**2920200764
2927801
292530539**

**W0400MA
98032000**

**DF70002
09.9467.10
FCR215A
93087000**

MERITOR ELSA 1 -
09.01

AR/R

EFR7634

EFR7635

2911303

**W0400MA1
98024300**

MERITOR D ELSA 2
10.01-03.03

EFR7716

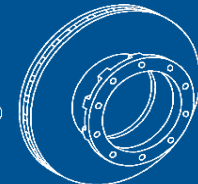
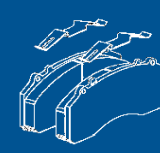
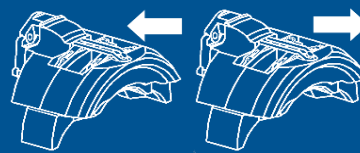
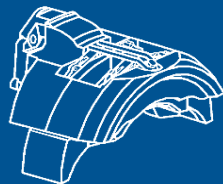
EFR7717

**2913103
CVP088K**

**W0290MA1
98032400**

Automotive

APPLICATION PAR VEHICULES
APPLICATION BY VEHICLES



MAN (TRUCKS)/.

TGA
(26.440FNLC;26.440FNLLC;26.440FNLLRC;26.440FNLLRS;26.440FNLLS;26.440FNLLW;26.440FNLRC;26.440FNLRS;26.440FNLS;26.440FPHLS;26.440FPLRS;26.440FPLS;26.440FVHLC;26.440FVHLS;26.440FVLC;26.440FVLH-KO;26.440FVL-KO;26.440FVLR;26.440FVLS;26.460FDC;26.460FDK;26.460FDLC;26.460FDLK;26.460FDLRC;26.460FDLRK;26.460FDLRS;26.460FDLS;26.460FDRC;26.460FDRK;26.460FDRS;26.460FDR-TM;26.460FDS;26.460FD-TM;26.460FNLC;26.460FNLLC;26.460FNLLRC;26.460FNLLRW;26.460FNLLS;26.460FNLLW;26.460FNLRC;26.460FNLRS;26.460FNLS;26.460FPLRS;26.460FPLS;26.460FVLC;26.460FVLC-KO;26.460FVLR;26.460FVLS;26.480FDC;26.480FDK;26.480FDLC;26.480FDLK;26.480FDLRC;26.480FDLRK;26.480FDLRS;26.480FDLS;26.480FDRC;26.480FDRS;26.480FDS;26.480FD-TM;26.480FNHLC;26.480FNHLS;26.480FNLC;26.480FNLLC;26.480FNLLRC;26.480FNLLS;26.480FNLLW;26.480FNLRC;26.480FNLRS;26.480FNLS;26.480FPHLS;26.480FPLS;26.480FVHLC;26.480FVHLS;26.480FVLC;26.480FVLC-KO;26.480FVLR;26.480FVLS;26.510FDC;26.510FDLC;26.510FDLRC;26.510FDLRS;26.510FDLS;26.510FDLS/M;26.510FDRC;26.510FDRS;26.510FDS;26.510FNLC;26.510FNLLC;26.510FNLLRC;26.510FNLLRW;26.510FNLLS;26.510FNLLW;26.510FNLRC;26.510FNLRS;26.510FNLS;26.510FPLS;26.510FVLC;26.510FVLR;26.510FVLS;26.530FDC;26.530FDK;26.530FDLC) (4x2 & 6x2 & 6x2/4 & 6x2/2/4 & 6x4 & 6x6 & 8x2/4 & 8x4/4 & 8x4/6 & 8X6/4 & 8x8/4) 04.00-

MERITOR ELSA 1 -
09.01

EFR7648

EFR7649

2911303

**W0400MA1
98024300**

MERITOR D ELSA 2
10.01-03.03

EFR7694

EFR7695

**2913103
CVP088K**

**W0290MA1
98032400**

**DF70001
09.9435.10
FCR214A
93087200**

KNORR SB-SN7
AXIAL (8°+) **03.03-**

AV/F

EFR7336

EFR7337

**2920200764
2927801
292530539**

**W0400MA
98032000**

KNORR SB-SN7
AXIAL (0°) POTENTIO.
CONTINU VIS **03.03-**

EFR7326

EFR7327

22,5" KNORR SB-SN7
AXIAL (0°) POTENTIO.
CONTINU VIS **03.03-**

AR/R2

EFR7344

EFR7345

**2920200764
2927801
292530539**

**W0400MA
98032000**

**DF70002
09.9467.10
FCR215A
93087000**

MERITOR ELSA 1 -
09.01

AR/R

EFR7634

EFR7635

2911303

**W0400MA1
98024300**

MERITOR D ELSA 2
10.01-03.03

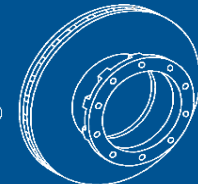
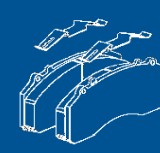
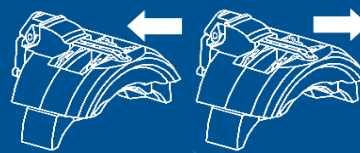
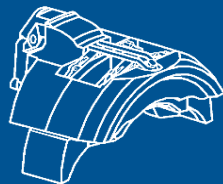
EFR7716

EFR7717

**2913103
CVP088K**

**W0290MA1
98032400**

APPLICATION PAR VEHICULES APPLICATION BY VEHICLES



MAN (TRUCKS) ..I..

TGA

(26.530FDLK;26.530FDLRC;26.530FDLRK;26.530FDLRS;26.530FDLS;26.530FDRC;26.530FDRS;26.530FDS;26.530FNLC;26.530FNLLC;26.530FNLLRC;26.530FNLLRW;26.530FNLLS;26.530FNLLW;26.530FNLRC;26.530FNLRS;26.530FNLS;26.530FPLS;26.530FVLC;26.530FVLRC;26.530FVLS;26.530FVLS;26.540FNLC;26.540FNLLC;26.540FNLLRC;26.540FNLLW;26.540FNLRC;27.440FDLRS;27.440FDLS;27.440FDRS;27.440FDS;28.310FNLC;28.310FNLLC;28.310FNLL-LE;28.310FNLLR-LE;28.310FNLRC;28.310FNLRS;28.310FNLS;28.320FNLC;28.320FNLLC;28.320FNLL-LE;28.320FNLLRC;28.320FNLLR-LE;28.320FNLRC;28.320FNLRS;28.320FNLS;28.350FANLC;28.350FANLK;28.350FNLC;28.350FNLLC;28.350FNLL-LE;28.350FNLLR-LE;28.350FNLRC;28.350FNLRS;28.350FNLS;28.360FANLC;28.360FANLK;28.360FNLC;28.360FNLLC;28.360FNLL-LE;28.360FNLLR-LE;28.360FNLRC;28.360FNLRS;28.360FNLS;28.390FANLC;28.390FANLK;28.390FNLC;28.390FNLLC;28.390FNLRC;28.390FNLRS;28.390FNLS;28.400FANLC;28.400FANLK;28.400FNLC;28.400FNLLC;28.400FNLRC;28.400FNLRS;28.400FNLS;28.410FANLC;28.410FANLK;28.410FNLC;28.410FNLLC;28.410FNLRC;28.410FNLRS;28.410FNLS;28.430FANLC;28.430FANLK;28.430FNLC;28.430FNLLC;28.430FNLRC;28.430FNLRS;28.430FNLS;28.440FANLC;28.440FANLK;28.440FNLC;28.440FNLLC;28.440FNLRC;28.440FNLRS;28.440FNLS;28.460FNLC;28.460FNLLC;28.460FNLRC;28.460FNLRS;28.460FNLS)
(4x2 & 6x2 & 6x2/4 & 6x2/2/4 & 6x4 & 6x6 & 8x2/4 & 8x4/4 & 8x4/6 & 8X6/4 & 8x8/4) 04.00-

MERITOR ELSA 1 -
09.01

EFR7648

EFR7649

2911303

**W0400MA1
98024300**

MERITOR D ELSA 2
10.01-03.03

EFR7694

EFR7695

**2913103
CVP088K**

**W0290MA1
98032400**

**DF70001
09.9435.10
FCR214A
93087200**

AV/F

KNORR SB-SN7
AXIAL (8°+) **03.03-**

EFR7336

EFR7337

**2920200764
2927801
292530539**

**W0400MA
98032000**

KNORR SB-SN7
AXIAL (0°) POTENTIO.
CONTINU VIS **03.03-**

EFR7326

EFR7327

22,5"

AR/R2

KNORR SB-SN7
AXIAL (0°) POTENTIO.
CONTINU VIS **03.03-**

EFR7344

EFR7345

**2920200764
2927801
292530539**

**W0400MA
98032000**

**DF70002
09.9467.10
FCR215A
93087000**

MERITOR ELSA 1 -
09.01

EFR7634

EFR7635

2911303

**W0400MA1
98024300**

AR/R

MERITOR D ELSA 2
10.01-03.03

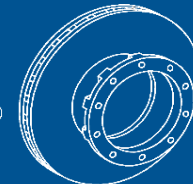
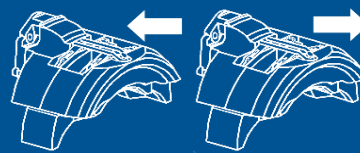
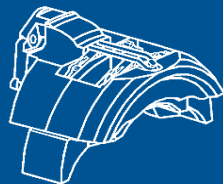
EFR7716

EFR7717

**2913103
CVP088K**

**W0290MA1
98032400**

APPLICATION PAR VEHICULES APPLICATION BY VEHICLES



MAN (TRUCKS)/

TGA

(28.480FANLC;28.480FANLK;28.480FNLC;28.480FNLLC;28.480FNLRC;28.480FNLRS;28.480FNLS;28.510FNLC;28.510FNLLC;28.510FNLRC;28.510FNLRS;28.510FNLS;28.530FANLC;28.530FANLK;28.530FNLC;28.530FNLLC;28.530FNLRC;28.530FNLRS;28.530FNLS;28.540FNLC;28.540FNLLC;28.540FNLS;32.310FFDC;32.310FFDK;32.310FFDLC;32.310FFDLK;32.310FFDLRC;32.310FFDRC;32.310FFDR-TM;32.310FFD-TM;32.350FFDC;32.350FFDLC;32.350FFDLRC;32.350FFDR C;32.350FFDR-TM;32.350FFD-TM;32.360FFDC;32.360FFDK;32.360FFDLC;32.360FFDLK;32.360FFDLRC;32.360FFDRC;32.360FFDR-TM;32.360FFD-TM;32.360FFDR-TM;32.390FFDRC;32.390FFDR-TM;32.390FFD-TM;32.400FFDRC;32.400FFDR-TM;32.400FFD-TM;32.410FFDC;32.410FFDK;32.410FFDLC;32.410FFDLK;32.410FFDLRC;32.410FFDRC;32.410FFDR-TM;32.410FFD-TM;32.430FFDRC;32.430FFDR-TM;32.430FFD-TM;32.440FFDRC;32.440FFDR-TM;32.440FFD-TM;32.460FFDC;32.460FFDK;32.460FFDLC;32.460FFDLK;32.460FFDLRC;32.460FFDRC;32.460FFDR-TM;32.460FFD-TM;32.480FFDC;32.480FFDK;32.480FFDLC;32.480FFDLK;32.480FFDLRC;32.480FFDRC;32.480FFDR-TM;32.480FFD-TM;33.350FDAC;33.350FDAK;33.350FDARC;33.350FDARK;33.350FDARS;33.350FDAS;33.350FDC;33.350FDC-TM;33.350FDHC;33.350FDHK;33.350FDHS;33.350FDK;33.350FDLC;33.350FDLK;33.350FDLRS;33.350FDLS;33.350FDRC;33.350FDR-;33.350FDRK;33.350FDRS;33.350FDS;33.360FDAC;33.360FDAK) (4x2 & 6x2 & 6x2/4 & 6x2/2/4 & 6x4 & 6x6 & 8x2/4 & 8x4/4 & 8x4/6 & 8X6/4 & 8x8/4) 04.00-

MERITOR ELSA 1 -
09.01

EFR7648

EFR7649

2911303

**W0400MA1
98024300**

MERITOR D ELSA 2
10.01-03.03

EFR7694

EFR7695

**2913103
CVP088K**

**W0290MA1
98032400**

**DF70001
09.9435.10
FCR214A
93087200**

KNORR SB-SN7 AV/F
AXIAL (8°+) **03.03-**

EFR7336

EFR7337

**2920200764
2927801**

**W0400MA
98032000**

KNORR SB-SN7
AXIAL (0°) POTENTIO.
CONTINU VIS **03.03-**

EFR7326

EFR7327

292530539

22,5" KNORR SB-SN7 AR/R2
AXIAL (0°) POTENTIO.
CONTINU VIS **03.03-**

EFR7344

EFR7345

**2920200764
2927801
292530539**

**W0400MA
98032000**

MERITOR ELSA 1 -
09.01

EFR7634

EFR7635

2911303

**W0400MA1
98024300**

**DF70002
09.9467.10
FCR215A
93087000**

MERITOR D ELSA 2
10.01-03.03

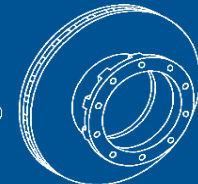
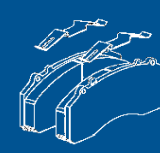
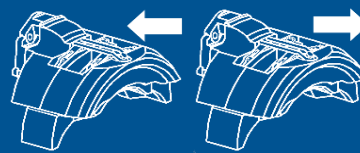
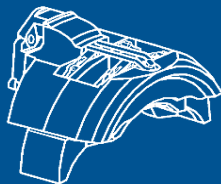
EFR7716

EFR7717

**2913103
CVP088K**

**W0290MA1
98032400**

APPLICATION PAR VEHICULES APPLICATION BY VEHICLES



MAN (TRUCKS) ..!..

TGA

(33.360FDARC;33.360FDARK;33.360FDARS;33.360FDAS;33.360FDC;33.360FDCTM;33.360FDC-TM;33.360FDHC;33.360FDHK;33.360FDHS;33.360FDK;33.360FDK-WW;33.360FDLC;33.360FDLK;33.360FDLRC;33.360FDLRS;33.360FDLS;33.360FDRC;33.360FDRC-TM;33.360FDRK;33.360FDRK-WW;33.360FDRS;33.360FDR-TM;33.360FDS;33.360FDTM;33.390FDC;33.390FDC-TM;33.390FDK;33.390FDLC;33.390FDLK;33.390FDLRC;33.390FDLRS;33.390FDLS;33.390FDRC;33.390FDRC-TM;33.390FDRK;33.390FDRS;33.390FDS;33.400FDC;33.400FDC-TM;33.400FDK;33.400FDLC;33.400FDLK;33.400FDLRC;33.400FDLRS;33.400FDLS;33.400FDRC;33.400FDRC-TM;33.400FDRK;33.400FDRS;33.400FDS;33.410FDC;33.410FDK;33.410FDK-WW;33.410FDLC;33.410FDLK;33.410FDLRC;33.410FDLRS;33.410FDLS;33.410FDRC;33.410FDRK-WW;33.410FDRS;33.410FDR-TM;33.410FDS;33.410FD-TM;33.430FDC;33.430FDC-TM;33.430FDK;33.430FDLC;33.430FDLK;33.430FDLRC;33.430FDLRS;33.430FDLS;33.430FDRC;33.430FDRC-TM;33.430FDRK;33.430FDRS;33.430FDS;33.440FDC;33.440FDC-TM;33.440FDK;33.440FDLC;33.440FDLK;33.440FDLRC;33.440FDLRS;33.440FDLS;33.440FDRC;33.440FDRC-TM;33.440FDRK;33.440FDRS;33.440FDS;33.460FDC;33.460FDK;33.460FDLC;33.460FDLK;33.460FDLRC;33.460FDLRS;33.460FDLS;33.460FDRC;33.460FDRK;33.460FDRS;33.460FDR-TM;33.460FDS;33.460FD-TM) (4x2 & 6x2 & 6x2/4 & 6x2/2/4 & 6x4 & 6x6 & 8x2/4 & 8x4/4 & 8x4/6 & 8X6/4 & 8x8/4) 04.00-

MERITOR ELSA 1 -
09.01

EFR7648

EFR7649

2911303

**W0400MA1
98024300**

MERITOR D ELSA 2
10.01-03.03

EFR7694

EFR7695

**2913103
CVP088K**

**W0290MA1
98032400**

**DF70001
09.9435.10
FCR214A
93087200**

KNORR SB-SN7
AXIAL (8°+) **03.03-**

EFR7336

EFR7337

**2920200764
2927801
292530539**

**W0400MA
98032000**

KNORR SB-SN7
AXIAL (0°) POTENTIO.
CONTINU VIS **03.03-**

EFR7326

EFR7327

22,5"

KNORR SB-SN7
AXIAL (0°) POTENTIO.
CONTINU VIS **03.03-**

EFR7344

EFR7345

**2920200764
2927801
292530539**

**W0400MA
98032000**

**DF70002
09.9467.10
FCR215A
93087000**

MERITOR ELSA 1 -
09.01

EFR7634

EFR7635

2911303

**W0400MA1
98024300**

MERITOR D ELSA 2
10.01-03.03

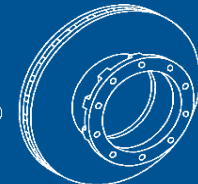
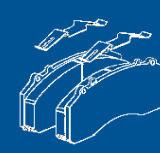
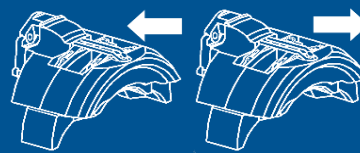
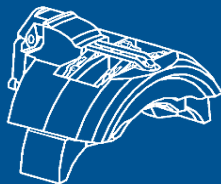
EFR7716

EFR7717

**2913103
CVP088K**

**W0290MA1
98032400**

APPLICATION PAR VEHICULES APPLICATION BY VEHICLES



MAN (TRUCKS)/.

TGA (33.480FDC;33.480FDC-

TM;33.480FDK;33.480FDLC;33.480FDLK;33.480FDLRC;33.480FDLRS;33.480FDLS;33.480FDRC;33.480FDRK;33.480FDRS;33.480FDS;33.480FD-

TM;33.510FDC;33.510FDLC;33.510FDLRC;33.510FDLRS;33.510FDLS;33.510FDRC;33.510FDRS;33.510FDS;33.530FDC;

33.530FDK;33.530FDLC;33.530FDLK;33.530FDLRC;33.530FDLRS;33.530FDLS;33.530FDRC;33.530FDRS;33.530FDS;35.310FFDC;35.310FFDK;35.310FFDLC;35.310FFDLK;35.310FF-

FD-

TM;35.320FFDC;35.320FFDK;35.320FFDLC;35.320FFDLK;35.320FFD-

TM;35.350FFDC;35.350FFDHC;35.350FFDHLK;35.350FFDH-

TM;35.350FFDK;35.350FFDLC;35.350FFDLK;35.350FFDRC;

35.350FFDRK;35.350FFD-

TM;35.350FFNLC;35.360FFDAK;35.360FFDC;35.360FFDHC;

35.360FFDHLK;35.360FFDH-

TM;35.360FFDK;35.360FFDLC;35.360FFDLK;35.360FFDRC;

35.360FFDRK;35.360FFD-

TM;35.360FFNLC;35.360FFNLC;35.390FDNLC;35.390FFD-

AK;35.390FFDC;35.390FFDHC;35.390FFDHLK;35.390FFDH-

TM;35.390FFDK;35.390FFDLC;35.390FFDLK;35.390FFDRC;

35.390FFDRK;35.390FFD-

TM;35.400FDNLC;35.400FFDAK;35.400FFDC;

35.400FFDHC;35.400FFDHLK;35.400FFDH-

TM;35.400FFDK;35.400FFDLC;35.400FFDLK;35.400FFDRC;

35.400FFDRK;35.400FFD-

TM;35.400FFNLC;35.400FFNLC;35.410FDNLC;35.410FFD-

AK;35.410FFDC;35.410FFDK;35.410FFDLC;35.410FFDLK;35.410FFD-

TM;35.410FFNLC;35.430FDNLC;35.430FFDAK;35.430FFDC)

(4x2 & 6x2 & 6x2/4 & 6x2/2/4 & 6x4 & 6x6 & 8x2/4 & 8x4/4 & 8x4/6 & 8x6/4 & 8x8/4) 04.00-

MERITOR ELSA 1 -
09.01

EFR7648

EFR7649

2911303

**W0400MA1
98024300**

MERITOR D ELSA 2
10.01-03.03

EFR7694

EFR7695

**2913103
CVP088K**

**W0290MA1
98032400**

**DF70001
09.9435.10
FCR214A
93087200**

AV/F

KNORR SB-SN7
AXIAL (8°+) **03.03-**

EFR7336

EFR7337

**2920200764
2927801
292530539**

**W0400MA
98032000**

22,5"

KNORR SB-SN7
AXIAL (0°) POTENTIO.
CONTINU VIS **03.03-**

EFR7326

EFR7327

AR/R2

KNORR SB-SN7
AXIAL (0°) POTENTIO.
CONTINU VIS **03.03-**

EFR7344

EFR7345

**2920200764
2927801
292530539**

**W0400MA
98032000**

AR/R

MERITOR ELSA 1 -
09.01

EFR7634

EFR7635

2911303

**W0400MA1
98024300**

AR/R

MERITOR D ELSA 2
10.01-03.03

EFR7716

EFR7717

**2913103
CVP088K**

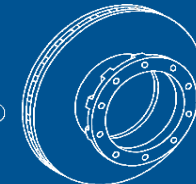
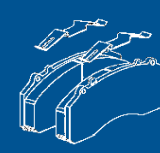
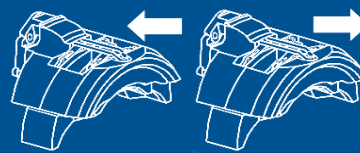
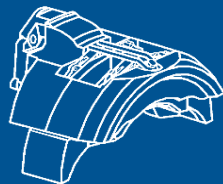
**W0290MA1
98032400**

AR/R

**DF70002
09.9467.10
FCR215A
93087000**

Automotive

APPLICATION PAR VEHICULES APPLICATION BY VEHICLES



MAN (TRUCKS) ..

TGA (35.430FFDHK;35.430FFDHLK;35.430FFDH-TM;35.430FFDK;35.430FFDLC;35.430FFDLK;35.430FFDRC;35.430FFDRK;35.430FFD-TM;35.430FFNLC;35.440FDNLC;35.440FFDAK;35.440FFDC;35.440FFDHK;35.440FFDHLK;35.440FFDH-TM;35.440FFDK;35.440FFDLC;35.440FFDLK;35.440FFDRC;35.440FFDRK;35.440FFD-TM;35.440FFNHLC;35.440FFNLC;35.460FFDC;35.460FFDK;35.460FFDLC;35.460FFDLK;35.460FFD-TM;35.460FFNLC;35.480FDNLC;35.480FFDAK;35.480FFDARS;35.480FFDC;35.480FFDHK;35.480FFDHLK;35.480FFDH-TM;35.480FFDK;35.480FFDLC;35.480FFDLK;35.480FFD-TM;35.480FFNHLC;35.480FFNLC;35.530FDNLC;35.530FFDAK;35.530FFDC;35.530FFDK;35.530FFDLC;35.530FFDLK;35.530FFD-TM;35.530FFNLC;37.310FFDC;37.310FFDK;37.310FFD-TM;37.320FFDC;37.320FFDK;37.320FFD-TM;37.350FFDC;37.350FFDK;37.350FFD-TM;37.360FFDC;37.360FFDK;37.360FFD-TM;37.390FFDC;37.390FFDK;37.390FFD-TM;37.400FFDC;37.400FFDK;37.400FFD-TM;37.410FFDC;37.410FFDK;37.410FFD-TM;37.430FFDC;37.430FFDK;37.430FFD-TM;37.440FFDC;37.440FFDK;37.440FFD-TM;37.460FFDC;37.460FFDK;37.460FFD-TM;37.480FFDC;37.480FFDK;37.480FFD-TM;37.530FFDC;37.530FFDK;37.530FFD-TM;37.530FVDLS;37.530FVDS;39.390FVNLC;39.400FVNLC;39.430FVNLC;39.440FVNLC;39.480FVNLC;40.390FDK;40.390FDRK;40.390FDRS;40.390FDS;40.400FDK;40.400FDRK;40.400FDRS;40.400FDS;40.410FDK;40.410FDS) (4x2 & 6x2 & 6x2/4 & 6x2/2/4 & 6x4 & 6x6 & 8x2/4 & 8x4/4 & 8x4/6 & 8X6/4 & 8x8/4) 04.00-

MERITOR ELSA 1 -
09.01

EFR7648

EFR7649

2911303

**W0400MA1
98024300**

MERITOR D ELSA 2
10.01-03.03

EFR7694

EFR7695

**2913103
CVP088K**

**W0290MA1
98032400**

**DF70001
09.9435.10
FCR214A
93087200**

KNORR SB-SN7
AXIAL (8°+) **03.03-**

AV/F

EFR7336

EFR7337

**2920200764
2927801
292530539**

**W0400MA
98032000**

KNORR SB-SN7
AXIAL (0°) POTENTIO.
CONTINU VIS **03.03-**

EFR7326

EFR7327

22,5"

AR/R2

KNORR SB-SN7
AXIAL (0°) POTENTIO.
CONTINU VIS **03.03-**

EFR7344

EFR7345

**2920200764
2927801
292530539**

**W0400MA
98032000**

**DF70002
09.9467.10
FCR215A
93087000**

MERITOR ELSA 1 -
09.01

AR/R

EFR7634

EFR7635

2911303

**W0400MA1
98024300**

MERITOR D ELSA 2
10.01-03.03

EFR7716

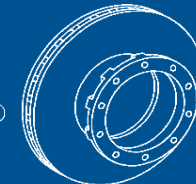
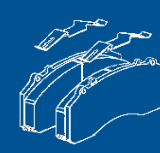
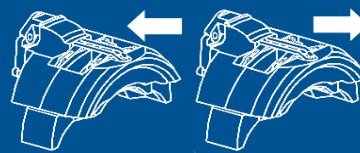
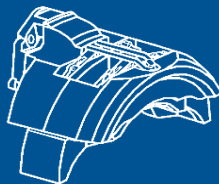
EFR7717

**2913103
CVP088K**

**W0290MA1
98032400**

Automotive

APPLICATION PAR VEHICULES APPLICATION BY VEHICLES



MAN (TRUCKS) ..!..

TGA

(40.430FDK;40.430FDRK;40.430FDRS;40.430FDS;40.440FDK;40.440FDRK;
40.440FDRS;40.440FDS;40.460FDK;40.460FDS;40.480FDK;40.480FDRK;4
0.480FDRS;40.480FDS;41.350FFD;41.350FFDC;41.350FFDC-
TM;41.350FFDK;41.350FFDRC;41.350FFDRC-TM;41.350FFDRK;41.350FFD-
TM;41.360FDRK;
TM;41.360FFD;41.360FFDC;41.360FFDC/M;41.360FFDC/M-
WW;41.360FFDC-
TM;41.360FFDK;41.360FFDRC;41.360FFDRC-TM;41.360FFDRC-
TM;41.360FFDRK;41.360FFD-TM;41.390FDRK;
TM;41.390FFD;41.390FFDAK;41.390FFDC;41.390FFDC-
TM;41.390FFDK;41.390FFDRC;41.390FFDRC-TM;41.390FFDRK;41.390FFD-
TM;41.400FDRK;41.400FFD;41.400FFDC;41.400FFDC-
TM;41.400FFDK;41.400FFDRC;41.400FFDRC-TM;41.400FFDRK;41.400FFD-
TM;41.410FDRK;41.410FFD;41.410FFDC;41.410FFDC-
TM;41.410FFDK;41.410FFDRC;41.410FFDRC-TM;41.410FFDRK;41.410FFD-
TM;41.430FFD;41.430FFDAK;41.430FFDC;41.430FFDC-
TM;41.430FFDK;41.430FFDRC;41.430FFDRC-TM;41.430FFDRK;41.430FFD-
TM;41.440FFD;41.440FFD/M;41.440FFDAK;41.440FFDC;41.440FFDC-
TM;41.440FFDK;41.440FFDRC;41.440FFDRC-TM;41.440FFDRC-
TM;41.440FFDRK;41.440FFD-TM;41.460FFDC;41.460FFDC-
TM;41.460FFDK;41.460FFDRC;41.460FFDRC-TM;41.460FFDRK;41.460FFD-
TM;41.480FFD;41.480FFDAK;41.480FFDARC;41.480FFDC;41.480FFDC-
TM;41.480FFDK;41.480FFDRC;41.480FFDRC-TM;41.480FFDRC-
TM;41.480FFDRK;41.480FFD-
TM;41.480FVDLS;41.480FVDS;41.530FFDAK;41.530FFDC;41.530FFDC-
TM;41.530FFDK;41.530FFDRC-TM;41.530FFDRK;41.530FFD-
TM;41.530FVDLS;41.530FVDS;41.540FVDLS;41.540FVDS;41.660FVDLS;41
.660FVDS) (4x2 & 6x2 & 6x2/4 & 6x2/2/4 & 6x4 & 6x6 & 8x2/4 &
8x4/4 & 8x4/6 & 8X6/4 & 8x8/4) 04.00-

MERITOR ELSA 1 -
09.01

EFR7648

EFR7649

2911303

**W0400MA1
98024300**

MERITOR D ELSA 2
10.01-03.03

EFR7694

EFR7695

**2913103
CVP088K**

**W0290MA1
98032400**

KNORR SB-SN7
AXIAL (8°+) **03.03-** AV/F

EFR7336

EFR7337

**2920200764
2927801
292530539**

**W0400MA
98032000**

**DF70001
09.9435.10
FCR214A
93087200**

KNORR SB-SN7
AXIAL (0°) POTENTIO.
CONTINU VIS **03.03-**

EFR7326

EFR7327

22,5"

AR/R2

KNORR SB-SN7
AXIAL (0°) POTENTIO.
CONTINU VIS **03.03-**

EFR7344

EFR7345

**2920200764
2927801
292530539**

**W0400MA
98032000**

**DF70002
09.9467.10
FCR215A
93087000**

MERITOR ELSA 1 -
09.01 AR/R

EFR7634

EFR7635

2911303

**W0400MA1
98024300**

MERITOR D ELSA 2
10.01-03.03

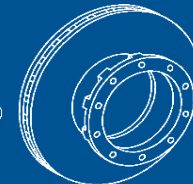
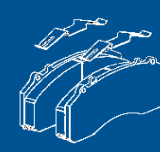
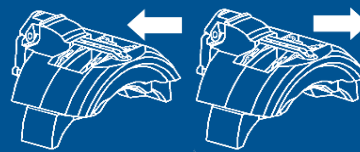
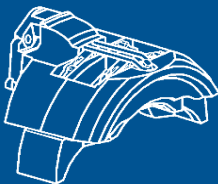
EFR7716

EFR7717

**2913103
CVP088K**

**W0290MA1
98032400**

APPLICATION PAR VEHICULES APPLICATION BY VEHICLES



MAN (TRUCKS)/.

TGM (12.240FLC; 12.240FLLC; 12.280FC; 12.280FLC; 12.280FLLC) (4x2 & 4x4) 10.05-

19,5" KNORR SB-SN6
AXIAL (5°+)

AV/F
AR/R

EFR6300

EFR6301

2932003
CVP036K

W0400MA
98032000

FCR331A
93191200

TGM (13.240FAEC; 13.240FAERC; 13.240FAL; 13.240FALC; 13.240FALK; 13.240FALKL; 13.240FAL-LF; 13.240FALRC; 13.240FALRK; 13.240FALRK-L; 13.240FALR-LF; 13.240FFALR; 13.250FAL-LF; 13.250FALR-LF; 13.280FAEC; 13.280FAERC; 13.280FAL; 13.280FALK; 13.280FALKL; 13.280FAL-LF; 13.280FALRC; 13.280FALRK; 13.280FALRK-L; 13.280FALR-LF; 13.280FFALC; 13.290FAL-LF; 13.290FALR-LF) (4x2 & 4x4) 10.05-

19,5" KNORR SB-SN6
AXIAL (5°+)

AV/F

EFR6300

EFR6301

TM
2932003
CVP036K

W0400MA
98032000

09.A461.10
FCR147A
93086900

TGM (12.250FLC; 12.250FLLC; 12.290FLC; 12.290FLLC; 13.250FAEC; 13.250FAERC; 13.250FAL; 13.250FALC; 13.250FALK; 13.250FALR; 13.250FALRC; 13.250FALRK; 13.250FFALKL; 13.250FFALRK-L; 13.290FAEC; 13.290FAERC; 13.290FAL; 13.290FALC; 13.290FALK; 13.290FALKL; 13.290FALR; 13.290FALRC; 13.290FALRK; 13.290FALRK-L; 15.240FC; 15.240FLC; 15.240FLK; 15.240FLLC; 15.240FLLRC; 15.240FLRC; 15.240FLRK; 15.250FC; 15.250FK; 15.250FK-L; 15.250FLC; 15.250FLK; 15.250FLK-L; 15.250FLLC; 15.250FLLRC; 15.250FLRC; 15.250FLRK; 15.280FC; 15.280FLC; 15.280FLK; 15.280FLLC; 15.280FLLRC; 15.280FLRC; 15.280FLRK; 15.290FC; 15.290FK; 15.290FK-L; 15.290FLC; 15.290FLK; 15.290FLK-L; 15.290FLLC; 15.290FLLRC; 15.290FLRC; 15.290FLRK; 15.330FC; 15.330FLC; 15.330FLK; 15.330FLRC; 15.330FLRK; 15.340FC; 15.340FK; 15.340FK-L; 15.340FLC; 15.340FLK; 15.340FLK-L; 15.340FLRC; 15.340FLRK) (4x2 & 4x4 & 6x2/4 & 6x4) 10.05-

KNORR SB-SN7
22,5" AXIAL (0°) POTENTIO.
CONTINU VIS

AV/F

EFR7326

EFR7327

2920200764
2927801
292530539

DF70001
09.9435.10
FCR214A
93087200

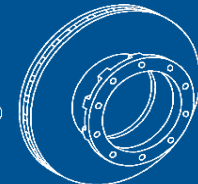
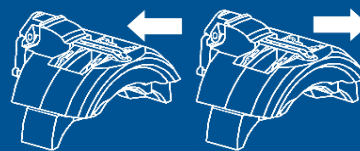
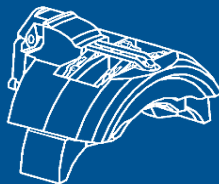
AR/R

EFR7345

EFR7344

DF70002
09.9467.10
FCR215A
93087000

APPLICATION PAR VEHICULES
APPLICATION BY VEHICLES



MAN (TRUCKS) ..!

TGM (18.240FAC; 18.240FAK; 18.240FAK-L;
18.240FARC; 18.240FARK; 18.240FARK-L; 18.240FC;
18.240FK; 18.240FK-L; 18.240FLC; 18.240FLK;
18.240FLK-L; 18.240FLLC; 18.240FLLRC; 18.240FLRC;
18.240FLRK; 18.240FLRK-L; 18.240FRC; 18.240FRK;
18.240FRK-L; 18.250FAC; 18.250FAK; 18.250FAK-L;
18.250FARC; 18.250FARK; 18.250FARK-L; 18.250FC;
18.250FK; 18.250FK-L; 18.250FLC; 18.250FLK;
18.250FLK-L; 18.250FLLC; 18.250FLLRC; 18.250FLRC;
18.250FLRK; 18.250FLRK-L; 18.250FRC; 18.250FRK;
18.250FRK-L; 18.280FAC; 18.280FAK; 18.280FAK-L;
18.280FARC; 18.280FARK; 18.280FARK-L; 18.280FC;
18.280FK; 18.280FK-L; 18.280FLC; 18.280FLK;
18.280FLK-L; 18.280FLLC; 18.280FLLRC; 18.280FLRC;
18.280FLRK; 18.280FLRK-L; 18.280FRC; 18.280FRK;
18.280FRK-L; 18.290FAC; 18.290FAK; 18.290FAK-L;
18.290FARC; 18.290FARK; 18.290FARK-L; 18.290FC;
18.290FK; 18.290FK-L; 18.290FLC; 18.290FLK;
18.290FLK-L; 18.290FLLC; 18.290FLLRC; 18.290FLRC;
18.290FLRK; 18.290FLRK-L; 18.290FRC; 18.290FRK;
18.290FRK-L) (4x2 & 4x4 & 6x2/4 & 6x4) 10.05-

KNORR SB-SN7
22,5" AXIAL (0°) POTENTIO.
CONTINU VIS

AV/F

EFR7326

EFR7327

AR/R

EFR7345

EFR7344

TM

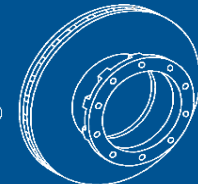
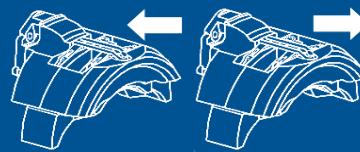
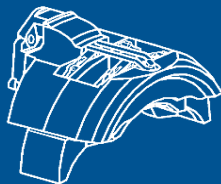
DF70001
09.9435.10
FCR214A
93087200

2920200764
2927801
292530539

DF70002
09.9467.10
FCR215A
93087000

Automotive

APPLICATION PAR VEHICULES APPLICATION BY VEHICLES



MAN (TRUCKS) ..!

TGM (18.290FRK-L; 18.330FAC; 18.330FAK; 18.330FAK-L;
18.330FARC; 18.330FARK; 18.330FARK-L; 18.330FC; 18.330FFRK;
18.330FK; 18.330FK-L; 18.330FLC; 18.330FLK; 18.330FLK-L;
18.330FLLC; 18.330FLLRC; 18.330FLRC; 18.330FLRK;
18.330FLRK-L; 18.330FRC; 18.330FRK-L; 18.340FAC; 18.340FAK;
18.340FAK-L; 18.340FARC; 18.340FARK; 18.340FARK-L;
18.340FC; 18.340FK; 18.340FK-L; 18.340FLC; 18.340FLK;
18.340FLK-L; 18.340FLLC; 18.340FLLRC; 18.340FLRC;
18.340FLRK; 18.340FLRK-L; 18.340FRC; 18.340FRK; 18.340FRK-
L) (4x2 & 4x4 & 6x2/4 & 6x4) 10.05-

22,5"

KNORR SB-SN7
AXIAL (0°) POTENTIO.
CONTINU VIS

AV/F

EFR7326

EFR7327

292000764
2927801
292530539

DF70001
09.9435.10
FCR214A
93087200

AR/R

EFR7345

EFR7344

DF70002
09.9467.10
FCR215A
93087000

TGM (22.240FNLLC; 22.250FNLLC; 22.280FNLC;
22.280FNLLC; 22.280FNLLRC; 22.280FNLRC;
22.290FNLC; 22.290FNLLC; 26.280FD; 26.280FDK-HK;
26.280FD-TM; 26.280FFDRK-HK; 26.280FFDR-TM;
26.280FNLC; 26.280FNLLC; 26.280FNLLRC;
26.280FNLRC; 26.290FD; 26.290FDK-HK; 26.290FDR;
26.290FDR-TM; 26.290FD-TM; 26.290FFDRK-HK;
26.290FNLC; 26.290FNLLC; 26.290FNLLRC;
26.290FNLRC; 26.290FVL; 26.330FD; 26.330FDK-HK;
26.330FDR; 26.330FDRK-HK; 26.330FDR-TM;
26.330FD-TM; 26.330FFNLLRC; 26.330FNLC;
26.330FNLLC; 26.330FNLRC; 26.330FVL; 26.340FD;
26.340FDK-HK; 26.340FDR; 26.340FDRK-HK;
26.340FDR-TM; 26.340FD-TM; 26.340FNLC;
26.340FNLLC; 26.340FNLLRC; 26.340FNLRC) (4x2 &
4x4 & 6x2/4 & 6x4) 10.05-

22,5"

KNORR SB-SN7
AXIAL (0°) POTENTIO.
CONTINU VIS

AV/F

EFR7326

EFR7327

292000764
2927801
292530539

DF70001
09.9435.10
FCR214A
93087200

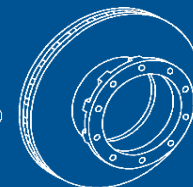
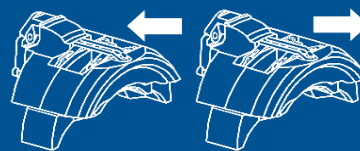
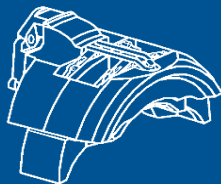
AR/R

EFR7345

EFR7344

DF70002
09.9467.10
FCR215A
93087000

APPLICATION PAR VEHICULES APPLICATION BY VEHICLES



MAN (TRUCKS) ..I..

TGS (18.320FAC;18.320FAK;18.320FAK-

L;18.320FALK;18.320FALK-

L;18.320FALS;18.320FAS;18.320FC;18.320FHLC;18.320FHLK;18.320FHLK/M;18.320FHLS;18.320FHLS/M;18.320FK;18.320FK-

L;18.320FLC;18.320FLK;18.320FLK/M;18.320FLLC;18.320FLRC;18.320FLLRS;18.320FLLS;18.320FLLS/N;18.320FLLW;18.320FLLW/N;18.320FLRC;18.320FLRS;18.320FLRS/M;18.320FLS;18.320FLS/M;18.320FLS-

TS;18.350FAC;18.350FAK;18.350FAS;18.360FAC;18.360FAK;18.360FAK-L;18.360FALK;18.360FALK-

L;18.360FALS;18.360FAS;18.360FC;18.360FHLC;18.360FHLK;18.360FHLK/M;18.360FHLS;18.360FHLS/M;18.360FK;18.360FK-

L;18.360FLC;18.360FLK;18.360FLK/M;18.360FLLC;18.360FLRC;18.360FLLRS;18.360FLLS;18.360FLLS/N;18.360FLLW;18.360FLLW/N;18.360FLRC;18.360FLRS;18.360FLRS/M;18.360FLS;18.360FLS/M;18.360FLS-

TS;18.390FAC;18.390FAK;18.390FAS;18.390FHLC;18.400FAC;18.400FAK;18.400FAK-L;18.400FALK;18.400FALK-

L;18.400FALS;18.400FAS;18.400FC;18.400FHLC;18.400FHLK;18.400FHLK/M;18.400FHLS;18.400FHLS/M;18.400FK;18.400FK-

L;18.400FLC;18.400FLK;18.400FLK/M;18.400FLLC;18.400FLRC;18.400FLLRS;18.400FLLS;18.400FLLS/N;18.400FLLW;18.400FLLW/N;18.400FLRC;18.400FLRS;18.400FLRS/M;18.400FLS) (4x2 & 4x4 & 6x2 & 6x2/4 & 6x2/2/4 & 6x4 & 6x6 & 8x2/4 & 8x4 & 8x4/4 & 8x4/6 & 8X6/4 & 8x8) 09.07-

L;18.400FLC;18.400FLK;18.400FLK/M;18.400FLLC;18.400FLRC;18.400FLLRS;18.400FLLS;18.400FLLS/N;18.400FLLW;18.400FLLW/N;18.400FLRC;18.400FLRS;18.400FLRS/M;18.400FLS) (4x2 & 4x4 & 6x2 & 6x2/4 & 6x2/2/4 & 6x4 & 6x6 & 8x2/4 & 8x4 & 8x4/4 & 8x4/6 & 8X6/4 & 8x8) 09.07-

L;18.400FLC;18.400FLK;18.400FLK/M;18.400FLLC;18.400FLRC;18.400FLLRS;18.400FLLS;18.400FLLS/N;18.400FLLW;18.400FLLW/N;18.400FLRC;18.400FLRS;18.400FLRS/M;18.400FLS) (4x2 & 4x4 & 6x2 & 6x2/4 & 6x2/2/4 & 6x4 & 6x6 & 8x2/4 & 8x4 & 8x4/4 & 8x4/6 & 8X6/4 & 8x8) 09.07-

L;18.400FLC;18.400FLK;18.400FLK/M;18.400FLLC;18.400FLRC;18.400FLLRS;18.400FLLS;18.400FLLS/N;18.400FLLW;18.400FLLW/N;18.400FLRC;18.400FLRS;18.400FLRS/M;18.400FLS) (4x2 & 4x4 & 6x2 & 6x2/4 & 6x2/2/4 & 6x4 & 6x6 & 8x2/4 & 8x4 & 8x4/4 & 8x4/6 & 8X6/4 & 8x8) 09.07-

L;18.400FLC;18.400FLK;18.400FLK/M;18.400FLLC;18.400FLRC;18.400FLLRS;18.400FLLS;18.400FLLS/N;18.400FLLW;18.400FLLW/N;18.400FLRC;18.400FLRS;18.400FLRS/M;18.400FLS) (4x2 & 4x4 & 6x2 & 6x2/4 & 6x2/2/4 & 6x4 & 6x6 & 8x2/4 & 8x4 & 8x4/4 & 8x4/6 & 8X6/4 & 8x8) 09.07-

L;18.400FLC;18.400FLK;18.400FLK/M;18.400FLLC;18.400FLRC;18.400FLLRS;18.400FLLS;18.400FLLS/N;18.400FLLW;18.400FLLW/N;18.400FLRC;18.400FLRS;18.400FLRS/M;18.400FLS) (4x2 & 4x4 & 6x2 & 6x2/4 & 6x2/2/4 & 6x4 & 6x6 & 8x2/4 & 8x4 & 8x4/4 & 8x4/6 & 8X6/4 & 8x8) 09.07-

KNORR SB-SN7

AXIAL (0°) POTENTIO.
CONTINU VIS

EFR7326

EFR7327

2920200764
2927801

W0400MA
98032000

DF70001

09.9435.10

FCR214A

93087200

22,5"

KNORR SB-SN7

AV/F

AXIAL (8°+)

EFR7336

EFR7337

292530539

2927900604
2927901

WABCO MAXX 22

EFR7004

EFR7005

2927900604
2927901

KNORR SB-SN6

AXIAL (5°+)

POTENTIO. CONTINU
VIS (Essieu
directionnel/ Steering
axle)

EFR6314

EFR6315

2932003
CVP036K

W0400MA
98032000

19,5"

AR/R2

KNORR SB-SN7

AXIAL (0°) POTENTIO.
CONTINU VIS (Essieu
directionnel/ Steering
axle)

EFR7344

EFR7345

2920200764
2927801

W0400MA
98032000

DF70002

09.9467.10

FCR215A

93087000

22,5"

KNORR SB-SN7

AXIAL (0°) POTENTIO.
CONTINU VIS

EFR7302

EFR7303

292530539

2927900604
2927901

KNORR SB-SN7

AXIAL (0°)

AR/R

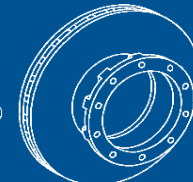
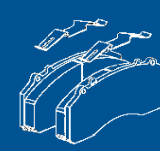
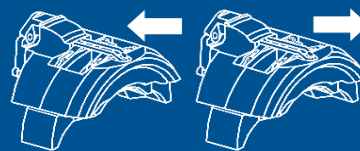
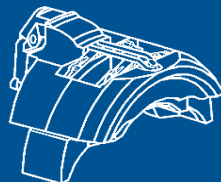
EFR7006

EFR7007

2927900604
2927901

WABCO MAXX 22

APPLICATION PAR VEHICULES APPLICATION BY VEHICLES



MAN (TRUCKS) ..!

TGS (18.400FLS/M;18.400FLS-

TS;18.430FAC;18.430FAK;18.430FAS;18.440FAC;18.440FAK
;18.440FAK-L;18.440FALK;18.440FALK-
L;18.440FALS;18.440FAS;18.440FC;18.440FHLC;18.440FHL
K;18.440FHLK/M;18.440FHLS;18.440FHLS/M;18.440FK;18.4
40FK-

L;18.440FLC;18.440FLK;18.440FLK/M;18.440FLLC;18.440FL
LRC;18.440FLLRS;18.440FLLS;18.440FLLS/N;18.440FLLW;1
8.440FLLW/N;18.440FLRC;18.440FLRS;18.440FLRS/M;18.44

0FLS;18.440FLS/M;18.440FLS-

TS;18.440LLS/N;18.480FAC;18.480FAK;18.480FAK-

L;18.480FALK;18.480FALK-

L;18.480FALS;18.480FAS;18.480FC;18.480FHLC;18.480FHL
K;18.480FHLK/M;18.480FHLS;18.480FK;18.480FK-

L;18.480FLC;18.480FLK;18.480FLK/M;18.480FLLC;18.480FL
LRC;18.480FLLRS;18.480FLLS;18.480FLLS/N;18.480FLLW;1
8.480FLLW/N;18.480FLRC;18.480FLRS;18.480FLRS/M;18.48

0FLS;18.480FLS/M;18.480FLS-

TS;18.540FAC;18.540FAK;18.540FAK-

L;18.540FALK;18.540FALK-

L;18.540FALS;18.540FAS;18.540FC;18.540FHLC;18.540FHL
K;18.540FHLK/M;18.540FHLS;18.540FHLS/M;18.540FK;18.5
40FK-

L;18.540FLC;18.540FLK;18.540FLK/M;18.540FLLC;18.540FL
LRC;18.540FLLRS;18.540FLLS;18.540FLLS/N;18.540FLLW;1
8.540FLLW/N;18.540FLRC;18.540FLRS;18.540FLRS/M;18.54

0FLS;18.540FLS/M;19.350FLRS) (4x2 & 4x4 & 6x2 & 6x2/4
& 6x2/2/4 & 6x4 & 6x6 & 8x2/4 & 8x4 & 8x4/4 & 8x4/6 &

8X6/4 & 8x8) 09.07-

KNORR SB-SN7

AXIAL (0°) POTENTIO.
CONTINU VIS

EFR7326

EFR7327

2920200764

W0400MA

DF70001

2927801

98032000

09.9435.10

292530539

FCR214A

93087200

22,5"

KNORR SB-SN7

AV/F

AXIAL (8°+)

EFR7336

EFR7337

2927900604

2927901

WABCO MAXX 22

EFR7004

EFR7005

KNORR SB-SN6

AXIAL (5°+)

POTENTIO. CONTINU
VIS (Essieu
directionnel/ Steering
axle)

EFR6314

EFR6315

2932003

CVP036K

W0400MA

98032000

19,5"

AR/R2

KNORR SB-SN7

AXIAL (0°) POTENTIO.
CONTINU VIS (Essieu
directionnel/ Steering
axle)

EFR7344

EFR7345

2920200764

2927801

W0400MA

DF70002

292530539

98032000

09.9467.10

22,5"

KNORR SB-SN7

AXIAL (0°) POTENTIO.
CONTINU VIS

EFR7345

EFR7344

FCR215A

93087000

KNORR SB-SN7

AXIAL (0°)

AR/R

EFR7302

EFR7303

2927900604

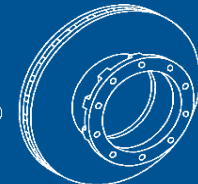
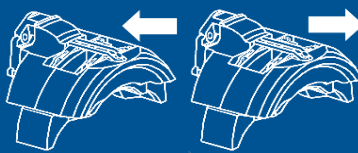
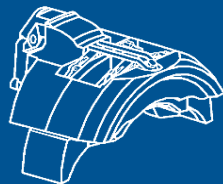
2927901

WABCO MAXX 22

EFR7006

EFR7007

APPLICATION PAR VEHICULES
APPLICATION BY VEHICLES



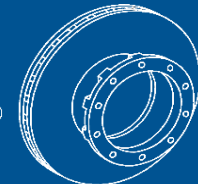
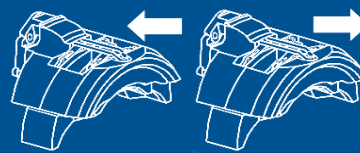
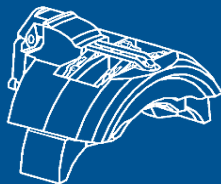
MAN (TRUCKS) ..I..

TGS

(19.350FLS;19.350FRS;19.350FS;19.360FLRS;19.360FLS;19.360FRS;19.360FS;19.390FLRS;19.390FLS;19.390FRS;19.390FS;19.400FLRS/MWW;19.400FLS/MWW;19.400FRS/MWW;19.400FS/MWW;19.430FLRS;19.430FLS;19.430FRS;19.430FS;19.440FLRS-WW;19.440FLS-WW;19.440FRS-WW;19.440FS-WW;19.480FLRS/M-WW;19.480FLS/M-WW;19.480FRS/MWW;19.480FS/M-WW;21.360FLS;21.360FS;21.400FLS;21.400FS;21.440FLS;21.440FS;21.480FLS;21.480FS;24.320FNLLW/N;24.320FPLRS;24.320FPLS;24.360FNLLW/N;24.360FPLRS;24.360FPLS;24.400FNLLW/N;24.400FPLRS;24.400FPLS;24.440FNLLW/N;24.440FPLRS;24.440FPLS;24.480FNLLW/N;24.480FPLRS;24.480FPLS;24.540FPLRS;24.540FPLS;26.320FDAC;26.320FDAK;26.320FDALC;26.320FDALK;26.320FDALS;26.320FDAS;26.320FDLC;26.320FDHK;26.320FDHLC;26.320FDHLC/M;26.320FDHLK;26.320FDHLS;26.320FDHLS/M;26.320FDHS;26.320FDK;26.320FDLC;26.320FDLC/M;26.320FDLK;26.320FDLRC;26.320FDLRC/M;26.320FDLRS;26.320FDLS;26.320FDRC;26.320FDRS;26.320FDS;26.320FDTM;26.320FNHLC;26.320FNHLS;26.320FNLC;26.320FNLLC;26.320FNLLRC;26.320FNLLS;26.320FNLLW;26.320FNLRC;26.320FNLRS;26.320FNLS;26.320FPHLS;26.320FPLRS;26.320FPLS;26.320FVHLC;26.320FVHLS;26.320FVLC;26.320FVLCO;26.320FVL-KO;26.320FVLS;26.350FDLC) (4x2 & 4x4 & 6x2 & 6x2/4 & 6x2/2/4 & 6x4 & 6x6 & 8x2/4 & 8x4 & 8x4/4 & 8x4/6 & 8X6/4 & 8x8) 09.07-

22,5"	KNORR SB-SN7 AXIAL (0°) POTENTIO. CONTINU VIS	AV/F	EFR7326	EFR7327	2920200764 2927801 292530539	W0400MA 98032000	DF70001 09.9435.10 FCR214A 93087200
	KNORR SB-SN7 AXIAL (8°+)		EFR7336	EFR7337			
	WABCO MAXX 22		EFR7004	EFR7005	2927900604 2927901		
19,5"	KNORR SB-SN6 AXIAL (5°+) POTENTIO. CONTINU VIS (Essieu directionnel/ Steering directionnel/ Steering axle)	AR/R2	EFR6314	EFR6315	2932003 CVP036K	W0400MA 98032000	
	KNORR SB-SN7 AXIAL (0°) POTENTIO. CONTINU VIS (Essieu directionnel/ Steering axle)		EFR7344	EFR7345			
22,5"	KNORR SB-SN7 AXIAL (0°) POTENTIO. CONTINU VIS	AR/R	EFR7345	EFR7344	2920200764 2927801 292530539	W0400MA 98032000	DF70002 09.9467.10 FCR215A 93087000
	KNORR SB-SN7 AXIAL (0°)		EFR7302	EFR7303			
	WABCO MAXX 22		EFR7006	EFR7007	2927900604 2927901		

APPLICATION PAR VEHICULES APPLICATION BY VEHICLES



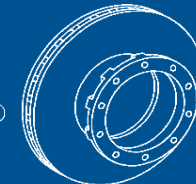
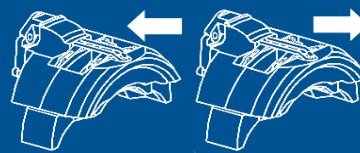
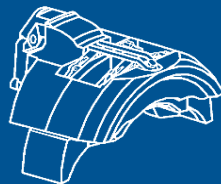
MAN (TRUCKS) ..!..

TGS

(26.350FDLRC;26.350FDLRS;26.350FDLS;26.350FNLC;26.350FNLC;26.350FNLR;26.350FNLS;26.360FDAC;26.360FDALC;26.360FDALK;26.360FDALS;26.360FDAS;26.360FDC;26.360FDHK;26.360FDHLC;26.360FDHLC/M;26.360FDHLK;26.360FDHLS;26.360FDHLS/M;26.360FDHS;26.360FDK;26.360FDLC;26.360FDLK;26.360FDLRC;26.360FDLRS;26.360FDLS;26.360FDRC;26.360FDRC/M;26.360FDRK;26.360FDRS;26.360FDS;26.360FDTM;26.360FNHLC;26.360FNHLS;26.360FNLC;26.360FNLLC;26.360FNLLRC;26.360FNLLS;26.360FNLLW;26.360FNLRC;26.360FNLR;26.360FNLS;26.360FPHLS;26.360FPLRS;26.360FPLS;26.360FVHLC;26.360FVHLS;26.360FVLC;26.360FVLKO;26.360FVLS;26.390FDLC;26.390FDLRC;26.390FDLRS;26.390FDLS;26.390FNLC;26.390FNLR;26.390FNLS;26.400FDAC;26.400FDAK;26.400FDALC;26.400FDALK;26.400FDALS;26.400FDAS;26.400FDC;26.400FDC/M;26.400FDHK;26.400FDHLC;26.400FDHLC/M;26.400FDHLK;26.400FDHLS;26.400FDHLS/M;26.400FDHS;26.400FDK;26.400FDLC;26.400FDLC/M;26.400FDLK;26.400FDLRC;26.400FDLRC/M;26.400FDLRS;26.400FDLS;26.400FDRC;26.400FDRS;26.400FDS;26.400FDTM;26.400FNHLC;26.400FNHLS;26.400FNLC;26.400FNLLC;26.400FNLLRC;26.400FNLLRS;26.400FNLLS;26.400FNLLW;26.400FNLRC;26.400FNLR;26.400FNLS;26.400FPHLS) (4x2 & 4x4 & 6x2 & 6x2/4 & 6x2/2/4 & 6x4 & 6x6 & 8x2/4 & 8x4 & 8x4/4 & 8x4/6 & 8X6/4 & 8x8) 09.07-

22,5"	KNORR SB-SN7 AXIAL (0°) POTENTIO. CONTINU VIS	AV/F	EFR7326	EFR7327	2920200764 2927801 292530539	W0400MA 98032000	DF70001 09.9435.10 FCR214A 93087200
22,5"	KNORR SB-SN7 AXIAL (8°+)	AV/F	EFR7336	EFR7337	2927900604 2927901		
19,5"	WABCO MAXX 22		EFR7004	EFR7005	2927900604 2927901		
19,5"	KNORR SB-SN6 AXIAL (5°+) POTENTIO. CONTINU VIS (Essieu directionnel/ Steering axle)	AR/R2	EFR6314	EFR6315	2932003 CVP036K	W0400MA 98032000	
22,5"	KNORR SB-SN7 AXIAL (0°) POTENTIO. CONTINU VIS (Essieu directionnel/ Steering axle)	AR/R	EFR7344	EFR7345	2920200764 2927801 292530539	W0400MA 98032000	DF70002 09.9467.10 FCR215A 93087000
22,5"	KNORR SB-SN7 AXIAL (0°) POTENTIO. CONTINU VIS	AR/R	EFR7345	EFR7344	2920200764 2927801 292530539	W0400MA 98032000	DF70002 09.9467.10 FCR215A 93087000
	KNORR SB-SN7 AXIAL (0°)		EFR7302	EFR7303			
	WABCO MAXX 22		EFR7006	EFR7007	2927900604 2927901		

APPLICATION PAR VEHICULES APPLICATION BY VEHICLES



MAN (TRUCKS) ..!..

TGS

(26.400FPLRS;26.400FPLS;26.400FVHLC;26.400FVHLS;26.400FVLC;26.400FVL-

KO;26.400FVLS;26.430FDLC;26.430FDLRC;26.430FDLRS;26.430FDLS;26.430FNLC;26.430FNLRC;26.430FNLRS;26.430FNLS;26.440FDAC;26.440FDAK;26.440FDALC;26.440FDALK;26.440FDALS;26.440FDAS;26.440FDC;26.440FDC/M;26.440FDHK;26.440FDHLC;26.440FDHLC/M;26.440FDHLK;26.440FDHLS;26.440FDHLS/M;26.440FDHS;26.440FDK;26.440FDLC;26.440FDLC/M;26.440FDLK;26.440FDLRC;26.440FDLRS;26.440FDLS;26.440FDRC;26.440FDRS;26.440FDS;26.440FD-TM;26.440FNHLC;26.440FNHLS;26.440FNLC;26.440FNLLC;26.440FNLLRC;26.440FNLLS;26.440FNLLW;26.440FNLRC;26.440FNLRS;26.440FNLS;26.440FPHLS;26.440FPLRS;26.440FPLS;26.440FVHLC;26.440FVHLS;26.440FVLC;26.440FVLC

22,5" KNORR SB-SN7 AXIAL (0°) POTENTIO. CONTINU VIS AV/F

22,5" KNORR SB-SN7 AXIAL (8°+) AV/F

19,5" WABCO MAXX 22

19,5" KNORR SB-SN6 AXIAL (5°+) POTENTIO. CONTINU VIS (Essieu directionnel/ Steering axle) AR/R2

22,5" KNORR SB-SN7 AXIAL (0°) POTENTIO. CONTINU VIS (Essieu directionnel/ Steering axle)

22,5" KNORR SB-SN7 AXIAL (0°) POTENTIO. CONTINU VIS AR/R

22,5" KNORR SB-SN7 AXIAL (0°) POTENTIO. CONTINU VIS AR/R2

WABCO MAXX 22

WABCO MAXX 22

KNORR SB-SN7
AXIAL (0°) POTENTIO.
CONTINU VIS

EFR7326

EFR7327

**2920200764
2927801
292530539**

**W0400MA
98032000**

**DF70001
09.9435.10
FCR214A
93087200**

KNORR SB-SN7
AXIAL (8°+)

EFR7336

EFR7337

**2927900604
2927901**

WABCO MAXX 22

EFR7004

EFR7005

**2927900604
2927901**

KNORR SB-SN6
AXIAL (5°+)

POTENTIO. CONTINU
VIS (Essieu
directionnel/ Steering
axle)

EFR6314

EFR6315

**2932003
CVP036K**

**W0400MA
98032000**

KNORR SB-SN7
AXIAL (0°) POTENTIO.
CONTINU VIS (Essieu
directionnel/ Steering
axle)

EFR7344

EFR7345

**2920200764
2927801
292530539**

**W0400MA
98032000**

**DF70002
09.9467.10
FCR215A
93087000**

KNORR SB-SN7
AXIAL (0°) POTENTIO.
CONTINU VIS

EFR7345

EFR7344

KNORR SB-SN7
AXIAL (0°)

EFR7302

EFR7303

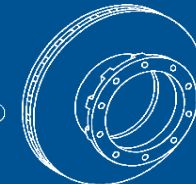
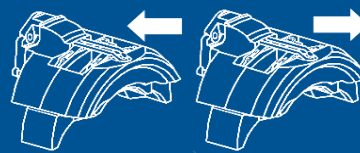
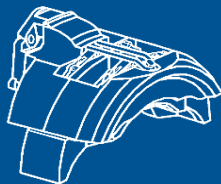
**2927900604
2927901**

WABCO MAXX 22

EFR7006

EFR7007

APPLICATION PAR VEHICULES APPLICATION BY VEHICLES



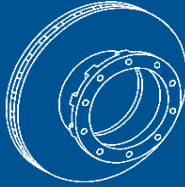
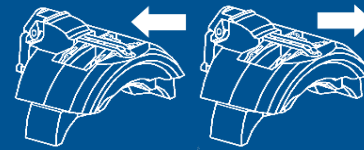
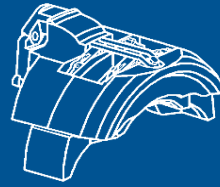
MAN (TRUCKS) ..!..

TGS (26.480FVLC;26.480FVLKO;26.480FVL-

KO;26.480FVLS;26.540FDAC;26.540FDAK;26.540FDALC;26.540FDALK;26.540FDALS;26.540FDAS;26.540FDC;26.540FDC/M;26.540FDHLC;26.540FDHLC/M;26.540FDHLK;26.540FDHLS;26.540FDK;26.540FDLC;26.540FDLC/M;26.540FDLK;26.540FDLRC;26.540FDLRS;26.540FDLS;26.540FDRS;26.540FDS;26.540FNHLC;26.540FNHLS;26.540FNLC;26.540FNLLC;26.540FNLLRC;26.540FNLLS;26.540FNLLW;26.540FNLRC;26.540FNLRS;26.540FNLS;26.540FPHLS;26.540FPLRS;26.540FPLS;26.540FVHLC;26.540FVHLS;26.540FVLC;26.540FVLCO;26.540FVLKO;26.540FVL-
KO;26.540FVLS;28.320FANLC;28.320FANLK;28.320FNHLC;28.320FNLC;28.320FNLS;28.350FNLC;28.350FNLLC;28.350FNLRC;28.350FNLRS;28.350FNLS;28.360FANLC;28.360FANLK;28.360FNHLC;28.360FNLC;28.360FNLRC;28.360FNLRS;28.360FNLS;28.390FNLC;28.390FNLRC;28.390FNLRS;28.390FNLS;28.400FANLC;28.400FANLK;28.400FBLRS;28.400FNHLC;28.400FNLC;28.400FNLRC;28.400FNLS;28.430FNLC;28.430FNLRC;28.430FNLRS;28.430FNLS;28.440FANLC;28.440FANLK;28.440FNHLC;28.440FNLC;28.440FNLRC;28.440FNLRS;28.440FNLS;28.480FANLC;28.480FANLK;28.480FNHLC;28.480FNLC;28.480FNLRC;28.480FNLRS;28.480FNLS;28.540FANLC;28.540FANLK;28.540FNHLC;28.540FNLC;28.540FNLS;32.320FFDRC;32.320FFD-TM;32.350FFDRC) (4x2 & 4x4 & 6x2 & 6x2/4 & 6x2/2/4 & 6x4 & 6x6 & 8x2/4 & 8x4 & 8x4/4 & 8x4/6 & 8X6/4 & 8x8) 09.07-

22,5"	KNORR SB-SN7 AXIAL (0°) POTENTIO. CONTINU VIS	AV/F	EFR7326	EFR7327	2920200764 2927801 292530539	W0400MA 98032000	DF70001 09.9435.10 FCR214A 93087200
	KNORR SB-SN7 AXIAL (8°+)		EFR7336	EFR7337			
	WABCO MAXX 22		EFR7004	EFR7005	2927900604 2927901		
19,5"	KNORR SB-SN6 AXIAL (5°+) POTENTIO. CONTINU VIS (Essieu directionnel/ Steering axle)	AR/R2	EFR6314	EFR6315	2932003 CVP036K	W0400MA 98032000	
	KNORR SB-SN7 AXIAL (0°) POTENTIO. CONTINU VIS (Essieu directionnel/ Steering axle)		EFR7344	EFR7345			
22,5"	KNORR SB-SN7 AXIAL (0°) POTENTIO. CONTINU VIS	AR/R	EFR7345	EFR7344	2920200764 2927801 292530539	W0400MA 98032000	DF70002 09.9467.10 FCR215A 93087000
	KNORR SB-SN7 AXIAL (0°)		EFR7302	EFR7303			
	WABCO MAXX 22		EFR7006	EFR7007	2927900604 2927901		

APPLICATION PAR VEHICULES APPLICATION BY VEHICLES



MAN (TRUCKS) ..!

TGS (32.360FFDRC;32.360FFDR-TM;32.360FFD-

TM;32.390FFDRC;32.400FFDRC;32.400FFDR-

TM;32.400FFD-TM;32.440FFDRC;32.440FFDR-

TM;32.440FFD-TM;32.480FFDRC;32.480FFD-

TM;33.320FDAC;33.320FDAK;33.320FDALC;33.320FDALK;3

3.320FDALS;33.320FDAS;33.320FDC;33.320FDK;33.320FDL

C;33.320FDLK;33.320FDLRC;33.320FDLS;33.320FDRC;33.3

20FDS;33.350FDAC;33.350FDAK;33.350FDALK;33.350FDAL

S;33.350FDARC;33.350FDAS;33.350FDC;33.350FDC-

TM;33.350FDK;33.350FDLC;33.350FDLS;33.350FDR;33.350

FDRK;33.350FDR;33.350FDRK;33.350FDRS;33.350FDS;33.360FDAC;33.36

0FDAK;33.360FDALC;33.360FDALK;33.360FDALS;33.360FD

ARC;33.360FDARK;33.360FDARS;33.360FDAS;33.360FDC;3

3.360FDC-

TM;33.360FDHK;33.360FDHS;33.360FDK;33.360FDLC;33.36

0FDLK;33.360FDLRC;33.360FDLS;33.360FDR;33.360FDRK;

33.360FDR;33.360FDRK;33.360FDRS;33.360FDS;33.390FDAC;33.39

0FDAK;33.390FDALC;33.390FDARC;33.390FDARK;33.390F

DARS;33.390FDAS;33.390FDC;33.390FDC-

TM;33.390FDK;33.390FDLS;33.390FDR;33.390FDRK;33.390

FDR;33.390FDR;33.390FDRK;33.390FDRS;33.390FDS;33.400FDAC;33.40

0FDAK;33.400FDALC;33.400FDALK;33.400FDALS;33.400FD

ARC;33.400FDARK;33.400FDARS;33.400FDAS;33.400FDC;3

3.400FDC-TM;33.400FDHK;33.400FDHS;33.400FDK) (4x2 &

4x4 & 6x2 & 6x2/4 & 6x2/2/4 & 6x4 & 6x6 & 8x2/4 & 8x4

& 8x4/4 & 8x4/6 & 8x6/4 & 8x8) 09.07-

KNORR SB-SN7
AXIAL (0°) POTENTIO.
CONTINU VIS

EFR7326

EFR7327

2920200764

W0400MA

DF70001

2927801

98032000

09.9435.10

292530539

FCR214A

93087200

22,5"

KNORR SB-SN7

AV/F

EFR7336

EFR7337

AXIAL (8°+)

WABCO MAXX 22

EFR7004

EFR7005

2927900604

2927901

KNORR SB-SN6

AXIAL (5°+)

POTENTIO. CONTINU

VIS (Essieu

directionnel/ Steering

axle)

AR/R2

EFR6314

EFR6315

2932003

CVP036K

W0400MA

98032000

19,5"

KNORR SB-SN7

AXIAL (0°) POTENTIO.

CONTINU VIS (Essieu

directionnel/ Steering

axle)

EFR7344

EFR7345

KNORR SB-SN7

AXIAL (0°) POTENTIO.

CONTINU VIS

EFR7345

EFR7344

2920200764

2927801

292530539

W0400MA

98032000

DF70002

09.9467.10

FCR215A

93087000

22,5"

KNORR SB-SN7

AXIAL (0°)

AR/R

EFR7302

EFR7303

WABCO MAXX 22

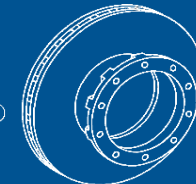
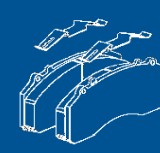
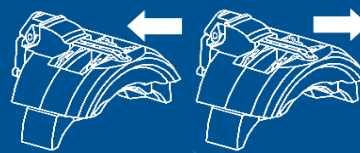
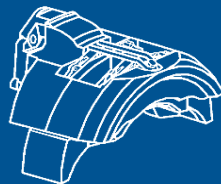
EFR7006

EFR7007

2927900604

2927901

APPLICATION PAR VEHICULES APPLICATION BY VEHICLES



MAN (TRUCKS) ..!

TGS

(33.400FDLC;33.400FDLK;33.400FDLRC;33.400FDLS;33.400FDR;33.400FDRC;33.400FDRC-

TM;33.400FDRK;33.400FDRS;33.400FDS;33.430FDAC;33.430FDAK;33.430FDARC;33.430FDARK;33.430FDARS;33.430FDAS;33.430FDC;33.430FDC-

TM;33.430FDK;33.430FDLC;33.430FDLS;33.430FDR;33.430FDRC;33.430FDRC-

TM;33.430FDRK;33.430FDRS;33.430FDS;33.440FDAC;33.440FDAK;33.440FDALC;33.440FDALK;33.440FDALS;33.440FDARC;33.440FDARK;33.440FDARS;33.440FDAS;33.440FDC;33.440FDC-

TM;33.440FDHK;33.440FDHS;33.440FDK;33.440FDLC;33.440FDLK;33.440FDLRC;33.440FDLS;33.440FDLS/M;33.440FDR;33.440FDRC;33.440FDRC-

TM;33.440FDRK;33.440FDRS;33.440FDS;33.480FDAC;33.480FDAK;33.480FDALC;33.480FDALK;33.480FDALS;33.480FDARC;33.480FDARK;33.480FDARS;33.480FDAS;33.480FDC;33.480FDC/M;33.480FDC-

TM;33.480FDHK;33.480FDHS;33.480FDK;33.480FDLC;33.480FDLK;33.480FDLRC;33.480FDLS;33.480FDLS/M;33.480FDR;33.480FDRC;33.480FDRC-

TM;33.480FDRS;33.480FDS;33.540FDAC;33.540FDAK;33.540FDALC;33.540FDALK;33.540FDALS;33.540FDAS;33.540FDAC;33.540FDK;33.540FDLC;33.540FDLC/M;33.540FDLK;33.540FDLRC;33.540FDLS;33.540FDLS/M;33.540FDRC;33.540FDRS;35.320FDNLC;35.320FFDAK;35.320FFDC;35.320FFDHLK)

(4x2 & 4x4 & 6x2 & 6x2/4 & 6x2/2/4 & 6x4 & 6x6 & 8x2/4 & 8x4 & 8x4/4 & 8x4/6 & 8X6/4 & 8x8) 09.07-

KNORR SB-SN7
AXIAL (0°) POTENTIO.
CONTINU VIS

EFR7326

EFR7327

**2920200764
2927801
292530539**

**W0400MA
98032000**

**DF70001
09.9435.10
FCR214A
93087200**

22,5"

KNORR SB-SN7
AXIAL (8°+)

AV/F

EFR7336

EFR7337

**2920200764
2927801
292530539**

**W0400MA
98032000**

**DF70001
09.9435.10
FCR214A
93087200**

WABCO MAXX 22

EFR7004

EFR7005

**2927900604
2927901**

19,5"

KNORR SB-SN6
AXIAL (5°+)
POTENTIO. CONTINU
VIS (Essieu
directionnel/ Steering
axle)

AR/R2

EFR6314

EFR6315

**2932003
CVP036K**

**W0400MA
98032000**

KNORR SB-SN7
AXIAL (0°) POTENTIO.
CONTINU VIS (Essieu
directionnel/ Steering
axle)

AR/R2

EFR7344

EFR7345

**2920200764
2927801
292530539**

**W0400MA
98032000**

**DF70002
09.9467.10
FCR215A
93087000**

22,5"

KNORR SB-SN7
AXIAL (0°) POTENTIO.
CONTINU VIS

EFR7345

EFR7344

**2920200764
2927801
292530539**

**W0400MA
98032000**

**DF70002
09.9467.10
FCR215A
93087000**

KNORR SB-SN7
AXIAL (0°)

AR/R

EFR7302

EFR7303

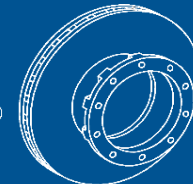
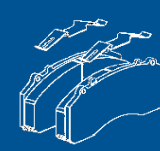
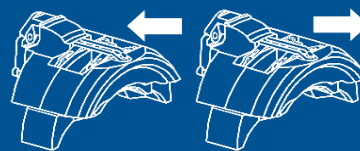
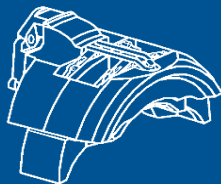
**2927900604
2927901**

WABCO MAXX 22

EFR7006

EFR7007

APPLICATION PAR VEHICULES APPLICATION BY VEHICLES



MAN (TRUCKS) ..!..

TGS

(35.320FFDK;35.320FFDLC;35.320FFDLK;35.320FFDRK;35.320FFD-

TM;35.320FFNHLC;35.320FFNLC;35.350FDAC;35.350FDAR C;35.360FDNLC;35.360FFDAK;35.360FFDC;35.360FFDHLK; 35.360FFDK;35.360FFDLC;35.360FFDLK;35.360FFDRK;35.360FFD-

TM;35.360FFNHLC;35.360FFNLC;35.390FFDAK;35.400FDNL C;35.400FFDAK;35.400FFDC;35.400FFDHLK;35.400FFDK;35.400FFDLC;35.400FFDLK;35.400FFDRK;35.400FFD-

TM;35.400FFNHLC;35.400FFNLC;35.430FFDAK;35.440FDNL C;35.440FFDAK;35.440FFDC;35.440FFDHLK;35.440FFDK;35.440FFDLC;35.440FFDLK;35.440FFDRK;35.440FFD-

TM;35.440FFNHLC;35.440FFNLC;35.480FDNLC;35.480FFD AK;35.480FFDC;35.480FFDHLK;35.480FFDK;35.480FFDLC; 35.480FFDLK;35.480FFDRK;35.480FFD-

TM;35.480FFNHLC;35.480FFNLC;35.540FDNLC;35.540FFD AK;35.540FFDC;35.540FFDHLK;35.540FFDK;35.540FFDLC; 35.540FFDLK;35.540FFDRK;35.540FFD-

TM;35.540FFNHLC;35.540FFNLC;37.320FFDC;37.320FFDK; 37.320FFD-TM;37.360FFDC;37.360FFDK;37.360FFD-

TM;37.400FFDC;37.400FFDK;37.400FFD-

TM;37.440FFDC;37.440FFDK;37.440FFD-

TM;37.480FFDC;37.480FFDK;37.480FFD-

TM;37.540FFDC;37.540FFDK;37.540FFD-

TM;40.360FDAK;40.360FDARK;40.360FDARS;40.360FDAS;40.360FDK;40.360FDRK;40.360FDRS;40.360FDS;40.390FDA K;40.390FDARK;40.390FDARS;40.390FDAS;40.390FDK;40.390FDRK) (4x2 & 4x4 & 6x2 & 6x2/4 & 6x2/2/4 & 6x4 & 6x6 & 8x2/4 & 8x4 & 8x4/4 & 8x4/6 & 8X6/4 & 8x8)

09.07-

KNORR SB-SN7
AXIAL (0°) POTENTIO.
CONTINU VIS

EFR7326

EFR7327

**2920200764
2927801
292530539**

**W0400MA
98032000**

**DF70001
09.9435.10
FCR214A
93087200**

22,5"

KNORR SB-SN7
AXIAL (8°+)

AV/F

EFR7336

EFR7337

**2927900604
2927901**

WABCO MAXX 22

EFR7004

EFR7005

19,5"

KNORR SB-SN6
AXIAL (5°+)
POTENTIO. CONTINU
VIS (Essieu
directionnel/ Steering
axle)

AR/R2

EFR6314

EFR6315

**2932003
CVP036K**

**W0400MA
98032000**

KNORR SB-SN7
AXIAL (0°) POTENTIO.
CONTINU VIS (Essieu
directionnel/ Steering
axle)

EFR7344

EFR7345

22,5"

KNORR SB-SN7
AXIAL (0°) POTENTIO.
CONTINU VIS

EFR7345

EFR7344

**2920200764
2927801
292530539**

**W0400MA
98032000**

**DF70002
09.9467.10
FCR215A
93087000**

KNORR SB-SN7
AXIAL (0°)

AR/R
AR/R2

EFR7302

EFR7303

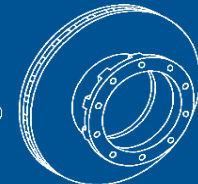
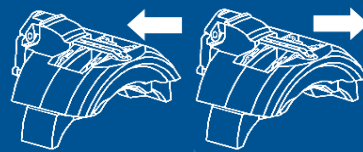
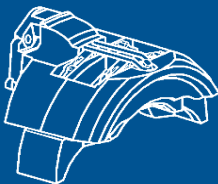
**2927900604
2927901**

WABCO MAXX 22

EFR7006

EFR7007

**APPLICATION PAR VEHICULES
APPLICATION BY VEHICLES**



MAN (TRUCKS) ..!..

TGS (40.390FDRS;40.390FDS;40.400FDAK-WW;40.400FDARKWW;40.400FDARSWW;40.400FDAS-WW;40.400FDK;40.400FDRK;40.400FDRS;40.400FDS;40.430FDAK;40.430FDARK;40.430FDARS;40.430FDAS;40.430FDK;40.430FDRK;40.430FDRS;40.430FDS;40.440FDAK-WW;40.440FDARKWW;40.440FDARSWW;40.440FDAS-WW;40.440FDK;40.440FDRK;40.440FDRS;40.440FDS;40.480FDAK;40.480FDARK;40.480FDARS;40.480FDAS;40.480FDK;40.480FDRK;40.480FDRS;40.480FDS;41.320FFDAK;41.320FFDK;41.320FFDC-TM;41.350FFDK;41.350FFDC-TM;41.350FFDK;41.350FFDRC;41.350FFDRC-TM;41.350FFDRK;41.360FFD;41.360FFDAK;41.360FFDC;41.360FFDC-TM;41.360FFDK;41.360FFDRC;41.360FFDRC-TM;41.360FFDRK;41.360FFD-TM;41.390FFDAK;41.390FFDC;41.390FFDC-TM;41.390FFDK;41.390FFDRC;41.390FFDRC-TM;41.390FFDRK;41.400FFD;41.400FFDAK;41.400FFDC;41.400FFDC-TM;41.400FFDK;41.400FFDRC;41.400FFDRCTM;41.400FFDRK;41.400FFD-TM;41.430FFDAK;41.430FFDC;41.430FFDC-TM;41.430FFDK;41.430FFDRC;41.430FFDRC-TM;41.430FFDRK;41.440FFD;41.440FFDAK;41.440FFDARC;41.440FFDC;41.440FFDC-TM;41.440FFDK;41.440FFDRC;41.440FFDRCTM;41.440FFDRK;41.440FFD-TM;41.480FDRK;41.480FFD;41.480FFDAK;41.480FFDARC;41.480FFDC;41.480FFDC-TM;41.480FFDK;41.480FFDRC;41.480FFDRCTM;41.480FFD-TM;41.540FFDAK;41.540FFDC;41.540FFDK;41.540FFD-TM) (4x2 & 4x4 & 6x2 & 6x2/4 & 6x2/2/4 & 6x4 & 6x6 & 8x2/4 & 8x4 & 8x4/4 & 8x4/6 & 8X6/4 & 8x8) 09.07-

KNORR SB-SN7
22,5" AXIAL (0°) POTENTIO. CONTINU VIS

KNORR SB-SN7
22,5" AXIAL (8°+)

WABCO MAXX 22

KNORR SB-SN6
19,5" AXIAL (5°+)
POTENTIO. CONTINU VIS (Essieu directionnel/ Steering axle)

KNORR SB-SN7
AXIAL (0°) POTENTIO. CONTINU VIS (Essieu directionnel/ Steering axle)

KNORR SB-SN7
AXIAL (0°) POTENTIO. CONTINU VIS

KNORR SB-SN7
AXIAL (0°)

WABCO MAXX 22

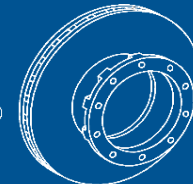
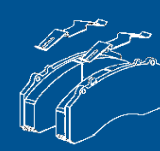
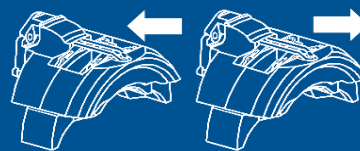
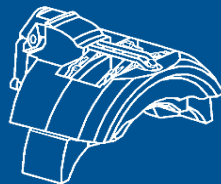
AV/F

AR/R2

AR/R

EFR7326 **EFR7327** **2920200764** **W0400MA** **DF70001**
2927801 **292530539** **98032000** **09.9435.10**
EFR7336 **EFR7337** **EFR7004** **EFR7005** **2927900604** **FCR214A**
2927901 **2932003** **2927901** **W0400MA** **93087200**
CVP036K **98032000**
EFR6314 **EFR6315** **EFR7344** **EFR7345** **2920200764** **DF70002**
2927801 **292530539** **W0400MA** **98032000** **09.9467.10**
EFR7345 **EFR7344** **FCR215A**
93087000
EFR7302 **EFR7303**
EFR7006 **EFR7007** **2927900604** **2927901**

APPLICATION PAR VEHICULES APPLICATION BY VEHICLES



MAN (TRUCKS) ..!..

TGX

(18.360FHLC;18.360FHLS;18.360FHLS/M;18.360FLC;18.360FLLC;18.360FLLRC;18.360FLLRS;18.360FLLRS/N;18.360FLS;18.360FLS/N;18.360FLLW;18.360FLLW/N;18.360FLRC;18.360FLRS;18.360FLRS/N;18.360FLS;18.360FLS/M;18.400FHLC;18.400FHLS;18.400FHLS/M;18.400FLC;18.400FLLC;18.400FLLRC;18.400FLLRS;18.400FLLRS/N;18.400FLLS;18.400FLLS/N;18.400FLLW;18.400FLLW/N;18.400FLRC;18.400FLRS;18.400FLRS/N;18.400FLS;18.400FLS/M;18.440FHLC;18.440FHLS;18.440FHLS/M;18.440FLC;18.440FLLC;18.440FLLRC;18.440FLLRS;18.440FLLRS/M;18.440FLLS;18.440FLLS/N;18.440FLLW;18.440FLLW/N;18.440FLRC;18.440FLRS;18.440FLRS/M;18.440FLRS/N;18.440FLS;18.440FLS/M;18.440FLSS;18.440FLSS/N;18.480FHLC;18.480FHLS;18.480FHLS/M;18.480FLC;18.480FLLC;18.480FLLRC;18.480FLLRS;18.480FLLRS/N;18.480FLLS;18.480FLLS/N;18.480FLLW;18.480FLLW/N;18.480FLRC;18.480FLRS;18.480FLRS/N;18.480FLS;18.480FLS/M;18.540FHLC;18.540FHLS;18.540FHLS/M;18.540FLC;18.540FLLC;18.540FLLRC;18.540FLLRS;18.540FLLRS/N;18.540FLLS;18.540FLLS/N;18.540FLLW;18.540FLLW/N;18.540FLRC;18.540FLRS;18.540FLRS/N;18.540FLS;18.540FLS/M;18.680FLS;24.360FNLLW/N;24.360FPLRS;24.360FPLS;24.400FNLLW/N;24.400FPLRS;24.400FPLS;24.440FNLLW/N;24.440FPLRS;24.440FPLS;24.480FNLLW/N;24.480FPLRS;24.480FPLS;24.540FNLLW/N;24.540FPLRS;24.540FPLS;26.320FNLLS;26.320FNLRS) (4x2 & 4x4 & 6x2 & 6x2/2/4 & 6x4 & 6x6 & 8x4/4) 09.07-

KNORR SB-SN7
AXIAL (0°) POTENTIO.
CONTINU VIS

EFR7326

EFR7327

2920200764
2927801
292530539

W0400MA
98032000

DF70001
09.9435.10
FCR214A
93087200

AV/F

KNORR SB-SN7
AXIAL (8°+)

EFR7336

EFR7337

WABCO MAXX 22

EFR7004

EFR7005

2927900604
2927901

22,5"

KNORR SB-SN7
AXIAL (0°) POTENTIO.
CONTINU VIS (Essieu
directionnel/ Steering
axle)

AR/R2

EFR7344

EFR7345

2920200764
2927801
292530539

W0400MA
98032000

DF70002
09.9467.10
FCR215A
93087000

KNORR SB-SN7
AXIAL (0°) POTENTIO.
CONTINU VIS

AR/R

EFR7345

EFR7344

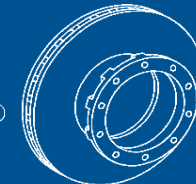
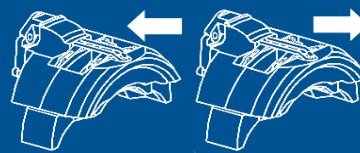
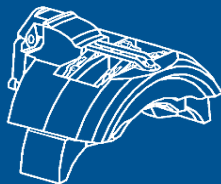
WABCO MAXX 22

EFR7006

EFR7007

2927900604
2927901

APPLICATION PAR VEHICULES APPLICATION BY VEHICLES



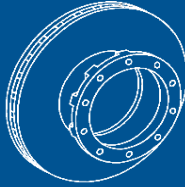
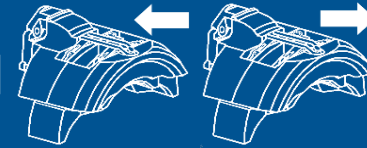
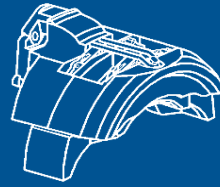
MAN (TRUCKS) ..!..

TGX

(26.480FNLLRS;26.480FNLLS;26.480FNLLW;26.480FNLRC;
26.480FNLRS;26.480FNLS;26.480FPHLS;26.480FPLRS;26.4
80FPLS;26.480FVHLS;26.480FVLS;26.540FDC;26.540FDC/M
;26.540FDLC;26.540FDLRC;26.540FDLRS;26.540FDLS;26.5
40FDRC;26.540FDRC/M;26.540FDRS;26.540FDS;26.540FNL
C;26.540FNLLC;26.540FNLLRC;26.540FNLLS;26.540FNLLW
;26.540FNLRC;26.540FNLRS;26.540FNLS;26.540FPLRS;26.
540FPLS;26.540FVHLS;26.540FVLS;27.440FNS;28.360FNLC
;28.360FNLS;28.400FNLC;28.400FNLS;28.440FDS;28.440FN
LC;28.440FNLS;28.480FNLC;28.480FNLS;28.540FNLC;28.54
0FNLS;29.440FDRC;32.440FDC;32.440FDLC;32.440FDLRC;
33.360FDC;33.360FDC/M;33.360FDLC;33.360FDLRC;33.360
FDLS;33.360FDLS/M;33.360FDS;33.360FDS/M;33.400FDC;3
3.400FDC/M;33.400FDLC;33.400FDLRC;33.400FDLS;33.400
FDLS/M;33.400FDRC;33.400FDS;33.400FDS/M;33.440FDC;3
3.440FDC/M;33.440FDK;33.440FDLC;33.440FDLK;33.440FD
LRC;33.440FDLS;33.440FDLS/M;33.440FDRC;33.440FDS;33
.440FDS/M;33.480FDC;33.480FDC/M;33.480FDK;33.480FDL
C;33.480FDLK;33.480FDLRC;33.480FDLS;33.480FDLS/M;33.
480FDRC;33.480FDS;33.480FDS/M;33.540FDC;33.540FDC/
M;33.540FDLC;33.540FDLRC;33.540FDLS;33.540FDLS/M;33
.540FDRC;33.540FDS;33.540FDS/M;33.680FDLC;33.680FDL
S;35.360FDNLC;35.400FDNLC;35.440FDNLC;35.480FDNLC;
35.540FDNLC;41.540FVDLS;41.540FVDS;41.680FVDLS;41.6
80FVDSS) (4x2 & 4x4 & 6x2 & 6x2/2/4 & 6x4 & 6x6 &
8x4/4) 09.07-

22,5"	KNORR SB-SN7 AXIAL (0°) POTENTIO. CONTINU VIS		EFR7326	EFR7327				
						2920200764 2927801 292530539	W0400MA 98032000	DF70001 09.9435.10 FCR214A 93087200
	AV/F							
	KNORR SB-SN7 AXIAL (8°+)		EFR7336	EFR7337				
	WABCO MAXX 22		EFR7004	EFR7005		2927900604 2927901		
	KNORR SB-SN7 AXIAL (0°) POTENTIO. CONTINU VIS (Essieu directionnel/ Steering axle)	AR/R2	EFR7344	EFR7345		2920200764 2927801 292530539	W0400MA 98032000	DF70002 09.9467.10 FCR215A 93087000
	KNORR SB-SN7 AXIAL (0°) POTENTIO. CONTINU VIS	AR/R	EFR7345	EFR7344				
						2927900604 2927901		
	WABCO MAXX 22		EFR7006	EFR7007				

APPLICATION PAR VEHICULES
APPLICATION BY VEHICLES



MERCEDES (AXLE)>JOST

DISCOS/POWERSYSTEMS (DCA-DLS;
TDB0637/0874) 01.97-

19,5" KNORR SB-SN6
AXIAL (5°+)

EFR6300

EFR6301

2932004
CVP036K

09.8925.10
FCR190A
93101500

DISCOS/POWERSYSTEMS (DCA-DLS;
TDB0571/0876) 01.97-

22,5" KNORR SB-SN7
AXIAL (-12°)

EFR7300

EFR7301

2920200764
2927801
292530539

DF70000
09.B325.30
FCR145A
93087900

DISCOS/POWERSYSTEMS (DCA-DLS;
TDB0815/0875) 01.06-

22,5" KNORR SK7

EFR6308

EFR6309

2926900604
2926901
292570539

DF70000
09.B325.30
FCR145A
93087900

DISCOS/POWERSYSTEMS (DCA 7111 L-7 & T-7;
TDB0877) 01.19-

22,5" HALDEX DBT 22LT

EFR7210

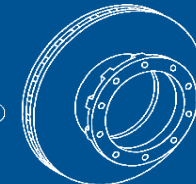
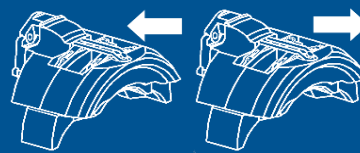
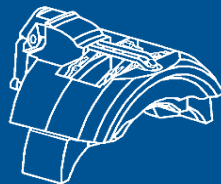
EFR7211

293400956

DF70000
09.B325.30
FCR145A
93087900

Automotive

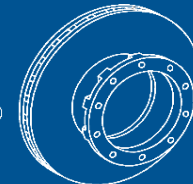
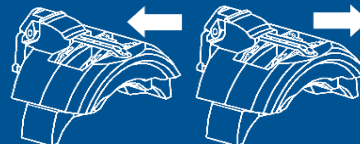
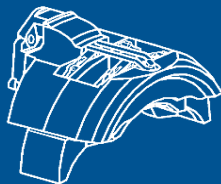
APPLICATION PAR VEHICULES
APPLICATION BY VEHICLES



MERCEDES (CARS ET BUS)

OMNIBUS O340 (4x2) 01.91-08.95	22,5" MERITOR D3	AV/F	EFR7604	EFR7605	2908302	W0280ME3 98017200	09.8129.10
		AR/R	EFR7608	EFR7609			FCR120A 93058200
TOURISMO O350 (15RHD; 15SHD; 16RHD; 16SHD; 17RHD; 17SHD) (4x2 & 6x2) 01.03-	22,5"	KNORR SB-SN7 AXIAL (-12°) POTENTIO. CONTINU	AV/F	EFR7304	EFR7305	2920200764 2927802 292530539	DF70000 09.B325.30 FCR145A 93087900 ou/or DF70008 09.A741.10 FCR323A 93186700
		KNORR SB-SN7 AXIAL (12°+) POTENTIO. CONTINU	AR/R	EFR7312	EFR7313		DF70000 09.B325.30 FCR145A 93087900 DF70000 09.B325.30 FCR145A 93087900 FCR145A 93087900 ou/or DF70008 09.A741.10 FCR323A 93186700
INTURO O403 (E; M; ME) (4x2) 01.03-	22,5"	KNORR SB-SN7 AXIAL (-12°) POTENTIO. CONTINU	AV/F	EFR7304	EFR7305	2920200764 2927802 292530539	DF70000 09.B325.30 FCR145A 93087900 ou/or DF70008 09.A741.10 FCR323A 93186700
		KNORR SB-SN7 AXIAL (12°+) POTENTIO. CONTINU	AR/R	EFR7312	EFR7313		DF70000 09.B325.30 FCR145A 93087900

APPLICATION PAR VEHICULES
APPLICATION BY VEHICLES



MERCEDES (CARS ET BUS)/.

OMNIBUS O404 (4x2 & 6x2) 01.91-10.99

22,5" MERITOR D3

AV/F

EFR7604

EFR7605

2908302

**W0280ME3
98017200**

**09.8129.10
FCR120A
93058200**

AR/R

EFR7608

EFR7609

TOURO O500 (GL; GLE; M; R; RSD; U) (4x2 & 6x2 & 8x2) 01.01-

22,5" KNORR SB-SN7

AV/F

EFR73XX

EFR73XX

**2920200764
2927802
292530539**

**DF70000
09.B325.30
FCR145A
93087900
ou/or
DF70008
09.A741.10
FCR323A
93186700**

AR/R

EFR73XX

EFR73XX

**DF70000
09.B325.30
FCR145A
93087900**

CAPACITY O503GL (CapaCity) (8x2) 04.07-

22,5" KNORR SB-SN7

AV/F

EFR73XX

EFR73XX

**2920200764
2927802
292530539**

**DF70000
09.B325.30
FCR145A
93087900 ou/or
DF70008
09.A741.10
FCR323A
93186700**

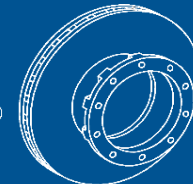
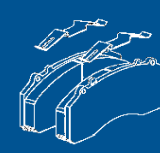
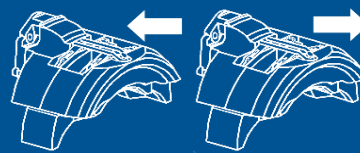
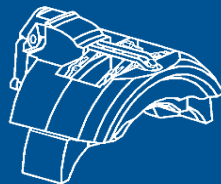
AR/R

EFR73XX

EFR73XX

**DF70000
09.B325.30
FCR145A
93087900**

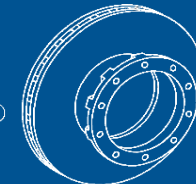
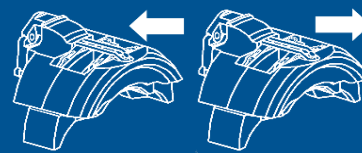
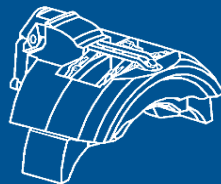
APPLICATION PAR VEHICULES APPLICATION BY VEHICLES



MERCEDES (CARS ET BUS) ../.

TOURINO O510 (4x2) 10.03-	19,5"	KNORR SB-SN6 AXIAL (5°+) POTENTIO. O/F	AV/F	EFR6305	EFR6304	2932002 CVP036K	09.8573.10 FCR189A 93101400
			AR/R				09.8925.10 FCR190A 93101500 DF70000 09.B325.30 FCR145A 93087900 ou/or DF70008
CITO O520 (130 kW) (4x2) 06.99-	22,5"	KNORR SB-SN7 AXIAL (-12°) POTENTIO. CONTINU	AV/F	EFR7304	EFR7305	2920200764 2927802 292530539	09.A741.10 FCR323A 93186700 DF70000
			AR/R	EFR7310	EFR7311		09.B325.30 FCR145A 93087900 DF70000 09.B325.30 FCR145A 93087900 ou/or DF70008
CITARO O530 (BZ; C; G; GN3; GNG; LÜ; MUE; N; NG; Ü) (4x2 & 6x2) 01.98-	22,5"	KNORR SB-SN7 AXIAL (-12°) POTENTIO. CONTINU	AV/F	EFR7304	EFR7305	2920200764 2927802 292530539	09.A741.10 FCR323A 93186700 DF70000
			AR/R	EFR7317	EFR7316		09.B325.30 FCR145A 93087900

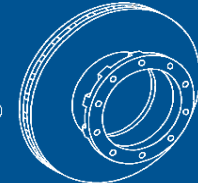
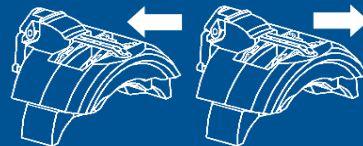
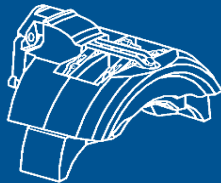
APPLICATION PAR VEHICULES
APPLICATION BY VEHICLES



MERCEDES (CARS ET BUS)/.

INTEGRO O550 (M; L) 10.01-12.05	22,5" MERITOR D3	AV/F	EFR7606	EFR7607	2903009 CVP013K	09.8129.20 FCR114A 93058100
INTEGRO O550 (M; L) 10.01-12.05	KNORR SB-SN7 22,5" AXIAL (12°+) POTENTIO. CONTINU	AV/F	EFR7312	EFR7313	2920200764 2927802 292530539	DF70000 09.B325.30 FCR145A 93087900
INTEGRO O550 (M; L) 01.06-	KNORR SB-SN7 AXIAL (-12°) POTENTIO. CONTINU	AV/F	EFR7304	EFR7305	2920200764 2927802 292530539	DF70000 09.B325.30 FCR145A 93087900 ou/or DF70008 09.A741.10 FCR323A 93186700
	KNORR SB-SN7 AXIAL (12°+) POTENTIO. CONTINU	AR/R	EFR7312	EFR7313		DF70000 09.B325.30 FCR145A 93087900
TRAVEGO O580 (15RH; 15RHD; 15SHD; 16RHD; 17RHD; 17SHD) (4x2 & 6x2) 10.99-	KNORR SB-SN7 AXIAL (-12°) POTENTIO. CONTINU	AV/F	EFR7304	EFR7305	2920200764 2927802 292530539	DF70000 09.B325.30 FCR145A 93087900 ou/or DF70008 09.A741.10 FCR323A 93186700
	KNORR SB-SN7 AXIAL (12°+) POTENTIO. CONTINU	AR/R	EFR7312	EFR7313		DF70000 09.B325.30 FCR145A 93087900

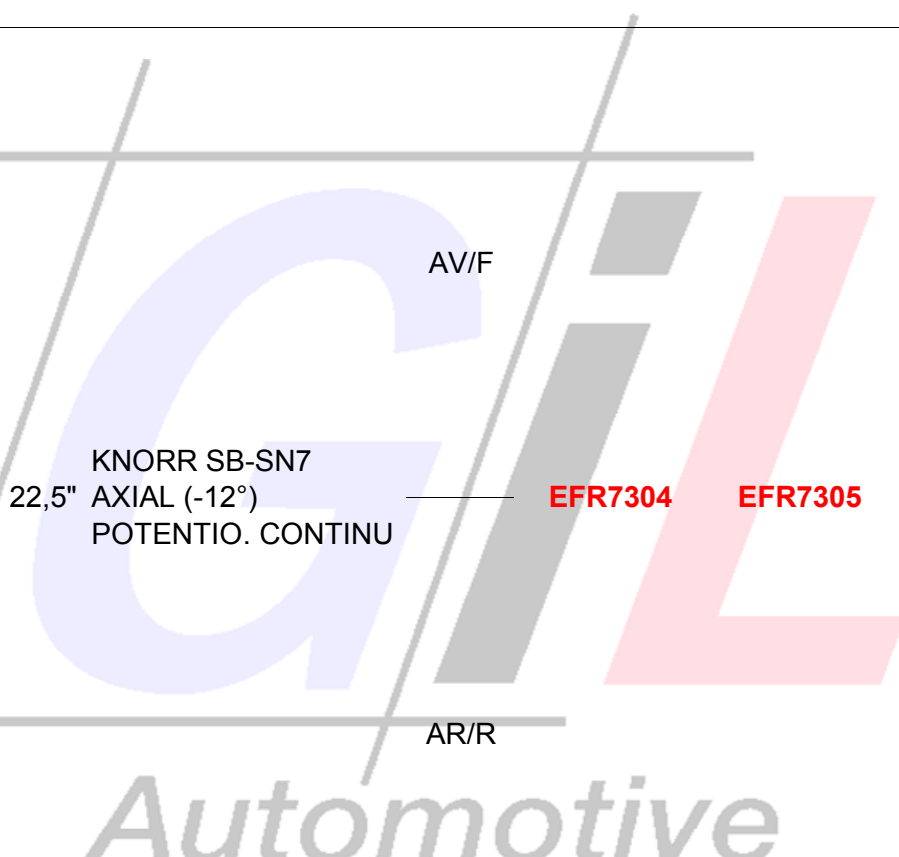
**APPLICATION PAR VEHICULES
APPLICATION BY VEHICLES**



MERCEDES (TRUCKS)

ACTROS & MP2/MP3

(1831;1831K;1831L;1831LS;1831S;1832;1832K;1832L;1832L L;1832LLS;1832LS;1835;1835K;1835L;1835LS;1835S;1836;1836K;1836L;1836LL;1836LLS;1836LS;1840;1840K;1840L;1840LS;1840S;1841;1841K;1841L;1841LL;1841LLS;1841LS;1843;1843K;1843L;1843LS;1843S;1844;1844K;1844L;1844LL;1844LLS;1844LS;1846;1846K;1846L;1846LL;1846LLS;1846LS;1846S;1848;1848K;1848L;1848LL;1848LLS;1848LS;1848S;1850;1850L;1850LL;1850LLS;1850LS;1851;1851K;1851L;1851LL;1851LLS;1851LS;1853;1853L;1853LS;1853S;1854;1854L;1854LS;1855;1855L;1855LL;1855LLS;1855LS;1857L;1857LS;1858;1858L;1858LS;1860L;1860LL;1860LS;1861LS;2031;2031K;2031S;2032;2032K;2032S;2035S;2036;2036K;2036S;2040;2040S;2041;2041K;2041S;2044;2044K;2044S;2046;2046K;2046S;2048;2048K;2048S;2050S;2051S;2053S;2054S;2055S;2432LS;2436LS;2441LS;2444LS;2446LS;2448LS;2451LS;2455LS;2460LS;2531;2531L;2531LS;2532;2532L;2532LL;2532LS;2535L;2535LS;2536;2536L;2536LL;2536LS;2540;2540L;2540LS;2541;2541L;2541LL;2541LS;2543;2543L;2543LS;2544;2544L;2544LL;2544LS;2546;2546L;2546LL;2546LS;2548;2548L;2548LL;2548LS;2550;2550LS;2551;2551L;2551LL;2551LS;2553;2553L;2553LS;2554;2554L;2554LS;2555;2555L;2555LL;2555LS;2557L;2558;2558L;2560;2560L;2560LL;2631;2631B;2631K;2631L;2631K;2631LS;2632;2632B;2632K;2632L;2632LK;2632LL;2632LS;2635;2635B;2635K;2635L;2635LK;2635LS;2636;2636B;2636K;2636L;2636LK;2636LL) (4x2 & 6x2 & 6x2/4 & 6x4 & 8x2/6 & 8x4 & 8x4/4 & 10x4/6) 04.96-06.11



AV/F

KNORR SB-SN7
22,5" AXIAL (-12°)
POTENTIO. CONTINU

AR/R

EFR7304

EFR7305

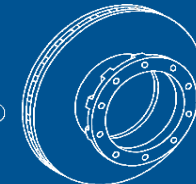
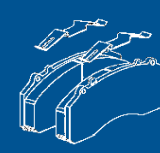
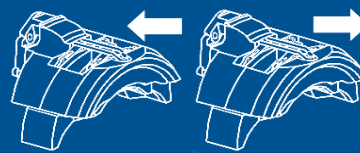
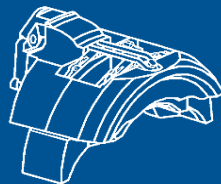
**2920200764
2927801
292530539**

TM

**DF70000
09.B325.30
FCR145A
93087900
ou/or
DF70008
09.A741.10
FCR323A
93186700**

**DF70000
09.B325.30
FCR145A
93087900**

APPLICATION PAR VEHICULES
APPLICATION BY VEHICLES



MERCEDES (TRUCKS) ..!..

ACTROS & MP2/MP3

(2636LS;2640;2640B;2640K;2640L;2640LK;2640LS;2640S;2641;2641B;2641K;2641L;2641LK;2641LL;2641LS;2641S;2643;2643B;2643K;2643L;2643LK;2643LS;2643S;2644;2644B;2644K;2644L;2644LK;2644LL;2644LS;2644S;2646;2646B;2646K;2646L;2646LK;2646LL;2646LS;2646S;2648;2648B;2648K;2648L;2648LK;2648LL;2648LS;2648S;2650;2650K;2650L;2650LK;2650LL;2650LS;2650S;2651K;2651L;2651LK;2651LS;2651S;2653;2653K;2653L;2653LK;2653LS;2653S;2654;2654K;2654L;2654LK;2654LL;2654LS;2654S;2655K;2655L;2655LK;2655LL;2655LS;2655S;2657K;2657L;2657LK;2657LS;2657S;2658K;2658L;2658LK;2658LS;2660L;2660LK;2660LL;2660LS;2660S;2665LS;3231B;3231K;3232B;3232K;3235;3235B;3235K;3236B;3236K;3240;3240B;3240K;3241;3241B;3241K;3241L;3243;3243B;3243K;3244;3244B;3244K;3246;3246B;3246K;3248;3248B;3248K;3248L;3250;3255L;3260L;3331;3331B;3331K;3331S;3332;3332B;3332K;3332S;3335;3335B;3335K;3335S;3336;3336B;3336K;3336S;3339B;3339K;3340;3340B;3340K;3340S;3341;3341B;3341K;3341S;3343;3343B;3343K;3343S;3344;3344B;3344K;3344S;3346;3346B;3346K;3346S;3348;3348B;3348K;3348S;3350;3350K;3350S;3351;3351K;3351S;3353;3353S;3354;3355;3355S;3357;3357S;3358;3360;3550S;4036K;4140B;4140K;4141B;4141K;4143B;4144B;4144K;4146B;4146K;4148B;4148K;4150K;4151K;4154S;4155K;4160K;4160S;4165S;4841K;4844K;5041B;5041K;5044B;5044K;5046B;5046K) (4x2 & 6x2 & 6x2/4 & 6x4 & 8x2/6 & 8x4 & 8x4/4 & 10x4/6) 04.96-06.11

KNORR SB-SN7
22,5" AXIAL (-12°)
POTENTIO. CONTINU

AV/F

AR/R

EFR7304

EFR7305

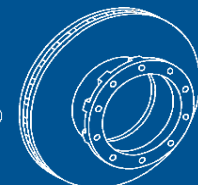
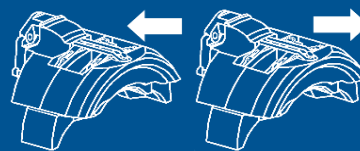
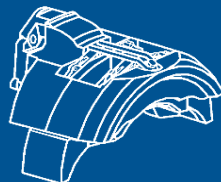
2920200764
2927801
292530539

TM

DF70000
09.B325.30
FCR145A
93087900
ou/or
DF70008
09.A741.10
FCR323A
93186700

DF70000
09.B325.30
FCR145A
93087900

APPLICATION PAR VEHICULES APPLICATION BY VEHICLES



MERCEDES (TRUCKS) ..!..

ACTROS MP4/MP5

(1824L;1824LS;1827L;1827LS;1830L;1830LCNG;1830LS;1832L;1832LS;1833L;1833LS;1835L;1835LS;1836L;1836LS;1840L;1840LS;1842L;1842LS;1843L;1843LS;1845L;1845LS;1846L;1846LS;1848L;1848LS;1851L;1851LS;1852L;1852LS;1853L;1853LS;1858L;1858LS;1863L;1863LS;2024L;2024LS;2027L;2027LS;2030L;2030LS;2032L;2032LS;2033L;2033LS;2035L;2035LS;2036L;2036LS;2040L;2040LS;2042L;2042LS;2043L;2043LS;2045L;2045LS;2046L;2046LS;2048L;2048LS;2051L;2051LS;2052L;2052LS;2053L;2053LS;2058L;2058LS;2063L;2063LS;2424L;2424LS;2427L;2427LS;2430L;2430LS;2432L;2432LS;2433L;2433LS;2435L;2435LS;2436L;2436LS;2440L;2440LS;2442L;2442LS;2443L;2443LS;2445L;2445LS;2446L;2446LS;2448L;2448LS;2451L;2451LS;2452L;2452LS;2453L;2453LS;2458L;2458LS;2463L;2463LS;2524L;2524LS;2527L;2527LS;2530L;2530LCNG;2530LS;2532L;2532LS;2533L;2533LS;2535L;2535LS;2536L;2536LS;2540L;2540LS;2542L;2542LS;2543L;2543LS;2545L;2545LS;2546L;2546LS;2548L;2548LS;2551L;2551LS;2552L;2552LS;2553L;2553LS;2558L;2558LS;2563L;2563LS;2624L;2624LS;2627L;2627LS;2630L;2630LS;2632L;2632LS;2633L;2633LS;2635L;2635LS;2636L;2636LS;2640L;2640LS;2642L;2642LS;2643L;2643LS;2645L;2645LS;2646L;2646LS;2648L;2648LS;2651L;2651LS;2652L;2652LS;2653L;2653LS;2658L;2658LS;2663L;2663LS;3232L;3232LS;3235L;3235LS;3240L;3240LS;3243L;3243LS;3245L;3245LS;3246L;3246LS;3248L;3248LS;3251L;3251LS;3253L;3253LS;3333L;3333LS;3336L;3336LS;3340L;3340LS;3342L;3342LS;3343L;3343LS;3345L;3345LS;3346L;3346LS;3348L;3348LS;3351L;3351LS;3352L;3352LS;3352SLT;3352SLT;3353L;3353LS;3358L;3358LS;3358SLT;3358SLT;3363L;3363LS;3363SLT;3363SLT;4152L;4152LS;4158L;4158LS;4158SLT;4158SLT;eActros300;eActros400) (4x2 & 4x4 & 6x2 & 6x2/4 & 6x4/4 & 6x4 & 6x6 & 8x2/4 & 8x4/4) 07.11-

KNORR SM7 AXIAL
(0°) POTENTIO.
CONTINU VIS

EFR7352

EFR7353

TM

2924601
FCV4417PTS

09.C311.10
FCR372A
93291200

KNORR SM7 AXIAL (-
12°) POTENTIO.
ON/OFF VIS

EFR7348

EFR7349

AV/F

WABCO MAXX 22L

EFR7010

EFR7011

2931501
29315FLE1749

22,5"

KNORR SL7 AXIAL (-
12°) POTENTIO.
CONTINU VIS

EFR7346

EFR7347

2924401
FCV4418PTS

DF70000
09.B325.30
FCR145A
93087900

KNORR SL7 AXIAL (-
12°) POTENTIO.
ON/OFF VIS

EFR7350

EFR7351

AR/R

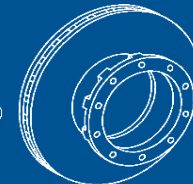
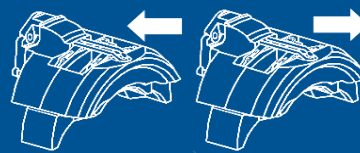
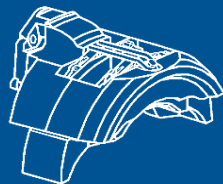
WABCO MAXX 22L

EFR7010

EFR7011

2931501
29315FLE1749

APPLICATION PAR VEHICULES APPLICATION BY VEHICLES



MERCEDES (TRUCKS) ..!..

ANTOS

(1824L;1824LS;1827L;1827LS;1830L;1830LS;1832L;1832LS;1833L;1833LS;1835L;1835LS;1836L;1836LS;1840L;1840LS;1842L;1842LS;1843L;1843LS;1845L;1845LS;1846L;1846LS;1848L;1848LS;1851L;1851LS;1852L;1852LS;1853L;1853LS;1858L;1858LS;1863L;1863LS;2024L;2024LS;2027L;2027LS;2030L;2030LS;2032L;2032LS;2033L;2033LS;2035L;2035LS;2036L;2036LS;2040L;2040LS;2042L;2042LS;2043L;2043LS;2045L;2045LS;2046L;2046LS;2048L;2048LS;2051L;2051LS;2052L;2052LS;2053L;2053LS;2058L;2058LS;2063L;2063LS;2424LS;2427LS;2430LS;2432LS;2433LS;2435LS;2436LS;2440LS;2442LS;2443LS;2445LS;2446LS;2448LS;2451LS;2452LS;2453LS;2458LS;2463LS;2524L;2524LS;2527L;2527LS;2530L;2530LS;2532L;2532LS;2533L;2533LS;2535L;2535LS;2536L;2536LS;2540L;2540LS;2542L;2542LS;2543L;2543LS;2545L;2545LS;2546L;2546LS;2548L;2548LS;2551L;2551LS;2552L;2552LS;2553L;2553LS;2558L;2558LS;2563L;2563LS;2624L;2624LS;2627L;2627LS;2630L;2630LS;2632L;2632LS;2633L;2633LS;2635L;2635LS;2636L;2636LS;2640L;2640LS;2642L;2642LS;2643L;2643LS;2645L;2645LS;2646L;2646LS;2648L;2648LS;2651L;2651LS;2652L;2652LS;2653L;2653LS;2658L;2658LS;2663L;2663LS;3232L;3233L;3235L;3236L;3240L;3242L;3243L;3245L;3246L;3248L;3251L;3253L;3333L;3333LS;3336L;3336LS;3340L;3340LS;3342L;3342LS;3343L;3343LS;3345L;3345LS;3346L;3346LS;3348L;3348LS;3351L;3351LS;3352L;3352LS;3353L;3353LS;3358L;3358LS;3363L;3363LS) (4x2 & 4x4 & 6x2 & 6x2/4 & 6x4 & 6x4/4 & 6x6 & 8x2/4) 07.12-

KNORR SM7 AXIAL
(0°) POTENTIO.
CONTINU VIS

EFR7352

EFR7353

2924601
FCV4417PTS

KNORR SM7 AXIAL (-
12°) POTENTIO.
ON/OFF VIS

AV/F

EFR7348

EFR7349

2924601
FCV4417PTS

WABCO MAXX 22L

22,5"

EFR7010

EFR7011

2931501
29315FLE1749

KNORR SL7 AXIAL (-
12°) POTENTIO.
CONTINU VIS

EFR7346

EFR7347

2924401
FCV4418PTS

KNORR SL7 AXIAL (-
12°) POTENTIO.
ON/OFF VIS

AR/R

EFR7350

EFR7351

2931501
29315FLE1749

WABCO MAXX 22L

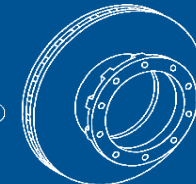
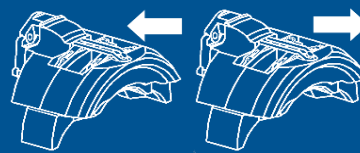
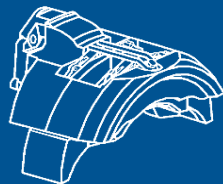
EFR7010

EFR7011

09.C311.10
FCR372A
93291200

DF70000
09.B325.30
FCR145A
93087900

APPLICATION PAR VEHICULES APPLICATION BY VEHICLES



MERCEDES (TRUCKS) ...

AROCS

(1824;1824A;1824AK;1824K;1824L;1824LK;1824LS;1827;1827A;1827AK;1827K;1827L;1827LK;1827LS;1830;1830A;1830AK;1830K;1830L;1830LK;1830LS;1830S;1832;1832A;1832AK;1832K;1832L;1832LK;1832LS;1832S;1833;1833A;1833AK;1833AS;1833K;1833L;1833LK;1833LS;1835;1835A;1835AK;1835K;1835L;1835LK;1835LS;1835S;1836;1836A;1836AK;1836AS;1836K;1836L;1836LK;1836LS;1836S;1840;1840A;1840AK;1840AS;1840K;1840L;1840LK;1840LS;1842;1842A;1842AK;1842AS;1842K;1842L;1842LK;1842LS;1843;1843A;1843AK;1843AS;1843K;1843L;1843LK;1843LS;1845;1845A;1845AK;1845AS;1845K;1845L;1845LK;1845LS;1846;1846A;1846AK;1846AS;1846K;1846L;1846LK;1846LS;1848;1848A;1848AK;1848AS;1848K;1848L;1848LK;1848LS;1851;1851A;1851AK;1851AS;1851K;1851L;1851LK;1851LS;1852;1852L;1852LS;1853;1853A;1853AK;1853AS;1853K;1853L;1853LK;1853LS;1858;1858L;1858LS;1863;1863L;1863LS;2024;2024K;2024L;2024LK;2024LS;2024S;2027;2027K;2027L;2027LK;2027LS;2027S;2030;2030K;2030L;2030LK;2030LS;2030S;2032;2032K;2032L;2032LK;2032LS;2032S;2033;2033A;2033AK;2033AS;2033K;2033L;2033LK;2033LS;2033S;2035;2035K;2035L;2035LK;2035LS;2035S;2036;2036A;2036AK;2036AS;2036K;2036L;2036LK;2036LS;2036S;2040;2040A;2040AK;2040AS;2040K;2040L;2040LK;2040LS;2040S;2042;2042A;2042AK;2042AS;2042K;2042L;2042LK;2042LS;2042S;2043;2043A;2043AK;2043AS;2043K;2043L;2043LK;2043LS;2043S;2045;2045A;2045AK;2045AS;2045K;2045L;2045LK;2045LS;2045S;2046;2046A;2046AK;2046AS;2046K;2046L;2046LK;2046LS;2046S;2048;2048A;2048AK;2048AS;2048K;2048L;2048LK;2048LS;2048S;2051;2051A;2051AK;2051AS;2051K;2051L;2051LK;2051LS;2051S;2052;2052L;2052LS;2052S;2053;2053A;2053AK;2053AS;2053K;2053L) (4x2 & 4x4 & 6x4/4 & 6x4 & 6x2/4 & 6x2 & 6x6 & 8x4/4 & 8x4 & 8x2/4 & 8x8/4 & 8x6/4) 01.13-

KNORR SM7 AXIAL
(0°) POTENTIO.
CONTINU VIS

EFR7352

EFR7353

TM
2924601
FCV4417PTS

KNORR SM7 AXIAL (-12°) POTENTIO.
ON/OFF VIS AV/F

EFR7348

EFR7349

09.C311.10
FCR372A
93291200

WABCO MAXX 22L

EFR7010

EFR7011

2931501
29315FLE1749

22,5"

KNORR SL7 AXIAL (-12°) POTENTIO.
CONTINU VIS

EFR7346

EFR7347

2924401
FCV4418PTS

KNORR SL7 AXIAL (-12°) POTENTIO.
ON/OFF VIS AR/R

EFR7350

EFR7351

DF70000
09.B325.30
FCR145A
93087900

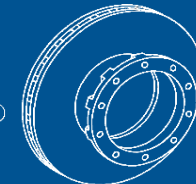
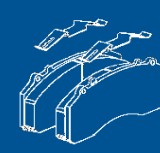
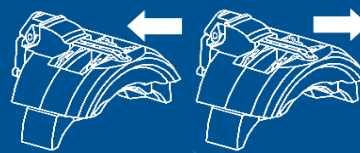
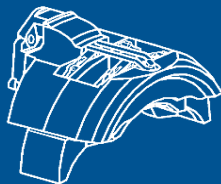
WABCO MAXX 22L

EFR7010

EFR7011

2931501
29315FLE1749

APPLICATION PAR VEHICULES APPLICATION BY VEHICLES



MERCEDES (TRUCKS) ..!..

AROCS

(2053LK;2053LS;2053S;2058;2058L;2058LS;2058S;2063;2063L;2063LS;2063S;2424LS;2524L;2524LS;2527L;2527LS;2530L;2530LS;2532K;2532L;2532LS;2533L;2533LS;2535K;2535L;2535LS;2536L;2536LS;2540L;2540LS;2542L;2542LS;2543L;2543LS;2545L;2545LS;2546L;2546LS;2548L;2548LS;2551L;2551LS;2552L;2552LS;2553L;2553LS;2558L;2558LS;2563L;2563LS;2624;2624B;2624K;2624L;2624LB;2624LK;2624LS;2624S;2627;2627L;2627B;2627K;2627L;2627LB;2627LK;2627LS;2627S;2630;2630B;2630K;2630L;2630LB;2630LK;2630LS;2630S;2632;2632B;2632K;2632L;2632LB;2632LK;2632LS;2632S;2633;2633L;2633B;2633K;2633L;2633LB;2633LK;2633LS;2633S;2635;2635B;2635K;2635L;2635LB;2635LK;2635LS;2635S;2636;2636L;2636B;2636K;2636L;2636LB;2636LK;2636LS;2636S;2640;2640B;2640K;2640L;2640LB;2640LK;2640LS;2640S;2642;2642L;2642B;2642K;2642L;2642LB;2642LK;2642LS;2642S;2643;2643B;2643K;2643L;2643LB;2643LK;2643LS;2643S;2645;2645B;2645K;2645L;2645LB;2645LK;2645LS;2645S;2646;2646B;2646K;2646L;2646LB;2646LK;2646LS;2646S;2648;2648B;2648K;2648L;2648LB;2648LK;2648LS;2648S;2651;2651B;2651K;2651L;2651LB;2651LK;2651LS;2651S;2652;2652K;2652L;2652LK;2652LS;2652S;2653;2653B;2653K;2653L;2653LB;2653LK;2653LS;2653S;2658;2658K;2658L;2658LK;2658LS;2658S;2663;2663K;2663L;2663LK;2663LS;2663S;3224;3224B;3224K;3224L;3224LB;3224LK;3227;3227L;3227B;3227K;3227L;3227LB;3227LK;3230;3230L;3230B;3230K;3230L;3230LB;3230LK;3232;3232L;3232B;3232K;3232L;3232LB;3232LK;3233;3233L;3233B;3233K;3233L;3233LB;3233LK;3235;3235L;3235B;3235K;3235L;3235LB;3235LK;3236;3236L;3236B;3236K;3236L;3236LB;3236LK;3240;3240L;3240B;3240K;3240L;3240LB;3240LK;3242;3242B;3242K;3242L;3242LB;3242LK;3243;3243B;3243K;3243L;3243LB;3243LK;3245) (4x2 & 4x4 & 6x4/4 & 6x4 & 6x2/4 & 6x2 & 6x6 & 8x4/4 & 8x4 & 8x2/4 & 8x8/4 & 8x6/4)
01.13-

KNORR SM7 AXIAL
(0°) POTENTIO.
CONTINU VIS

EFR7352

EFR7353

2924601
FCV4417PTS

KNORR SM7 AXIAL (-
12°) POTENTIO. AV/F
ON/OFF VIS

EFR7348

EFR7349

09.C311.10
FCR372A
93291200

WABCO MAXX 22L

EFR7010

EFR7011

2931501
29315FLE1749

22,5"

KNORR SL7 AXIAL (-
12°) POTENTIO.
CONTINU VIS

EFR7346

EFR7347

2924401
FCV4418PTS

KNORR SL7 AXIAL (-
12°) POTENTIO. AR/R
ON/OFF VIS

EFR7350

EFR7351

DF70000
09.B325.30
FCR145A
93087900

WABCO MAXX 22L

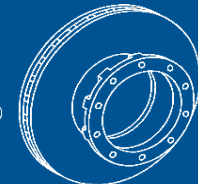
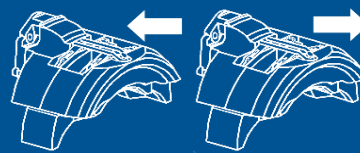
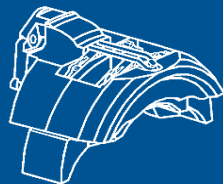
EFR7010

EFR7011

2931501
29315FLE1749

Automotive

APPLICATION PAR VEHICULES APPLICATION BY VEHICLES



MERCEDES (TRUCKS) ...

AROCS

(3245B;3245K;3245L;3245LB;3245LK;3246;3246B;3246K;3246L;3246LB;3246LK;3248;3248B;3248K;3248L;3248LB;3248LK;3251;3251B;3251K;3251L;3251LB;3251LK;3252;3252K;3252L;3252LK;3253;3253B;3253K;3253L;3253LB;3253LK;3258;3258K;3258L;3258LK;3263;3263K;3263L;3263LK;3324B;3327B;3330B;3332B;3332K;3333;3333A;3333AK;3333AS;3333B;3333K;3333L;3333LB;3333LK;3333LS;3333S;3335B;3335K;3336;3336A;3336AK;3336AS;3336B;3336K;3336L;3336LB;3336LK;3336LS;3336S;3340;3340A;3340AK;3340AS;3340B;3340K;3340L;3340LB;3340LK;3340LS;3340S;3342;3342A;3342AK;3342AS;3342B;3342K;3342L;3342LB;3342LK;3342LS;3342S;3343;3343A;3343AK;3343AS;3343B;3343K;3343L;3343LB;3343LK;3343LS;3343S;3345;3345L;3345A;3345AK;3345AS;3345B;3345K;3345L;3345LB;3345LK;3345LS;3345S;3346;3346A;3346AK;3346AS;3346B;3346K;3346L;3346LB;3346LK;3346LS;3346S;3348;3348A;3348AK;3348AS;3348B;3348K;3348L;3348LB;3348LK;3348LS;3348S;3351;3351A;3351AK;3351AS;3351B;3351K;3351L;3351LB;3351LK;3351LS;3351S;3352;3352A;3352AK;3352AS;3352K;3352L;3352LK;3352LS;3352S;3352SLT;3353;3353A;3353AK;3353AS;3353B;3353K;3353L;3353LB;3353LK;3353LS;3353S;3358;3358A;3358AK;3358AS;3358K;3358L;3358LK;3358LS;3358S;3358SLT;3363;3363A;3363AK;3363AS;3363K;3363L;3363LK;3363LS;3363S;3363SLT;4052SLT;4058SLT;4063SLT;4133;4133AK;4133B;4133K;4136;4136AK;4136B;4136K;4140;4140AK;4140B;4140K;4142;4142AK;4142B;4142K;4143;4143AK;4143B;4143K;4145;4145AK;4145B;4145K;4146;4146AK;4146B;4146K;4148;4148AK;4148B;4148K;4151;4151AK;4151B;4151K;4152;4152AK;4152K;4152SLT;4153;4153AK;4153B;4153K;4158;4158AK;4158K;4158SLT;4163;4163AK;4163K;4163SLT;4452SLT;4458SLT;4463SLT;4852SLT;4858SLT;4863SLT) (4x2 & 4x4 & 6x4/4 & 6x4 & 6x2/4 & 6x2 & 6x6 & 8x4/4 & 8x4 & 8x2/4 & 8x8/4 & 8x6/4) 01.13-

KNORR SM7 AXIAL
(0°) POTENTIO.
CONTINU VIS

EFR7352

EFR7353

TM
2924601
FCV4417PTS

KNORR SM7 AXIAL (-
12°) POTENTIO.
ON/OFF VIS

AV/F

EFR7348

EFR7349

09.C311.10
FCR372A
93291200

WABCO MAXX 22L

EFR7010

EFR7011

2931501
29315FLE1749

22,5"

KNORR SL7 AXIAL (-
12°) POTENTIO.
CONTINU VIS

EFR7346

EFR7347

2924401
FCV4418PTS

KNORR SL7 AXIAL (-
12°) POTENTIO.
ON/OFF VIS

AR/R

EFR7350

EFR7351

DF70000
09.B325.30
FCR145A
93087900

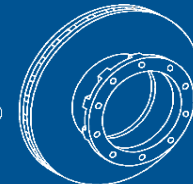
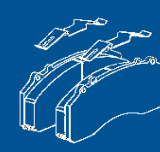
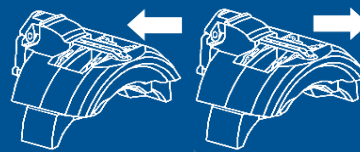
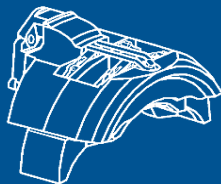
WABCO MAXX 22L

EFR7010

EFR7011

2931501
29315FLE1749

APPLICATION PAR VEHICULES
APPLICATION BY VEHICLES



MERCEDES (TRUCKS) ..!..

ECONIC (1823L; 1823LL; 1824L; 1824LL; 1828L; 1828LL; 1828LLS; 1828LS; 1829L; 1829LL; 1829LS; 1833L; 1833LL; 1833LS; 2624L; 2628L; 2628LL; 2629L; 2629LL; 2633L; 2633LL; 3233L; 3233LL) (4x2 & 6x2/4 & 6x4 & 8x4/4) 01.98-03.13

22,5" KNORR SB-SN7 AXIAL (-12°) POTENTIO. CONTINU

AV/F

EFR7304

EFR7305

2920200764

2927802

292530539

TM

DF70000
09.B325.30
FCR145A
93087900
ou/or
DF70008
09.A741.10
FCR323A
93186700

ECONIC 2 (1830LL; 1835LL; 2630LL; 2635LL) (4x2 & 6x2/4 & 6x4) 04.13-

22,5" WABCO MAXX 22L
KNORR SL7 AXIAL (-12°) POTENTIO. CONTINU VIS
KNORR SL7 AXIAL (-12°) POTENTIO. ON/OFF VIS

AR/R

EFR7010

EFR7011

2931501
29315FLE1749

EFR7346

EFR7347

2924401
FCV4418PTS

EFR7350

EFR7351

EFR7010

EFR7011

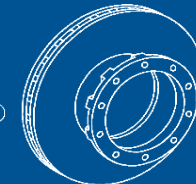
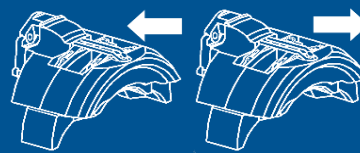
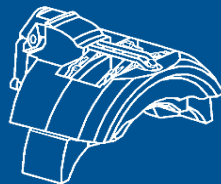
2931501
29315FLE1749

DF70000
09.B325.30
FCR145A
93087900

09.C311.10
FCR372A
93291200

DF70000
09.B325.30
FCR145A
93087900

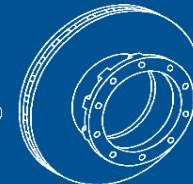
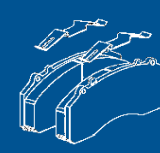
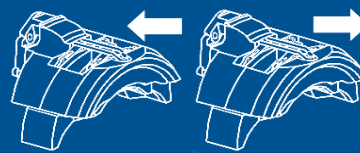
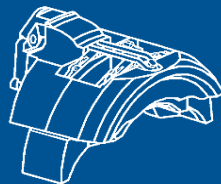
APPLICATION PAR VEHICULES APPLICATION BY VEHICLES



MERCEDES (TRUCKS) ..!..

ACCELO (710; 815; 914 C; 1016) (4x2) 10.98-	17,5"	KNORR SB-SN5 POTENTIO. CONTINU	AV/F	EFR5300	EFR5301	2918302	09.8574.10
		KNORR SB-SN5 POTENTIO. O/F		EFR5302	EFR5303		FCR186A
		KNORR SB-SN5 POTENTIO. CONTINU	AR/R	EFR5300	EFR5301		93101300
		KNORR SB-SN5 POTENTIO. O/F		EFR5302	EFR5303		
ATEGO (712; 714; 714K; 714L; 715; 715L; 717; 717K; 717L; 812; 814; 814K; 814L; 815; 815F; 815K; 815L; 817; 817K; 817L; 823; 823K; 823L; 914; 914K; 914L; 917; 917K; 917KO; 917L; 923; 923K; 923L; 1014; 1014K; 1014L; 1017; 1017K; 1017KO; 1017L; 1018KO; 1023; 1023K; 1023L; 1214; 1214L; 1217; 1217L; 1223; 1223L) (4x2) 01.98-10.04	17,5"	KNORR SB-SN5 POTENTIO. CONTINU	AV/F	EFR5300	EFR5301	2918302	09.8574.10
		KNORR SB-SN5 POTENTIO. O/F		EFR5302	EFR5303		FCR186A
		KNORR SB-SN5 POTENTIO. CONTINU	AR/R	EFR5300	EFR5301		93101300
		KNORR SB-SN5 POTENTIO. O/F		EFR5302	EFR5303		
ATEGO 2 (712; 713; 715; 715L; 716; 716L; 812; 812K; 813; 815; 815F; 815K; 815L; 816; 816K; 816L; 818; 818K; 818L; 822; 822F; 822K; 822L; 823; 823L; 824; 824K; 824L; 826; 826L; 829; 829L; 915; 915K; 915L; 916; 916K; 916L; 918; 918K; 918L; 922; 922K; 922L; 923; 923L; 924; 924K; 924L; 926; 926L; 929; 929L; 1015; 1015K; 1015L; 1016; 1016K; 1016L; 1017K; 1018; 1018K; 1018L; 1022; 1022K; 1022KO; 1022L; 1023; 1023L; 1024; 1024K; 1024L; 1026; 1026L; 1029; 1029L; 1215; 1215L; 1216; 1216L; 1218; 1218L; 1222; 1222L; 1223; 1223L; 1224; 1224L; 1226; 1226L; 1229; 1229L) (4x2) 10.04-03.13	17,5"	KNORR SB-SN5 POTENTIO. CONTINU	AV/F	EFR5300	EFR5301	2918302	09.8574.10
		KNORR SB-SN5 POTENTIO. O/F		EFR5302	EFR5303		FCR186A
		KNORR SB-SN5 POTENTIO. CONTINU	AR/R	EFR5300	EFR5301		93101300
		KNORR SB-SN5 POTENTIO. O/F		EFR5302	EFR5303		

APPLICATION PAR VEHICULES APPLICATION BY VEHICLES



MERCEDES (TRUCKS) .../..

ATEGO 3 (716; 716K; 716L; 718; 718K; 718L; 721; 721K; 721L; 723; 723K; 723L; 816; 816K; 816L; 818; 818K; 818L; 821; 821K; 821L; 823; 823K; 823L; 824; 824K; 824L; 827; 827K; 827L; 830; 830K; 830L; 916; 916F; 916K; 916L; 918; 918F; 918K; 918L; 921; 921F; 921K; 921L; 923; 923F; 923K; 923L; 924; 924F; 924K; 924L; 927; 927F; 927K; 927L; 930; 930F; 930K; 930L; 1016; 1016K; 1016KO; 1016L; 1018; 1018K; 1018KO; 1018L; 1021; 1021K; 1021KO; 1021L; 1023; 1023K; 1023KO; 1023L; 1024; 1024K; 1024L; 1027; 1027K; 1027L; 1030; 1030K; 1030L; 1216; 1216L; 1218; 1218L; 1221; 1221L; 1223; 1223L; 1224; 1224L; 1227; 1227L; 1230; 1230L; 2124; 2127; 2130) (4x2)04.13-

KNORR SB-SN5
POTENTIO. CONTINU

EFR5300

EFR5301

AV/F

TM

09.8574.10
FCR186A
93101300

KNORR SB-SN5
POTENTIO. O/F

EFR5302

EFR5303

17,5"

2918302

KNORR SB-SN5
POTENTIO. CONTINU

EFR5300

EFR5301

AR/R

09.9181.10
FCR187A
93102300

KNORR SB-SN5
POTENTIO. O/F

EFR5302

EFR5303

ATEGO (914; 914K; 914L; 917; 917K; 917KO; 917L; 923; 923K; 923L; 1014; 1014K; 1014L; 1017; 1017K; 1017KO; 1017L; 1018KO; 1023; 1023K; 1023L; 1214; 1214K; 1214L; 1215; 1215K; 1215L; 1217; 1217K; 1217KO; 1217L; 1223; 1223K; 1223L; 1225F; 1228; 1228L; 1317; 1317K; 1317KO; 1317L; 1317LKO; 1318KO; 1318LKO; 1323; 1323K; 1323KO; 1323L; 1323LKO; 1323LS; 1325F; 1328; 1328F; 1328L; 1328LS; 1517; 1517K; 1517L; 1523; 1523K; 1523KO; 1523L; 1528; 1528F; 1528K; 1528L; 1923L; 1928L; 2223L; 2228L) (4x2) 01.98-10.04

KNORR SB-SN6
AXIAL (5°+)
POTENTIO. CONTINU

EFR6306

EFR6307

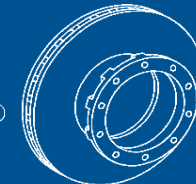
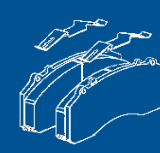
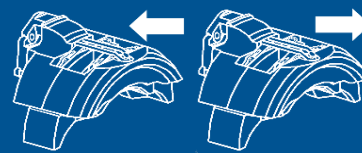
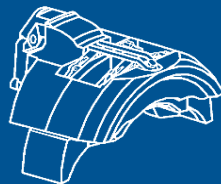
19,5"

2936101
CVP036K

AR/R

09.8925.10
FCR190A
93101500

APPLICATION PAR VEHICULES
APPLICATION BY VEHICLES



MERCEDES (TRUCKS) ..!..

ATEGO 2 (915; 915K; 915L; 916; 916K; 916L; 918; 918K; 918L; 922; 922K; 922L; 923; 923L; 924; 924K; 924L; 926; 926L; 929; 929L; 1015; 1015K; 1015L; 1016; 1016K; 1016L; 1017K; 1018; 1018K; 1018L; 1022; 1022K; 1022KO; 1022L; 1023; 1023L; 1024; 1024K; 1024L; 1026; 1026L; 1029; 1029L; 1215; 1215L; 1216; 1216K; 1216L; 1218; 1218K; 1218L; 1222; 1222F; 1222K; 1222L; 1223; 1223L; 1224; 1224K; 1224L; 1226; 1226F; 1226L; 1228; 1228L; 1229; 1229L; 1318; 1318A; 1318K; 1318L; 1322; 1322A; 1322F; 1322K; 1322L; 1322LKO; 1322LS; 1323; 1323A; 1323L; 1323LS; 1324; 1324A; 1324K; 1324L; 1324LKO; 1324LS; 1326; 1326F; 1326L; 1326LS; 1328; 1328L; 1328LS; 1329; 1329F; 1329L; 1329LS; 1518; 1518K; 1518L; 1522; 1522F; 1522K; 1522L; 1523; 1523K; 1523L; 1524; 1524K; 1524L; 1526; 1526K; 1526L; 1528; 1528L; 1529; 1529F; 1529K; 1529L; 1618; 1618K; 1622; 1622K; 1624; 1624K; 1629; 1924L; 1926L; 1929L; 2224L; 2226L; 2229L) (4x2 & 4x4 & 6x2/4)10.04-03.13

KNORR SB-SN6
19,5" AXIAL (5°+)
POTENTIO. O/F

AV/F

EFR6305

EFR6304

**2936101
CVP036K**

TM

**09.8573.10
FCR189A
93101400**

AR/R

**09.8925.10
FCR190A
93101500**

ATEGO 3 (1216K; 1218K; 1221F; 1221K; 1223F; 1223K; 1224F; 1224K; 1227F; 1227K; 1230F; 1230K; 1316; 1316K; 1316L; 1316LKO; 1318; 1318K; 1318L; 1318LKO; 1321; 1321F; 1321K; 1321L; 1321LKO; 1321LS; 1323; 1323F; 1323K; 1323L; 1323LKO; 1323LS; 1324; 1324F; 1324K; 1324L; 1324LKO; 1324LS; 1327; 1327F; 1327K; 1327L; 1327LKO; 1327LS; 1330; 1330F; 1330K; 1330L; 1330LKO; 1330LS; 1515L; 1516; 1516K; 1518; 1518K; 1518L; 1521; 1521K; 1521L; 1523; 1523K; 1523L; 1524; 1524F; 1524K; 1524L; 1527; 1527F; 1527K; 1527L; 1530; 1530F; 1530K; 1530L) (4x2) 04.13-

KNORR SB-SN6
19,5" AXIAL (5°+)
POTENTIO. O/F

AV/F

EFR6305

EFR6304

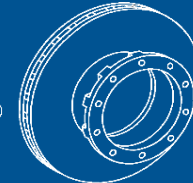
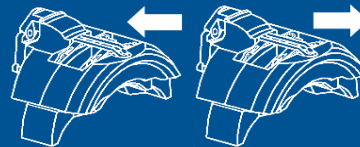
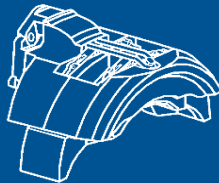
**2936101
CVP036K**

**09.8573.10
FCR189A
93101400**

AR/R

**09.8925.10
FCR190A
93101500**

APPLICATION PAR VEHICULES
APPLICATION BY VEHICLES



MERCEDES (TRUCKS) ..!..

ATEGO (1823; 1823K; 1823L; 1823LS; 1828; 1828K; 1828L; 1828LS; 2523L; 2528L; 2628; 2628B; 2628K) (4x2 & 6x2/4 & 6x2 & 6x4) 01.98-10.04

22,5" KNORR SB-SN7
AXIAL (-12°)
POTENTIO. CONTINU

AV/F

EFR7304

EFR7305

2920200764
2927801
292530539

TM

DF70000
09.B325.30
FCR145A
93087900
ou/or
DF70008
09.A741.10
FCR323A
93186700

ATEGO 2 (2529L) (6x2/4) 01.04-

22,5" KNORR SB-SN7
AXIAL (-12°)
POTENTIO. CONTINU

AV/F

EFR7304

EFR7305

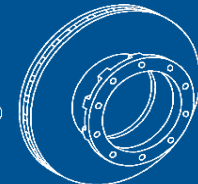
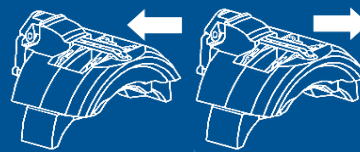
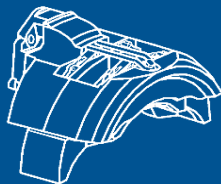
2920200764
2927801
292530539

DF70000
09.B325.30
FCR145A
93087900
ou/or
DF70008
09.A741.10
FCR323A
93186700

AR/R

DF70000
09.B325.30
FCR145A
93087900

APPLICATION PAR VEHICULES
APPLICATION BY VEHICLES



MERCEDES (TRUCKS) ..!..

AXOR (1823; 1823K; 1835LS; 1840LS; 1843LS; 2523; 2523K; 2528; 2535LS; 2540LS; 2543LS; 2623L; 2628B; 2628K; 2628L; 3228C) (4x2 & 6x2 & 8x2/4) 01.98-09.04

22,5" KNORR SB-SN7
AXIAL (-12°)
POTENTIO. CONTINU

AV/F

EFR7304

EFR7305

2920200764
2927801
292530539

DF70000
09.B325.30
FCR145A
93087900 ou/or
DF70008
09.A741.10
FCR323A
93186700

AR/R

AXOR 2 (1823; 1823K; 1823KL; 1823L; 1823LL; 1823LS; 1824; 1824K; 1824L; 1824LL; 1824LS; 1826; 1826K; 1826L; 1826LL; 1826LS; 1828; 1828K; 1828KL; 1828L; 1828LL; 1828LS; 1829; 1829K; 1829L; 1829LL; 1829LS; 1833; 1833K; 1833L; 1833LL; 1833LS; 1835LS; 1836LLS; 1836LS; 1840LLS; 1840LS; 1843LLS; 1843LS; 1933; 1933S; 2035LS; 2035S; 2036LS; 2036S; 2040LS; 2040S; 2041LS; 2041S; 2044S; 2436LS; 2440LS; 2443LS; 2523; 2528K; 2528KL; 2528L; 2529L; 2533; 2533L; 2535L; 2535LS; 2535S; 2536L; 2536LL; 2536LS; 2540L; 2540LL; 2540LS; 2540S; 2541LS; 2541S; 2543L; 2543LL; 2543LS; 2543S; 2544LS; 2544S; 2628; 2628B; 2628K; 2629; 2629B; 2629K; 2633; 2633B; 2633K; 2635B; 2636; 2636B; 2636K; 2640; 2640B; 2640K; 2640LS; 2640S; 2641LS; 2641S; 2643; 2643B; 2643K; 2644S; 2644LS; 3028B; 3028K; 3131; 3228; 3235; 3236B; 3236K; 3240; 3240B; 3240K; 3243; 3243B; 3243K; 3335; 3335B; 3335K; 3335S; 3340; 3340B; 3340K; 3340S; 3341; 3340S; 3341K; 3343; 3341S; 3343K; 3343; 3343B; 3343K; 3344; 3344K; 4135B; 4135K; 4140B; 4140K; 4143B; 4143K) (4x2 & 6x2 & 6x2/4 & 6x4 & 8x2/4 & 8x4 & 8x4/4) 10.04-

22,5" KNORR SB-SN7
AXIAL (-12°)
POTENTIO. CONTINU

AV/F

EFR7304

EFR7305

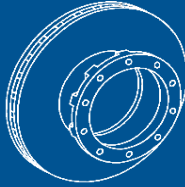
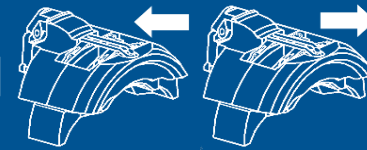
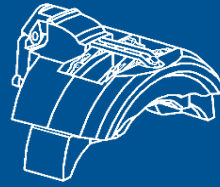
2920200764
2927801
292530539

DF70000
09.B325.30
FCR145A
93087900
DF70000
09.B325.30
FCR145A
93087900
ou/or
DF70008
09.A741.10
FCR323A
93186700

AR/R

DF70000
09.B325.30
FCR145A
93087900

APPLICATION PAR VEHICULES APPLICATION BY VEHICLES



MERCEDES (TRUCKS) ..!..

UNIMOG (U400; U423; U423L; U427; U427L; U430; U430L; U500; U527; U527L; U530; U530L; U4023; U5023) (4x4) 03.00-

19,5" WABCO 1300 V-G

AV/F

EFR6124

EFR6125

2913401

AR/R

TM

NEOPLAN/NEOMAN (CARS ET BUS)

CLUBSTAR (4x2) 05.98-

19,5" KNORR SB-SN6 AXIAL (5°+) POTENTIO. O/F

AV/F

EFR6304

EFR6305

2932002
CVP036K

CENTROLINER (N4407) Low Chassis/ Chassis bas 01.95-

19,5" WABCO 1600 V-G

AV/F

EFR5004

EFR5005

2907702

CENTROLINER (N4411; N4416; N4516) (4x2) 01.98-

22,5" KNORR SB-SN7 AXIAL (0°) POTENTIO. CONTINU VIS

AV/F

EFR7310

EFR7311

2920200764
2927802

W0310NE3
98032300

KNORR SB-SN7 AXIAL (0°) POTENTIO. CONTINU VIS

AR/R

EFR7310

EFR7311

292530539

KNORR SB-SN7 AXIAL (0°)

EFR7302

EFR7303

KNORR SB-SN7 AXIAL (0°) POTENTIO. CONTINU VIS

AV/F

EFR7302

EFR7303

EFR7310

EFR7311

CENTROLINER (N4420; N4421; N4522) (6x2) 01.98-

22,5" KNORR SB7 RADIAL (93°+)

AR/R2

EFR7314

EFR7315

2920200764
2927802

W0310NE3
98032300

KNORR SB7 RADIAL (93°+) POTENTIO. CONTINU VIS

EFR7316

EFR7317

292530539

KNORR SB-SN7 AXIAL (0°)

AR/R

EFR7302

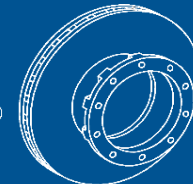
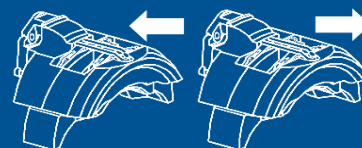
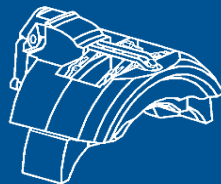
EFR7303

KNORR SB-SN7 AXIAL (0°) POTENTIO. CONTINU VIS

EFR7310

EFR7311

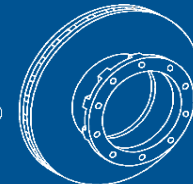
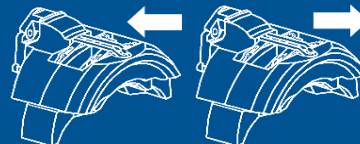
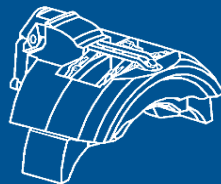
APPLICATION PAR VEHICULES APPLICATION BY VEHICLES



NEOPLAN/NEOMAN (CARS ET BUS)/

CENTROLINER (N4516T; N4522) (4x2 & 6x2) 01.03-	22,5"	MERITOR D ELSA 2	AV/F	EFR7700	EFR7701	2913103 CVP088K		
			AR/R2	EFR7718	EFR7719			
			AR/R	EFR7718	EFR7719			
CITYLINER (N116; N116/3HC; N122/3; N1216HD; N1216HDC) (4x2 & 6x2) 09.90-	22,5"	KNORR SB-SN7 AXIAL (0°)		EFR7302	EFR7303	2920200764 2927802 292530539	W0310NE3 98032300	FCR167A 93086700 ou/or 09.B325.40 FCR168A 93086800
			AV/F	EFR7310	EFR7311			
			AR/R	EFR7310	EFR7311			
			AR/R	EFR7310	EFR7311			
EUROLINER (N3316K; N3316KL; N3316Ü; N3316ÜL; N3318/3Ü) (4x2 & 6x2) 07.97-	22,5"	KNORR SB-SN7 AXIAL (0°)	AV/F	EFR7302	EFR7303	2920200764 2927802 292530539	W0310NE3 98032300	
			AR/R	EFR7302	EFR7303			
			AV/F	EFR7310	EFR7311			
LINIENBUS (Centroliner) (4x2) 01.98-	22,5"	KNORR SB-SN7 AXIAL (0°) KNORR SB7 RADIAL (93°+)		EFR7302	EFR7303	2920200764 2927802 292530539	W0310NE3 98032300	
			AV/F	EFR7310	EFR7311			
			AR/R	EFR7314	EFR7315			
			AR/R	EFR7316	EFR7317			

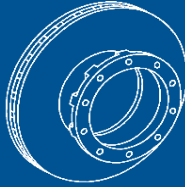
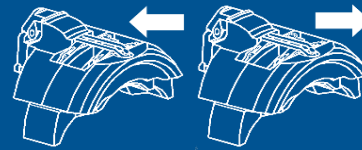
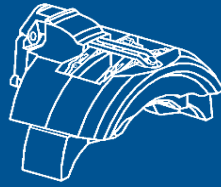
APPLICATION PAR VEHICULES
APPLICATION BY VEHICLES



NEOPLAN/NEOMAN (CARS ET BUS)/.

			KNORR SB-SN7 AXIAL (0°) POTENTIO. CONTINU VIS	AV/F	EFR7310	EFR7311		
LINIENBUS (Centroliner) (6x2) 01.98-	22,5"		KNORR SB7 RADIAL (93°+) POTENTIO. CONTINU VIS	AR/R2	EFR7316	EFR7317	2920200764 2927802 292530539	W0310NE3 98032300
			KNORR SB-SN7 AXIAL (0°) POTENTIO. CONTINU VIS	AR/R	EFR7310	EFR7311		
LINIENBUS (Centroliner) (6x2) 01.98-	22,5"		KNORR SB-SN7 AXIAL (0°)	AV/F	EFR7302	EFR7303	2920200764 2927802 292530539	W0310NE3 98032300
	22,5"		KNORR SB7 RADIAL (93°+)	AR/R2	EFR7314	EFR7315		
	22,5"		KNORR SB-SN7 AXIAL (0°)	AR/R	EFR7302	EFR7303		
SKYLINER (N122) (4x2) 09.90-	22,5"		KNORR SB-SN7 AXIAL (0°)		EFR7302	EFR7303	2920200764 2927802 292530539	W0310NE3 98032300
			KNORR SB-SN7 AXIAL (0°) POTENTIO. CONTINU VIS	AV/F	EFR7310	EFR7311		
			KNORR SB-SN7 AXIAL (0°)		EFR7302	EFR7303		
			KNORR SB-SN7 AXIAL (0°) POTENTIO. CONTINU VIS	AR/R	EFR7310	EFR7311		
							FCR167A 93086700 ou/or 09.B325.40 FCR168A 93086800	

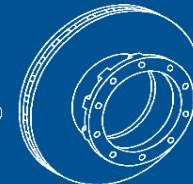
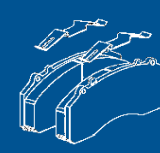
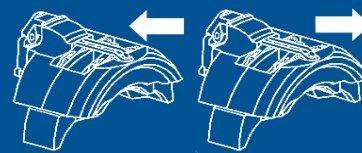
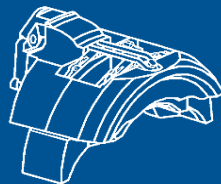
APPLICATION PAR VEHICULES
APPLICATION BY VEHICLES



NEOPLAN/NEOMAN (CARS ET BUS)/

			KNORR SB-SN7 AXIAL (0°)	AV/F	EFR7303	EFR7302			FCR167A 93086700
SKYLINER (N122/3; N122/3L) (6x2 & 6x2/4) 09.90-	22,5"	KNORR SB-SN7 AXIAL (0°) POTENTIO. CONTINU VIS	AR/R2				2920200764 2927802 292530539	W0310NE3 98032300	ou/or 09.B325.40 FCR168A 93086800
			AR/R	EFR7311	EFR7310				
STARLINER (N516; N2216SHD) (4x2) 09.96-	22,5"	KNORR SB-SN7 AXIAL (0°) POTENTIO. CONTINU VIS	AV/F	EFR7310	EFR7311			W0310NE3 98032300	
			KNORR SB-SN7 AXIAL (0°)		EFR7302	EFR7303	2920200764 2927802 292530539		
				AR/R	EFR7310	EFR7311			
			KNORR SB-SN7 AXIAL (0°) POTENTIO. CONTINU VIS		EFR7310	EFR7302			
STARLINER (N516/3; N2216SHD; N5218SHD) (6x2 & 6x2/4) 09.96-	22,5"	KNORR SB-SN7 AXIAL (0°) POTENTIO. CONTINU VIS	AV/F	EFR7303	EFR7302	2920200764 2927802 292530539	W0310NE3 98032300		
			AR/R2	EFR7311	EFR7310				
TOURLINER (N2216SHD) (4x2) 01.98-12.02	22,5"	MERITOR ELSA 1	AV/F	EFR7642	EFR7643	2911303	W0290MA1 98032400		
			AR/R	EFR7643	EFR7642				
TOURLINER (N2216SHD; N2216SHDL) (4x2 & 6x2) 01.03-	22,5"	KNORR SB-SN7	AV/F	EFR73XX	EFR73XX	2920200764 2927802 292530539	W0310NE3 98032300		
			AR/R						

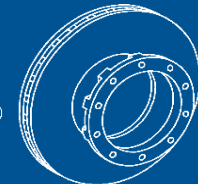
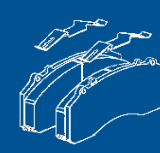
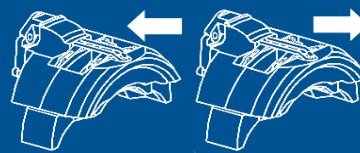
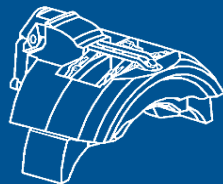
APPLICATION PAR VEHICULES
APPLICATION BY VEHICLES



NEOPLAN/NEOMAN (CARS ET BUS)/

			KNORR SB-SN7 AXIAL (0°) POTENTIO. CONTINU VIS	AV/F	EFR7310	EFR7311		
TRANSLINER (N314; N316) (4x2) 12.88-	22,5"		KNORR SB-SN7 AXIAL (0°)	AV/F	EFR7302	EFR7303	2920200764 2927802 292530539	W0310NE3 98032300
				AR/R				
			KNORR SB-SN7 AXIAL (0°) POTENTIO. CONTINU VIS	AR/R	EFR7310	EFR7311		
TRANSLINER (N316; N321/3) (6x2) 12.88-	22,5"		KNORR SB-SN7	AV/F	EFR73XX	EFR73XX	2920200764 2927802 292530539	W0310NE3 98032300
				AR/R2	EFR73XX	EFR73XX		
				AR/R2	EFR73XX	EFR73XX		
TRENDLINER (N3516Ü; N3516/3ÜL) (4x2 & 6x2) 09.04-	22,5"		KNORR SB-SN7 AXIAL (0°) POTENTIO. CONTINU VIS	AV/F	EFR7344	EFR7345	2920200764 2927801 292530539	W0310NE3 98032300
				AR/R	EFR7345	EFR7344		
NISSAN								
NT500 (75.18; 75.18 MTA) (4x2) 05.13-	17,5"		KNORR SB-SN5 POTENTIO. CONTINU	AV/F	EFR5300	EFR5301	2918302	
ECO-T (135.75; 135.80) (4x2) 01.98-12.00	19,5"		MERITOR C LISA	AV/F	EFR6654	EFR6655	2910004	
OTOKAR								
NAVIGO (F; SH) (4x2) 01.00-	17,5"		WABCO PAN 17	AV/F	EFR5006	EFR5007	2928504 CVP032K	
VECTIO (C) (4x2) 01.07-	19,5"		KNORR SB-SN6 AXIAL (5°+)	AV/F	EFR6300	EFR6301	2932002 CVP036K	

APPLICATION PAR VEHICULES
APPLICATION BY VEHICLES



RENAULT TRUCKS (CARS ET BUS)

AGORA (4x2 & 6x2) 01.95-12.96

22,5" MERITOR ELSA 1

AV/F

EFR7638

EFR7639

2903007
CVP013K
TM

W0365RT
98022800
ou/or
W0400RT
98031900

09.7870.10
FCR134A
93086100

AGORA (4x2 & 6x2) 01.97-12.00

22,5" MERITOR D LISA

AV/F

EFR7610

EFR7611

2909006
CVP023K

W0250RT
98025200

09.7870.10
FCR134A
93086100

RENAULT TRUCKS (TRUCKS)

MIDLINER (M150.12/C; M150.13/C; M180.12/C;
M180.13/C; M210.12/C; M210.13/C; M250.13/C;
M250.15/C; M250.15/D) (4x2) 01.98-01.00

19,5" MERITOR C LISA

AV/F

EFR6654

EFR6655

2910004

W0226RT1
98025100

MIDLUM (210.13/C; 210.14/C; 210.15/C; 210.16/C;
220.13/C; 220.13/D; 220.14/C; 220.14/D; 220.16/C;
220.16/D; 250.13/C; 250.14/C; 250.15/C; 250.16/C;
250.16/CT) (4x2) 01.00-01.02

19,5" MERITOR C LISA

AV/F

EFR6654

EFR6655

2910004

W0226RT1
98025100

MIDLUM (135.08/B; 135.09/B; 135.10/B; 150.08/B;
150.09/B; 150.10/B; 150.12/B; 180.08/B; 180.09/B;
180.10/B; 180.12; 180.12/B; 180.12/C; 210.08/B;
210.09/B; 210.10/B; 210.12/C; 220.08/B; 220.10/B;
220.12; 220.12/C; 250.12/C; 270.12/C) (4x2) 01.00-
04.06

17,5" WABCO PAN 17

AV/F

EFR5000

EFR5001

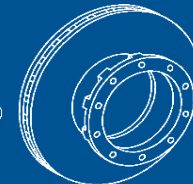
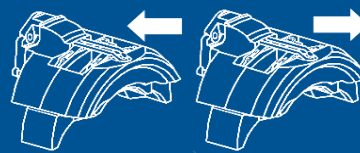
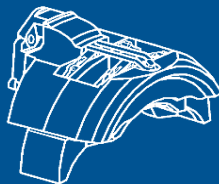
2928503
CVP032K

W0300B1
98024100

DF50001
09.9492.20
FCR218A
93192600
DF50002
09.9493.60
FCR219A
93192200

AR/R

APPLICATION PAR VEHICULES APPLICATION BY VEHICLES



RENAULT TRUCKS (TRUCKS)../..

MIDLUM (135.08/B; 135.09/B; 135.10/B; 150.08/B; 150.09/B; 150.10/B; 150.12/B; 180.08/B; 180.09/B; 180.10/B; 180.12; 180.12/B; 180.12/C; 210.08/B; 210.09/B; 210.10/B; 210.12/C; 220.08/B; 220.10/B; 220.12; 220.12/C; 250.12/C; 270.12/C) (4x2) 05.06-

17,5" WABCO PAN 17

AV/F

EFR5000

EFR5001

**2928503
CVP032K**

**W0300B1
98024100**

**DF50001
09.9492.20
FCR218A
93192600**

AR/R

**DF50003
09.9493.20**

MIDLUM (210.13/C; 210.14/C; 210.15/C; 210.16/C; 220.12; 220.13/C; 220.13/D; 220.14; 220.14/C; 220.14/D; 220.15; 220.16; 220.16/C; 220.16/D; 220.18/D; 250.13/C; 250.14/C; 250.15/C; 250.16/C; 250.16/CT; 270.13/C; 270.13/D; 270.14/C; 270.14/D; 270.16/B; 270.16/C; 270.16/D; 270.18/D) (4x2) 03.01-

19,5" WABCO PAN 19-2

AV/F

EFR6002

EFR6003

**29142
FCV1389**

**W0450RT1
98027500**

**FCR185A
93192000
ou/or
09.B845.20
FCR242A
93192400**

AR/R

**09.9496.10
FCR378A
93192500**

MIDLUM (160.10; 190.10; 220.10) (4x2) 05.06-

19,5" HALDEX DB 19

AV/F

EFR6200

EFR6200

**29181006042
918101**

W0365RT2

**DF60002
09.9494.40
FCR324A
93222700**

AR/R

**DF60001
09.9495.40
FCR325A
93192300**

MIDLUM (160.12; 190.12; 190.13; 190.14; 190.16; 220.13; 220.16; 240.12; 240.13; 240.14; 240.15; 240.16; 240.18; 280.12; 280.13; 280.14; 280.16; 280.18) (4x2) 05.06-

22,5" MERITOR ELSA 225-1
AXIAL

AV/F

**EFR7680
EFR7680R**

**EFR7681
EFR7681R**

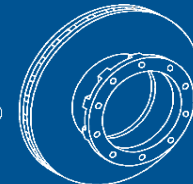
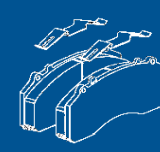
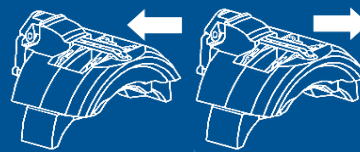
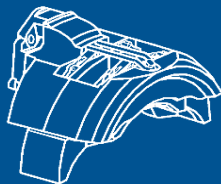
**2917300604
2917301
2927201**

**W0355RT1V2
98028200
WIK538**

**09.9497.10
FCR374A
09.9498.10
FCR375A**

AR/R

APPLICATION PAR VEHICULES APPLICATION BY VEHICLES



RENAULT TRUCKS (TRUCKS)..../..

D-Serie (10P210; 10P240; 12P210; 12P240; 12P250; 12P280; 13KP210; 13KP240; 13KP250; 13KP280; 13P210; 13P240; 13P250; 13P280; 14KP210; 14KP240; 14KP250; 14KP280; 14P210; 14P240; 14P250; 14P280; 16KP210; 16KP240; 16KP250; 16KP280; 16P210; 16P240; 16P250; 16P280; 18KP320; 18P320) (4x2) 01.13-

17,5" WABCO MAXX 17

AV/F

EFR5010

EFR5011

2928503
CVP032K

W0300B1
98024100

DF50001
09.9492.20
FCR218A
93192600

AR/R

EFR5012

EFR5013

DF50002
09.9493.60
FCR219A
93192200

D-Serie (12P210; 12P240; 12P250; 12P280) (4x2) 01.13-

19,5" WABCO MAXX 19

AV/F

EFR6012

EFR6013

2928401
CVP116K

W0335RT1
98065500

DF60002
09.9494.40
FCR324A
93222700

AR/R

EFR6014

EFR6015

DF60001
09.9495.40
FCR325A
93192300

D-Serie (12KP250; 12KP280; 13KP210; 13KP240; 13KP250; 13KP280; 13P210; 13P240; 13P250; 13P280; 14KP210; 14KP240; 14KP250; 14KP280; 14P210; 14P240; 14P250; 14P280; 16KP210; 16KP240; 16KP250; 16KP280; 16P210; 16P240; 16P250; 16P280; 18KP250; 18KP280; 18P250; 18P280; 18P320; 18P380; 18P430; 18T280; 18T320; 18T380; 18T430; 25P250; 25P280; 25P320; 26KP250; 26KP280; 26KP320; 26P250; 26P280; 26P320) (4x2 & 4x4 & 6x2) 01.13-

22,5" MERITOR ELSA 225-1
AXIAL

AV/F

EFR7680
EFR7680R

EFR7681
EFR7681R

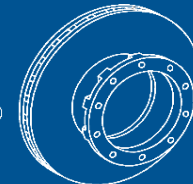
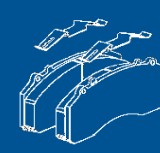
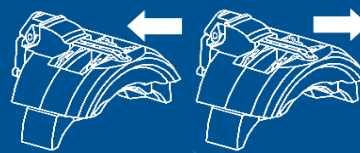
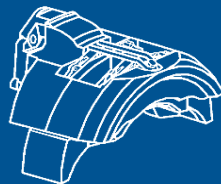
2917300604
2917301
2927201

W0355RT1V2
98028200
WIK538

09.A779.20

AR/R

APPLICATION PAR VEHICULES
APPLICATION BY VEHICLES



RENAULT TRUCKS (TRUCKS)..../.

D-Serie (12KP250; 12KP280; 13KP210; 13KP240; 13KP250; 13KP280; 13P210; 13P240; 13P250; 13P280; 14KP210; 14KP240; 14KP250; 14KP280; 14P210; 14P240; 14P250; 14P280; 16KP210; 16KP240; 16KP250; 16KP280; 16P210; 16P240; 16P250; 16P280; 18KP250; 18KP280; 18P250; 18P280; 18P320; 18P380; 18P430; 18T280; 18T320; 18T380; 18T430; 25P250; 25P280; 25P320; 26KP250; 26KP280; 26KP320; 26P250; 26P280; 26P320) (4x2 & 4x4 & 6x2) 01.13-

MERITOR ELSA 225-3
RADIAL

AV/F

EFR7676
EFR7676R

EFR7677
EFR7677R

2917400604
2917401
2927301

09.A779.20

MERITOR ELSA 225-1
AXIAL

AR/R2

EFR7680
EFR7680R

EFR7681
EFR7681R

2917300604
2917301
2927201

W0355RT1V2
98028200
WIK538

DF70010
FCR259A
93272000

ou/or

DF70009
FCR348A
93322700

MERITOR ELSA 225-3
AXIAL

AR/R

EFR7678
EFR7678R

EFR7679
EFR7679R

2917400604
2917401
2927301

22,5" MERITOR D2

AV/F

EFR7652

EFR7653

2904303

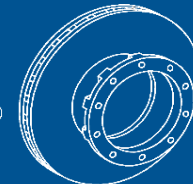
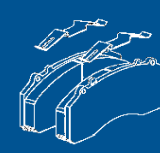
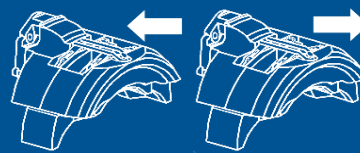
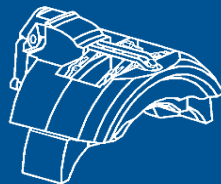
W0580RT
98028700

FCR128A
93086000

MAJOR (R340ti.16/T; R340ti.17; R340ti.18; R340ti.18/T; R340ti.19; R340ti.19/T; R340ti.24; R340ti.26; R350.17; R350.17/T; R350.18; R350.18/T; R350.19; R350.19/T; R350.19/TB; R350.24; R350.26; R380.17; R380.18; R380.18/T; R380.19; R380.19/T; R380.19/TB; R380.22/T; R380.24; R380.25; R380.25/T; R380.26; R380.26/T; R385ti.17; R385ti.18; R385ti.18/T; R385ti.19; R385ti.19/T; R385ti.22/T; R385ti.24; R385ti.25; R385ti.25/T; R385ti.26; R385ti.26/T; R420ti.18/T; R420ti.19/T; R420ti.22/T; R420ti.24/TS; R420ti.26/TS; R420ti.35/TS) (4x2 & 4x4 & 6x2 & 6x4) 05.91-10.93

Automotive

APPLICATION PAR VEHICULES
APPLICATION BY VEHICLES



RENAULT TRUCKS (TRUCKS)..../..

MAJOR (R340ti.16/T; R340ti.17; R340ti.18; R340ti.18/T;
R340ti.19; R340ti.19/T; R340ti.24; R340ti.26; R380.17;
R380.18; R380.18/T; R380.19; R380.19/T; R380.19/TB;
R380.24; R380.25; R380.25/T; R380.26; R380.26/T;
R385ti.17; R385ti.18; R385ti.18/T; R385ti.19;
R385ti.19/T; R385ti.22/T; R385ti.24; R385ti.25;
R385ti.25/T; R385ti.26; R385ti.26/T; R420ti.18/T;
R420ti.19/T; R420ti.22/T; R420ti.24/TS; R420ti.26/TS;
R420ti.35/TS) (4x2 & 4x4 & 6x2 & 6x4) 11.93-10.95

22,5" MERITOR D3

AV/F

EFR7602

EFR7603

TM
2903007
CVP013K

W0365RT
98022800

09.8059.20
FCR244A
93105000

MAJOR (R340ti.16/T; R340ti.17; R340ti.18; R340ti.18/T;
R340ti.19; R340ti.19/T; R340ti.24; R340ti.26; R380.17;
R380.18; R380.18/T; R380.19; R380.19/T; R380.19/TB;
R380.24; R380.25; R380.25/T; R380.26; R380.26/T;
R385ti.17; R385ti.18; R385ti.18/T; R385ti.19;
R385ti.19/T; R385ti.22/T; R385ti.24; R385ti.25;
R385ti.25/T; R385ti.26; R385ti.26/T; R420ti.18/T;
R420ti.19/T; R420ti.22/T; R420ti.24/TS; R420ti.26/TS;
R420ti.35/TS) (4x2 & 4x4 & 6x2 & 6x4) 11.95-10.96

22,5" MERITOR D3

AV/F

EFR7602

EFR7603

2903007
CVP013K

W0400RT
98031900

09.8059.20
FCR244A
93105000

MAGNUM (AE380; AE380.19TD; AE380.22TD; AE385ti;
AE500; AE500.19TD; AE500.22TD) (4x2) 01.90-12.92

22,5" MERITOR D2

AV/F

EFR7652

EFR7653

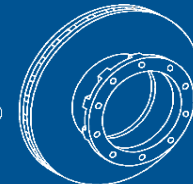
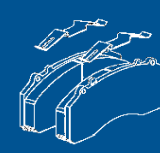
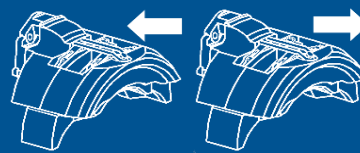
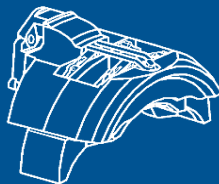
2904303

W0580RT
98028700

FCR128A
93086000

Automotive

APPLICATION PAR VEHICULES
APPLICATION BY VEHICLES



RENAULT TRUCKS (TRUCKS)../..

MAGNUM (AE385ti.18; AE385ti.18T; AE385ti.19;
AE385ti.19T; AE385ti.24; AE385ti.26; AE420ti.18;
AE420ti.18T; AE420ti.19; AE420ti.19T; AE420ti.22T;
AE420ti.24; AE420ti.24T; AE420ti.26; AE420ti.26T;
AE520.18; AE520.18T; AE520.19; AE520.19T;
AE520.22T; AE520.24; AE520.24T; AE520.26;
AE520.26T) (4x2 & 6x2) 02.92-12.96

22,5" MERITOR D3

AV/F

EFR7602

EFR7603

**2903007
CVP013K**

**W0360RT
98025500**

**09.8059.20
FCR244A
93105000**

MAGNUM (AE390.18; AE390.18T; AE390.19;
AE390.19T; AE390.26; AE430.18; AE430.18T;
AE430.19; AE430.19T; AE430.26; AE430.26T;
AE430.26T; AE470.18; AE470.18T; AE470.19;
AE470.19T; AE470.26; AE470.26T; AE560.18;
AE560.18T; AE560.19; AE560.19T; AE560.26;
AE560.26T) (4x2 & 6x2) 04.96-12.96

22,5" MERITOR D3

AV/F

EFR7602

EFR7603

**2903007
CVP013K**

**W0400RT
98031900**

**09.8059.20
FCR244A
93105000**

MAGNUM (AE385ti.18; AE385ti.18T; AE385ti.19;
AE385ti.19T; AE385ti.24; AE385ti.26; AE420ti.18;
AE420ti.18T; AE420ti.19; AE420ti.19T; AE420ti.22T;
AE420ti.24; AE420ti.24T; AE420ti.26; AE420ti.26T;
AE520.18; AE520.18T; AE520.19; AE520.19T;
AE520.22T; AE520.24; AE520.24T; AE520.26;
AE520.26T) (4x2 & 6x2 & 6x4) 02.92-07.95

22,5" MERITOR D LISA

AV/F

EFR7610

EFR7611

**2909006
CVP023K**

**W0250RT
98025200**

**09.7870.10
FCR134A
93086100**

MAGNUM (AE390.18; AE390.18T; AE390.19;
AE390.19T; AE390.26; AE430.18; AE430.18T;
AE430.19; AE430.19T; AE430.26; AE430.26T;
AE470.18; AE470.18T; AE470.19; AE470.19T;
AE470.26; AE470.26T; AE560.18; AE560.18T;
AE560.19; AE560.19T; AE560.26; AE560.26T) (4x2 &
6x2 & 6x4) 04.96-05.00

22,5" MERITOR D LISA

AV/F

EFR7610

EFR7611

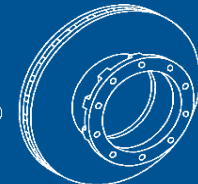
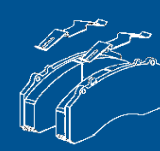
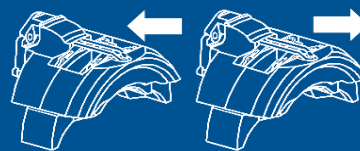
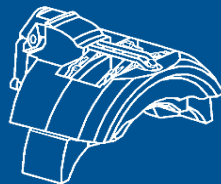
**2909006
CVP023K**

**W0250RT
98025200**

**09.7870.10
FCR134A
93086100**

Automotive

APPLICATION PAR VEHICULES APPLICATION BY VEHICLES



RENAULT TRUCKS (TRUCKS)..

MAGNUM (AE390.18; AE390.18T; AE390.19; AE390.19T; AE390.26; AE430.18; AE430.18T; AE430.19; AE430.19T; AE430.26; AE430.26T; AE470.18; AE470.18T; AE470.19; AE470.19T; AE470.26; AE470.26T; AE560.18; AE560.18T; AE560.19; AE560.19T; AE560.26; AE560.26T) (4x2 & 6x2 & 6x4) 06.00-09.04

22,5" MERITOR D ELSA 2

AV/F

EFR7658

EFR7659

2913105
CVP088K

W0355RT1V1
98027600

09.8059.20
FCR244A
93105000

MAGNUM E-TECH (400.18; 400.18T; 400.24; 400.26; 440.18; 440.18T; 440.24; 440.26; 440.26T; 480.18; 480.18T; 480.24; 480.26; 480.26T) (4x2 & 6x2 & 6x4) 06.00-09.04

22,5" MERITOR D ELSA 2

AV/F

EFR7658

EFR7659

2913105
CVP088K

W0355RT1V1
98027600

09.8059.20
FCR244A
93105000

AR/R

EFR7660

EFR7661

W0355RT1V1
98027600

08.8060.10
FCR245A
93105100

MERITOR ELSA 225-3
RADIAL

AV/F

EFR7676
EFR7676R

EFR7677
EFR7677R

2917400604
2917401
2927301

DF70010
FCR259A
93272000
ou/or **DF70005**
FCR249A
93272100

MERITOR ELSA 225-3
AXIAL

AV/F

EFR7678
EFR7678R

EFR7679
EFR7679R

MAGNUM Dxi 12 (440.18; 440.18T; 440.24; 440.26; 440.26T; 480.18; 480.18T; 480.24; 480.26; 480.26T) (4x2 & 6x2 & 6x4) 10.04-04.06

22,5"

MERITOR VGT 195
(Essieu
relevable/Lifting Axle)

AR/R2

EFR6600

EFR6601

2917705
CVP095K

W0355RT1V2
98028200
WIK538

DF70011
09.E451.10
FCR328A
93322800

MERITOR ELSA 225-3
RADIAL

AR/R2

EFR7676
EFR7676R

EFR7677
EFR7677R

2917400604
2917401
2927301

DF70010
FCR259A
93272000
ou/or

MERITOR ELSA 225-3
AXIAL

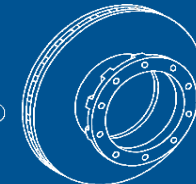
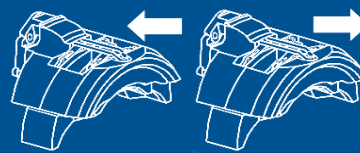
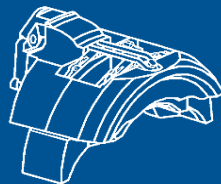
AR/R

EFR7678
EFR7678R

EFR7679
EFR7679R

DF70009
FCR348A
93322700

APPLICATION PAR VEHICULES APPLICATION BY VEHICLES



RENAULT TRUCKS (TRUCKS)..../..

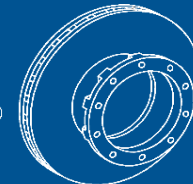
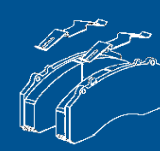
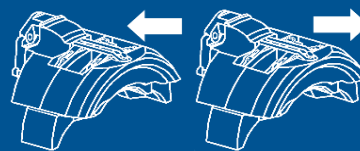
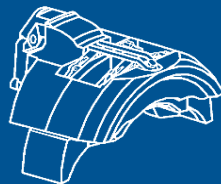
MAGNUM DXi 13 (440.19; 460.18T; 460.24; 460.25; 460.26; 460.26T; 480.19; 480.26; 500.18T; 500.24; 500.25; 500.26; 500.26T; 520.18; 520.19; 520.24; 520.25; 520.26) (4x2 & 6x2) 05.06-

MERITOR ELSA 225-3 AXIAL	AV/F	EFR7678 EFR7678R	EFR7679 EFR7679R	2917400604 2917401 2927301		DF70010 FCR259A 93272000 ou/or DF70005 FCR249A 93272100
MERITOR VGT 195 (Essieu relevable/Lifting Axle)	AR/R2	EFR6600	EFR6601	2917705 CVP095K	W0355RT1V2 98028200 WIK538	DF70011 09.E451.10 FCR328A 93322800
MERITOR ELSA 225-3 RADIAL	AR/R2	EFR7676 EFR7676R	EFR7677 EFR7677R	2917400604 2917401 2927301		DF70010 FCR259A 93272000 ou/or DF70009 FCR348A 93322700
MERITOR ELSA 225-3 AXIAL	AR/R	EFR7678 EFR7678R	EFR7679 EFR7679R			

PREMIUM Distribution & Route (210.16; 210.18D; 210.19D; 220.18; 250.16; 250.18D; 250.19; 260.16; 260.18; 260.19; 300.16; 300.16D; 300.16T; 300.18; 300.18D; 300.18D/T; 300.18T; 300.19; 300.19D/T; 300.19T; 300.26D; 340.18; 340.18D; 340.18D/T; 340.18T; 340.19; 340.19D; 340.19D/T; 340.19T; 340.24; 340.26; 340.26D; 385.18; 385.18T; 385.19; 385.19T; 385.24; 385.24T; 385.26; 400.18; 400.18D/T; 400.18T; 400.19; 400.19T; 400.24; 400.24T; 400.26) (4x2 & 6x2 & 6x2/4) 04.96-06.98

MERITOR D 3	AV/F			2903007 CVP013K	W0400RT 98031900	09.8059.20 FCR244A 93105000
MERITOR D 3	AR/R	EFR7602	EFR7603			08.8060.10 FCR245A 93105100

APPLICATION PAR VEHICULES APPLICATION BY VEHICLES



RENAULT TRUCKS (TRUCKS)..../.

PREMIUM Distribution & Route (210.16; 210.18D; 210.19D; 220.18; 250.16; 250.18D; 250.19; 260.16; 260.18; 260.19; 300.16; 300.16D; 300.16T; 300.18; 300.18D; 300.18D/T; 300.18T; 300.19; 300.19D/T; 300.19T; 300.26D; 340.18; 340.18D; 340.18D/T; 340.18T; 340.19; 340.19D; 340.19D/T; 340.19T; 340.24; 340.26; 340.26D; 385.18; 385.18T; 385.19; 385.19T; 385.24; 385.24T; 385.26; 400.18; 400.18D/T; 400.18T; 400.19; 400.19T; 400.24; 400.24T; 400.26) (4x2 & 6x2 & 6x2/4) 07.98-07.00

22,5" MERITOR D LISA

AV/F

EFR7610

EFR7611

TM
2909006
CVP023K

W0226RT1
98025100

09.7870.10
FCR134A
93086100

AR/R

PREMIUM Distribution & Route (210.16; 210.18D; 210.19D; 220.18; 250.16; 250.18D; 250.19; 260.16; 260.18; 260.19; 270.18; 300.16; 300.16D; 300.16T; 300.18; 300.18D; 300.18D/T; 300.18T; 300.19; 300.19D/T; 300.19T; 300.26D; 320.18; 320.18D; 320.24D; 320.26D; 340.18; 340.18D; 340.18D/T; 340.18T; 340.19; 340.19D; 340.19D/T; 340.19T; 340.24; 340.26; 340.26D; 370.18; 370.18D; 370.24; 370.24D; 370.26; 370.26D; 385.18; 385.18T; 385.19; 385.19T; 385.24; 385.24T; 385.26; 400.18; 400.18D/T; 400.18T; 400.19; 400.19T; 400.24; 400.24T; 400.26; 420.18; 420.18D; 420.18T; 420.24; 420.25; 420.26) (4x2 & 6x2 & 6x2/4) 08.00-09.05

22,5" MERITOR D ELSA 2

AV/F

EFR7668

EFR7669

2913105
CVP088K

W0355RT1V1
98027600

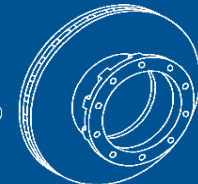
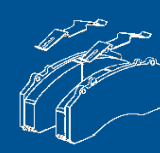
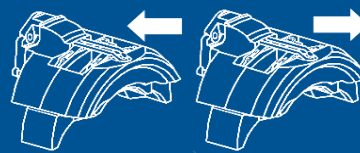
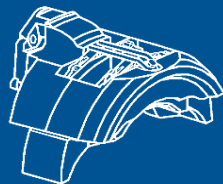
09.A779.20

AR/R

08.8060.10
FCR245A
93105100

Automotive

APPLICATION PAR VEHICULES APPLICATION BY VEHICLES



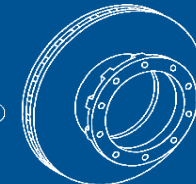
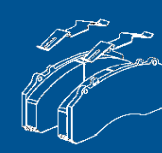
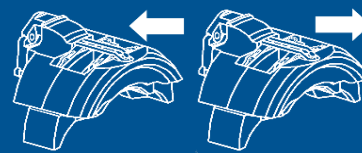
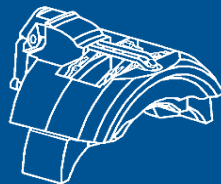
RENAULT TRUCKS (TRUCKS)../..

PREMIUM 2 Distribution & Lander & Route (240.18D;
270.18; 270.19; 280.18D; 280.26; 310.18; 310.19;
310.26; 320.18; 320.18D; 320.26; 330.18T; 340.18;
340.19; 340.26; 370.18D; 370.26; 380.18; 380.19;
380.26; 380.32; 410.18; 410.18D; 410.24; 410.25;
410.26; 430.18; 430.19; 430.26; 430.32; 440.18; 440.19;
440.26; 440.32; 450.18; 450.18D; 450.24; 450.25;
450.26; 460.18; 460.19; 460.26; 460.32) (4x2 & 6x2 &
6x2/4 & 6x4 & 8x4) 10.05-

22,5"	MERITOR ELSA 225-3 AXIAL	AV/F	EFR7678 EFR7678R	EFR7679 EFR7679R	2917400604 2917401 2927301	W0355RT1V2 98028200 WIK538	DF70010 FCR259A 93272000 ou/or DF70005 FCR249A 93272100
19,5"	MERITOR VGT 195 (Essieu relevable/Lifting Axle)	AR/R2	EFR6600	EFR6601	2917705 CVP095K	W0355RT1V2 98028200 WIK538	DF70011 09.E451.10 FCR328A 93322800
22,5"	MERITOR ELSA 225-3 RADIAL	AR/R	EFR7676 EFR7676R	EFR7677 EFR7677R	2917400604 2917401 2927301	W0355RT1V2 98028200 WIK538	DF70010 FCR259A 93272000 ou/or DF70009 FCR348A 93322700
22,5"	MERITOR ELSA 225-3 AXIAL	AR/R	EFR7678 EFR7678R	EFR7679 EFR7679R	2917300604 2917301 2927201	W0355RT1V2 98028200 WIK538	DF70010 FCR259A 93272000 ou/or DF70009 FCR348A 93322700
22,5"	MERITOR ELSA 225-1 AXIAL	AR/R	EFR7680 EFR7680R	EFR7681 EFR7681R	2917300604 2917301 2927201	W0355RT1V2 98028200 WIK538	DF70010 FCR259A 93272000 ou/or DF70009 FCR348A 93322700

PREMIUM 2 (27RC; 29CB/CG/RB/RG) (4x2) 01.05-

APPLICATION PAR VEHICULES APPLICATION BY VEHICLES



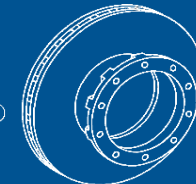
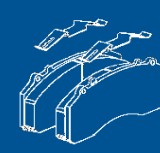
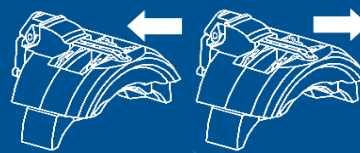
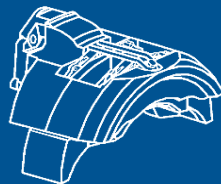
RENAULT TRUCKS (TRUCKS)..../..

C-Serie (250P; 250PK; 280P; 280PK; 320P; 320PK; 380P; 380PK; 380PXLOAD; 380T; 380TK; 430P; 430PK; 430PXLOAD; 430T; 430TK; 440P; 440PK; 440T; 440TK; 460P; 460PK; 460PXLOAD; 460T; 460TK; 480P; 480PK; 480T; 480TK; 520P; 520PK; 520T; 520TK) (4x2 & 6x2 & 6x2/4 & 6x4 & 6x6 & 8x4/4) 01.13-

22,5"	MERITOR ELSA 225-3 RADIAL	AV/F	EFR7676 EFR7676R	EFR7677 EFR7677R	2917400604 2917401 2927301		09.A779.20
19,5"	MERITOR VGT 195 (Essieu relevable/Lifting Axle)	AR/R2	EFR6600	EFR6601	2917705 CVP095K	W0355RT1V2 98028200 WIK538	DF70011 09.E451.10 FCR328A 93322800 DF70010 FCR259A 93272000 ou/or DF70009 FCR348A 93322700
22,5"	MERITOR ELSA 225-3 AXIAL	AR/R	EFR7678 EFR7678R	EFR7679 EFR7679R	2917400604 2917401 2927301		DF70010 FCR259A 93272000
	MERITOR ELSA 225-3 RADIAL	AV/F	EFR7676 EFR7676R	EFR7677 EFR7677R			DF70010 FCR259A 93272000
22,5"	MERITOR ELSA 225-3 AXIAL	AR/R	EFR7678 EFR7678R	EFR7679 EFR7679R	2917400604 2917401 2927301	W0355RT1V2 98028200 WIK538	DF70010 FCR259A 93272000 ou/or DF70009 FCR348A 93322700

K-Serie (380P; 380T; 430P; 430T; 440P; 440T; 460P; 460T; 480P; 480T; 520P; 520T; HEAVY; MEDIUM; XTREM) (4x2 & 4x4 & 6x4 & 6x6 & 8x4/4) 01.13-

APPLICATION PAR VEHICULES
APPLICATION BY VEHICLES



RENAULT TRUCKS (TRUCKS)..../..

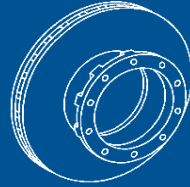
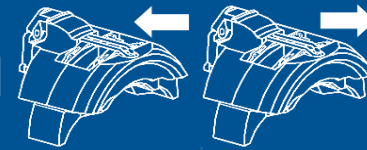
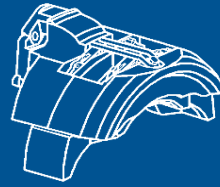
	MERITOR ELSA 225-3 RADIAL	AV/F	EFR7676 EFR7676R	EFR7677 EFR7677R	2917400604 2917401 2927301		09.A779.20
						TM	DF70010 FCR259A 93272000 ou/or DF70009 FCR348A 93322700
T-Serie (380P; 380PLOW; 380T; 380TLOW; 380TLOW; 380TPUS; 380TTAG; 380TX-LOW; 430P; 430PLOW; 430T; 430TLOW; 430TPUS; 430TTAG; 430TX-LOW; 440P; 440PLOW; 440T; 440TLOW; 440TPUS; 440TTAG; 440TX-LOW; 4460TX-LOW; 460P; 460PLOW; 460T; 460TLOW; 460TPUS; 460TTAG; 480P; 480PLOW; 480T; 480TLOW; 480TPUS; 480TTAG; 480TX-LOW; 520P; 520PLOW; 520T; 520TLOW; 520TLOW; 520TPUS; 520TTAG; 520TX- LOW) (4x2 & 6x2 & 6x2/4) 01.13-	22,5" MERITOR ELSA 225-1 AXIAL	AR/R2	EFR7680 EFR7680R	EFR7681 EFR7681R	2917300604 2917301 2927201		DF70011 09.E451.10 FCR328A 93322800
	19,5" MERITOR VGT 195 (Essieu relevable/Lifting Axle)		EFR6600	EFR6601	2917705 CVP095K	W0355RT1V2 98028200 WIK538	DF70010 FCR259A 93272000 ou/or DF70005 FCR249A 93272100
	22,5" MERITOR ELSA 225-3 AXIAL	AR/R	EFR7678 EFR7678R	EFR7679 EFR7679R	2917400604 2917401 2927301		

Automotive

ROR (AXLE)

LM & TA (M20) 02.00-01.02	22,5" MERITOR D DUCO AXIAL		EFR7630	EFR7631	2927705 CVP037K		
LM & TA (M18) 01.02-	22,5" MERITOR D DUCO AXIAL		EFR7616	EFR7617	2927705 CVP037K		

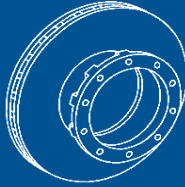
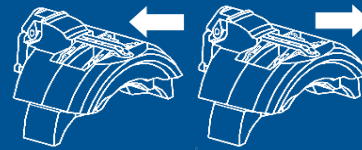
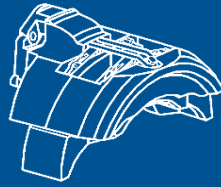
**APPLICATION PAR VEHICULES
APPLICATION BY VEHICLES**



ROR (AXLE)..../.

LM (disque 8 trous/disc 8 holes ABS+) 01.98-	19,5" MERITOR DX 195	EFR6650	EFR6651	2912405 CVP024K	W0290RO 98034500	09.E166.10 FCR347A
LM (disque 8 trous/disc 8 holes) 01.98-	19,5" MERITOR DX 195	EFR6650	EFR6651	2912405 CVP024K	W0290RO 98034500	FCR248A 93127900
LM (disque 10 trous/disc 10 holes ABS+) 01.98-	19,5" MERITOR DX 195	EFR6650	EFR6651	2912405 CVP024K	W0290RO 98034500	09.8979.10 FCR223A 93117700
LM & LC (disque 8 trous/disc 8 holes ABS+) 01.03-06.04	19,5" MERITOR ELSA 195 LE	EFR6602	EFR6603	2917705 CVP095K	W0760BP 98028900	09.E166.10 FCR347A
LM & LC (disque 8 trous/disc 8 holes) 01.03-06.04	19,5" MERITOR ELSA 195 LE	EFR6602	EFR6603	2917705 CVP095K	W0760BP 98028900	FCR248A 93127900
LM & LC (disque 10 trous/disc 10 holes ABS+) 01.03-06.04	19,5" MERITOR ELSA 195 LE	EFR6602	EFR6603	2917705 CVP095K	W0760BP 98028900	09.8979.10 FCR223A 93117700
LM 07.01-	22,5" MERITOR ELSA 2	EFR7692	EFR7693	2913105 CVP088K		
TA 07.01-	22,5" MERITOR ELSA 2	EFR7692	EFR7693	2913105 CVP088K		
TM (disque 8 trous/disc 8 holes ABS+) 01.98-	19,5" MERITOR DX 195	EFR6650	EFR6651	2912405 CVP024K	W0290RO 98034500	09.E166.10 FCR347A
TM (disque 8 trous/disc 8 holes) 01.98-	19,5" MERITOR DX 195	EFR6650	EFR6651	2912405 CVP024K	W0290RO 98034500	FCR248A 93127900
TM (disque 10 trous/disc 10 holes ABS+) 01.03-06.04	19,5" MERITOR ELSA 195 LE	EFR6602	EFR6603	2917705 CVP095K	W0760BP 98028900	09.8979.10 FCR223A 93117700
TM (disque 8 trous/disc 8 holes ABS+) 01.03-06.04	19,5" MERITOR ELSA 195 LE	EFR6602	EFR6603	2917705 CVP095K	W0760BP 98028900	09.E166.10 FCR347A

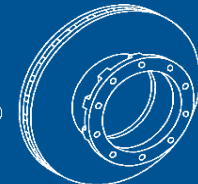
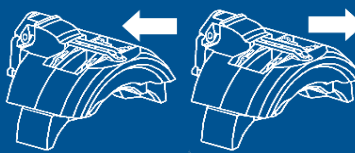
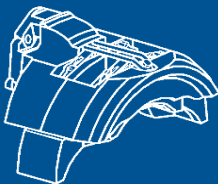
APPLICATION PAR VEHICULES
APPLICATION BY VEHICLES



ROR (AXLE)..../.

TM (disque 8 trous/disc 8 holes) 01.03-06.04	19,5"	MERITOR ELSA 195 LE	EFR6602	EFR6603	2917705 CVP095K	W0760BP 98028900	FCR248A 93127900
TRAXX KÖGEL (TA; LM; LMC) (ABS+) 01.03-06.04	22,5"	MERITOR ELSA 225L-2 AXIAL	EFR7704	EFR7705	2921101		09.8579.10 FCR250A 93192700
SAF (AXLE)							
B (B9-22; BI9-22; BL9-22; BIL9-22; BINL9-22) 01.05-	22,5"	KNORR SK7	EFR6308	EFR6309	2926900604 2926901 292570539		09.E162.10 FCR358A 93308700
SK (9019; 11019W Intradisc plus) (Etrier 6 trous/Caliper 6 holes) 01.98-	19,5"	WABCO PAN 19-1 Plus	EFR6006	EFR6007	2931302	W0760SA	09.8556.10 FCR204A 93105600
SK (9019; 11019W Intradisc plus) (Etrier 4 trous/Caliper 4 holes) 01.98-	19,5"	WABCO PAN 19-1 Plus	EFR6010	EFR6011	2931302	W0760SA	09.8556.10 FCR204A 93105600
SK (9019; 11019K) 01.98-	19,5"	KNORR SB-SN6 AXIAL (5°+)	EFR6300	EFR6301	2932004 CVP036K	W0360SA 98028800	09.8367.10 FCR202A 93101700
SKRB (SKRB 9019 KI Integral; WI Integral)	19,5"	KNORR SB-SN6 AXIAL (5°+)	EFR6300	EFR6301	2932004 CVP036K	W0940SABP	09.E156.10 93193400
SKRB (SKRB 9022 KI Integral; WI Integral)	22,5"	KNORR SB-SN7 AXIAL (0°)	EFR7302	EFR7303	2920200764 2927801 292530539	W0940SABP	09.E155.10 93193500
SK (9022; 11222K) 01.98-	22,5"	KNORR SB-SN7 AXIAL (0°)	EFR7302	EFR7303	2920200764 2927801 292530539	W0940SABP	09.8368.10 FCR203A 93101900

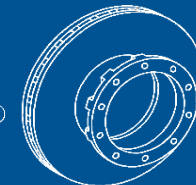
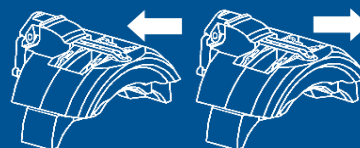
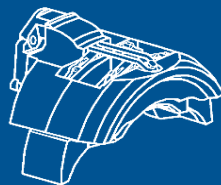
APPLICATION PAR VEHICULES
APPLICATION BY VEHICLES



SAF (AXLE)../..

SK (9022; 11222K) 01.98-	22,5" KNORR SB-SN7 AXIAL (0°) POTENTIO. CONTINU VIS	EFR7310	EFR7311	2920200764 2927801 292530539	W0940SABP	09.8368.10 FCR203A 93101900
SK (9022; 11222K) 01.98-	22,5" KNORR SB-SN7 AXIAL (-12°)	EFR7300	EFR7301	2920200764 2927801 292530539	W0940SABP	09.8368.10 FCR203A 93101900
SBS (1918HO) 06.15-	19,5" HALDEX DBT 19LT	EFR6202	EFR6203	29xxxxx	W0610SA	FCR373A 09.E163.10
SBS (2220HO) 01.12-	22,5" HALDEX DBT 22LT	EFR7206	EFR7207	29175 FCV4420B	W0610SA	
SBS (2220KO) 01.15-	22,5" KNORR ST7 AXIAL (0°)	EFR7354	EFR7355	2931801 FCV4725PTS		09.E164.20
SK RB (9022H) 01.98-	22,5" HALDEX DB 22	EFR7209	EFR7209	2914302		09.8793.10 FCR201A 93101800
SK RB (9022K) 01.08-	22,5" KNORR SK7	EFR6308	EFR6309	2926900604 2926901 292570539		
SK RB (9022W) 01.05-	22,5" WABCO PAN 22-1	EFR7002	EFR7003	2933601		
SK RS (9022; 11222K) 01.08-	22,5" KNORR SK7	EFR6308	EFR6309	2926900604 2926901 292570539		
SK RS (9022; 11222W) 01.05-	22,5" WABCO PAN 22-1	EFR7002	EFR7003	2933601		
SK RZ (9022; 11222K) 01.08-	22,5" KNORR SK7	EFR6308	EFR6309	2926900604 2926901 292570539		
SK RZ (9022; 11222W) 01.05-	22,5" WABCO PAN 22-1	EFR7002	EFR7003	2933601		

APPLICATION PAR VEHICULES APPLICATION BY VEHICLES

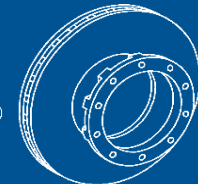
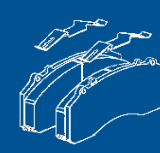
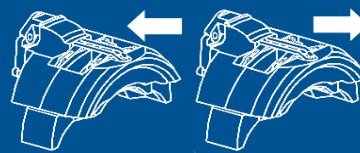
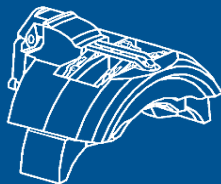


SCANIA (CARS ET BUS)

4 SERIES BUS (K; L; N) -12.04

		KNORR SB-SN7 AXIAL (0°)		EFR7302	EFR7303			
		KNORR SB-SN7 AXIAL (0°) (Essieu/Axle AMA; AMI)		EFR7303	EFR7302			
			AV/F				TM	
	22,5"	KNORR SB-SN7 AXIAL (0°) POTENTIO. CONTINU VIS (Essieu/Axle AMA; AMI)		EFR7311	EFR7310	2920200764 2927802 292530539	W0310SV4 98025400	DF70003 09.A995.10 FCR170A 93088300
		KNORR SB7 RADIAL (86°+) (Essieu directionnel/Steering axle)	AR/R2	EFR7307	EFR7306			
		KNORR SB7 RADIAL (93°+) (Essieu/Axle ZF)		EFR7315	EFR7314			
		KNORR SB-SN7 AXIAL (0°)	AR/R	EFR7302	EFR7303			
K SERIES (K230C; K250IB; K250UB; K270 Ethanol; K270C Ethanol; K280C; K310IA; K310IB; K310UB; K320C; K360IB; K400IB; K440IB) (4x2 & 6x2 & 6x2/4 & 6x2/2/4 & 8x2) 01.06-	22,5"	KNORR SN7	AV/F	EFR73XX	EFR73XX	2920200764 2927802 292530539	W0310SV4 98025400	DF70003 09.A995.10 FCR170A 93088300
			AR/R	EFR73XX	EFR73XX			
SERIES (94CL/230 Ethanol; 94CL/300) (4x2 & 6x2 & 6x2/4) 01.05-09.10	22,5"	KNORR SB-SN7 AXIAL (0°)	AV/F	EFR7303	EFR7302	2920200764 2927802	W0310SV4 98025400	DF70003 09.A995.10
			AR/R					
		KNORR SB-SN7 AXIAL (R86°+) POTENTIO.	AV/F	EFR7335	EFR7334	2920200764 2927802 292530539	W0310SV4 98025400	DF70003 09.A995.10 FCR170A 93088300
SERIES (94CL/230 Ethanol; 94CL/300) (4x2 & 6x2 & 6x2/4) 01.05-09.10	22,5"	CONTINU CLIP						
		KNORR SB-SN7 AXIAL (0°) POTENTIO. CONTINU CLIP	AR/R	EFR7321	EFR7320			

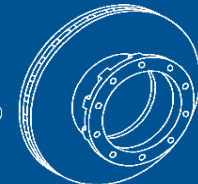
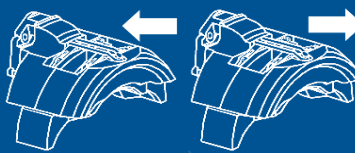
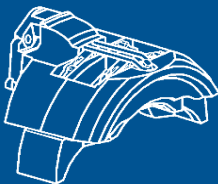
APPLICATION PAR VEHICULES APPLICATION BY VEHICLES



SCANIA (CARS ET BUS)/.

SERIES (94CL/230 Ethanol; 94CL/300) (4x2 & 6x2 & 6x2/4) 01.05-09.10	22,5"	KNORR SB7 RADIAL (86°+)	AV/F						
	22,5"	KNORR SB7 RADIAL (86°+) (Essieu directionnel/Steering axle)		EFR7307	EFR7306	2920200764	W0310SV4	DF70003	09.A995.10
						2927802	98025400	FCR170A	93088300
	22,5"	KNORR SB7 RADIAL (93°+) POTENTIO. CONTINU CLIP (Essieu/Axle ZF)	AR/R	EFR7322	EFR7323	292530539			
CITYWIDE 01.11-	22,5"	KNORR SB-SN7 AXIAL (0°)	AV/F	EFR7303	EFR7302	2920200764	W0310SV4	DF70003	09.A995.10
						2927802	98025400	FCR170A	93088300
IRIZAR (EBS+) 05.97-	22,5"	KNORR SB-SN7 AXIAL (0°) POTENTIO. CONTINU VIS	AV/F	EFR7311	EFR7310	2920200764	W0310SV4	DF70003	09.A995.10
						2927802	98025400	FCR170A	93088300
IRIZAR (EBS-) -12.04	22,5"	KNORR SB-SN7 AXIAL (0°)	AV/F	EFR7303	EFR7302	2920200764	W0310SV4	DF70003	09.A995.10
						2927802	98025400	FCR170A	93088300
IRIZAR 01.17-	22,5"	KNORR SB-SN7 AXIAL (0°) POTENTIO. O/F	AR/R	EFR7308	EFR7309	2933100604	W0310SV4	DF70003	09.A995.10
						2933102	98025400	FCR170A	93088300

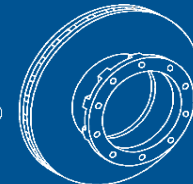
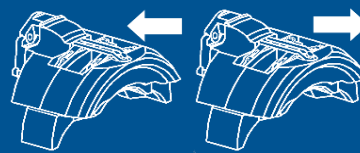
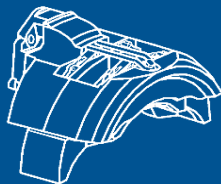
**APPLICATION PAR VEHICULES
APPLICATION BY VEHICLES**



SCANIA (CARS ET BUS)/.

				KNORR SB-SN7 AXIAL (0°)		EFR7302	EFR7303			
				KNORR SB-SN7 AXIAL (0°) POTENTIO. CONTINU VIS	AV/F	EFR7311	EFR7310			
				KNORR SB-SN7 AXIAL (0°) (Essieu/Axle AMA; AMI)		EFR7303	EFR7302			
OMNICITY -12.04	22,5"			KNORR SB7 RADIAL (86°+) (Essieu directionnel/Steering axle)	AR/R2	EFR7307	EFR7306	2920200764 2927802 292530539	W0310SV4 98025400	DF70003 09.A995.10 FCR170A 93088300
				KNORR SB-SN7 AXIAL (0°)	AR/R	EFR7302	EFR7303			
				KNORR SB7 RADIAL (93°+)	AR/R	EFR7315	EFR7314			
				KNORR SB-SN7 22,5" AXIAL (0°) POTENTIO. CONTINU CLIP	AV/F	EFR7321	EFR7320	2920200764 2927802 292530539		
OMNICITY S 01.09-				KNORR SB7 RADIAL 22,5" (93°+) POTENTIO. CONTINU CLIP	AR/R	EFR7322	EFR7323	2920200764 2927802 292530539 2933100604 2933102	W0310SV4 98025400	DF70003 09.A995.10 FCR170A 93088300
								2920200764 2927802 292530539		
OMNILINK 01.05-	22,5"			KNORR SB-SN7 AXIAL (0°)	AV/F	EFR7303	EFR7302	2920200764 2927802 292530539 2933100604 2933102	W0310SV4 98025400	DF70003 09.A995.10 FCR170A 93088300
								01.09-12.15 01.16-		

APPLICATION PAR VEHICULES APPLICATION BY VEHICLES



SCANIA (TRUCKS)

SERIE 4 (94/G260; 94C/260; 94C/300; 94C/310; 94D/220; 94D/230; 94D/260; 94D/270; 94D/300; 94D/310; 94G/220; 94G/260; 94G/310; 94L/310; 114C/330; 114C/340; 114C/360; 114C/380; 114G/330; 114G/340; 114G/380; 114L/340; 114L/380; 124/G420; 124C/360; 124C/400; 124C/420; 124C/470; 124G/360; 124G/400; 124G/420; 124G/470; 124L/360; 124L/400; 124L/420; 124L/440; 124L/470; 144C/460; 144C/530; 144G/460; 144G/530; 144L/460; 144L/530; 164C/480; 164C/580; 164G/480; 164G/580; 164L/480; 164L/580; T94C/260; T94C/310; T94G/220; T94G/230; T94G/260; T94G/310; T94L/310; T114C/340; T114C/380; T114G/340; T114G/380; T114L/340; T114L/380; T124C/360; T124C/400; T124C/420; T124G/360; T124G/400; T124G/420; T124L/360; T124L/400; T124L/420; T124L/470; T144C/460; T144C/530; T144G/460; T144G/530; T144L/460; T144L/530) (4x2 & 6x2 & 4x4 & 6x2 & 6x2/2 & 6x2/4 & 6x2/2/4 & 6x4 & 6x6 & 8x2 & 8x2/4/6 & 8x2/6 & 8x4 & 8x4/4) 05.95-

KNORR SB-SN7
AXIAL (0°) AV/F

22,5"

KNORR SB-SN7
AXIAL (0°) (Essieu
Directionnel/Steering
axle) AR/R2

KNORR SB-SN7
AXIAL (0°) AR/R

EFR7303

EFR7302

2920200764
2927801
292530539
05.95-12.15
2933100604
2933101
01.16-

W0310SV4
98025400

DF70003
09.A995.10
FCR170A
93088300

SERIE 4 (94/G260; 94C/260; 94C/300; 94C/310; 94D/220; 94D/230; 94D/260; 94D/270; 94D/300; 94D/310; 94G/220; 94G/260; 94G/310; 94L/310; 114C/330; 114C/340; 114C/360; 114C/380; 114G/330; 114G/340; 114G/380; 114L/340; 114L/380; 124/G420; 124C/360; 124C/400; 124C/420; 124C/470; 124G/360; 124G/400; 124G/420; 124G/470; 124L/360; 124L/400; 124L/420; 124L/440; 124L/470; 144C/460; 144C/530; 144G/460; 144G/530; 144L/460; 144L/530; 164C/480; 164C/580; 164G/480; 164G/580; 164L/480; 164L/580; T94C/260; T94C/310; T94G/220; T94G/230; T94G/260; T94G/310; T94L/310; T114C/340; T114C/380; T114G/340; T114G/380; T114L/340; T114L/380; T124C/360; T124C/400; T124C/420; T124G/360; T124G/400; T124G/420; T124L/360; T124L/400; T124L/420; T124L/470; T144C/460; T144C/530; T144G/460; T144G/530; T144L/460; T144L/530) (4x2 & 6x2 & 4x4 & 6x2 & 6x2/2 & 6x2/4 & 6x2/2/4 & 6x4 & 6x6 & 8x2 & 8x2/4/6 & 8x2/6 & 8x4 & 8x4/4) 05.95-

KNORR SB-SN7
RADIAL (86°+)
POTENTIO. CONTINU
VIS AV/F

22,5"

KNORR SB-SN7
AXIAL (0°) POTENTIO.
CONTINU VIS (Essieu
directionnel/Steering
axle) AR/R2

EFR7311

EFR7310

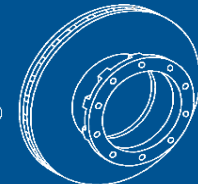
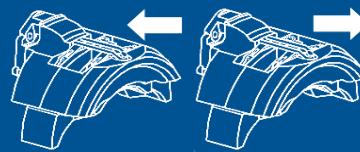
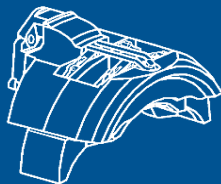
2920200764
2927801
292530539
05.95-12.15
2933100604
2933101
01.16-

W0310SV4
98025400

DF70003
09.A995.10
FCR170A
93088300

KNORR SB-SN7
AXIAL (0°) POTENTIO.
CONTINU VIS AR/R

APPLICATION PAR VEHICULES APPLICATION BY VEHICLES



SCANIA (TRUCKS) ..I..

SERIE 4 (94/G260; 94C/260; 94C/300; 94C/310; 94D/220; 94D/230; 94D/260; 94D/270; 94D/300; 94D/310; 94G/220; 94G/260; 94G/310; 94L/310; 114C/330; 114C/340; 114C/360; 114C/380; 114G/330; 114G/340; 114G/380; 114L/340; 114L/380; 124/G420; 124C/360; 124C/400; 124C/420; 124C/470; 124G/360; 124G/400; 124G/420; 124G/470; 124L/360; 124L/400; 124L/420; 124L/440; 124L/470; 144C/460; 144C/530; 144G/460; 144G/530; 144L/460; 144L/530; 164C/480; 164C/580; 164G/480; 164G/580; 164L/480; 164L/580; T94C/260; T94C/310; T94G/220; T94G/230; T94G/260; T94G/310; T94L/310; T114C/340; T114C/380; T114G/340; T114G/380; T114L/340; T114L/380; T124C/360; T124C/400; T124C/420; T124G/360; T124G/400; T124G/420; T124L/360; T124L/400; T124L/420; T124L/470; T144C/460; T144C/530; T144G/460; T144G/530; T144L/460; T144L/530) (4x2 & 6x2 & 4x4 & 6x2 & 6x2/2 & 6x2/4 & 6x2/2/4 & 6x4 & 6x6 & 8x2 & 8x2/4/6 & 8x2/6 & 8x4 & 8x4/4) 05.95-

KNORR SB-SN7 AXIAL
(0°) POTENTIO. AV/F
CONTINU CLIP

22,5" KNORR SB-SN7 AXIAL
(0°) POTENTIO. AR/R2
CONTINU CLIP (Essieu
Directionnel/Steering
axle)

KNORR SB-SN7 AXIAL
(0°) POTENTIO. AR/R
CONTINU CLIP

KNORR SB-SN7
RADIAL (86°+)
POTENTIO. CONTINU AV/F
VIS

22,5" KNORR SB-SN7
AXIAL (0°) POTENTIO. AR/R2
CONTINU VIS (Essieu
directionnel/Steering
axle)

KNORR SB-SN7
AXIAL (0°) POTENTIO. AR/R
CONTINU VIS

2920200764
2927801
292530539
05.95-12.15
2933100604
2933101
01.16-

W0310SV4
98025400

DF70003
09.A995.10
FCR170A
93088300

EFR7325 **EFR7324**

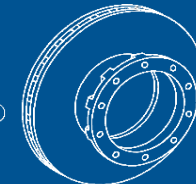
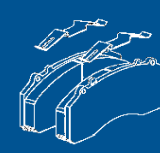
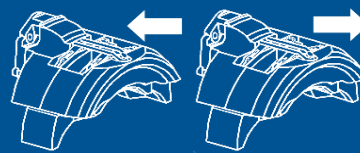
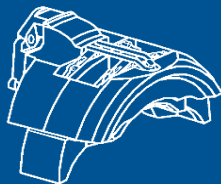
2920200764
2927801
292530539
05.95-12.15
2933100604
2933101
01.16-

W0310SV4
98025400

DF70003
09.A995.10
FCR170A
93088300

EFR7311 **EFR7310**

APPLICATION PAR VEHICULES
APPLICATION BY VEHICLES



SCANIA (TRUCKS) ..!..

SERIE P, R, G, T (G230; G270; G310; G340; G360; G380; G400; G410; G420; G440; G450; G470; G480; G490; P230; P250; P260; P270; P280; P300; P310; P320; P340; P360; P370; P380; P400; P410; P420; P440; P450; P470; P480; P500; P550; P560; P580; P620; R230; R270; R310; R340; R360; R380; R400; R410; R420; R440; R450; R470; R480; R490; R500; R520; R560; R580; R620; R730; T470) (4x2 & 4x4 & 6x2 & 6x2/4 & 6x2/2/4 & 6x4 & 6x6 & 8x2 & 8x2/4 & 8x2/6 & 8x4 & 8x4/4 & 8x8 & 10x4/6) 01.03-

KNORR SB-SN7 AXIAL
(0°) POTENTIO. AV/F
CONTINU CLIP

22,5" KNORR SB-SN7 AXIAL
(0°) POTENTIO. AR/R2
CONTINU CLIP (Essieu Directionnel/Steering axle)

KNORR SB-SN7 AXIAL
(0°) POTENTIO. AR/R
CONTINU CLIP

2920200764
2927801
292530539
05.95-12.15
2933100604
2933101
01.16-

W0310SV4
98025400

DF70003
09.A995.10
FCR170A
93088300

SCHMITZ (TRAILER)

BRAKE WABCO WH. 19.5" 01.98-

19,5" WABCO PAN 19-1 Plus

EFR6006

EFR6007

2931302

W0760SA

09.8556.10
FCR204A
93105600

BRAKE WABCO WH. 22.5" 01.05-

22,5" WABCO PAN 22-1

EFR7002

EFR7003

2933601

SC TRAILER AXLE 07.13-

22,5" WABCO MAXX 22T

EFR70xx

EFR70xx

2933606

RTOS 06.06-

22,5" KNORR SB-SN7 AXIAL (-12°)

EFR7301

EFR7300

2920200764
2927801
292530539

09.9406.20
FCR336A
93296100

BRAKE KNORR WH. 22.5" 01.08-

22,5" KNORR SK7

EFR6308

EFR6309

2926900604
2926901
292570539

SBS 2220 KO (Essieu/Axle SAF) 10.15-

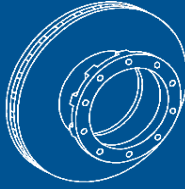
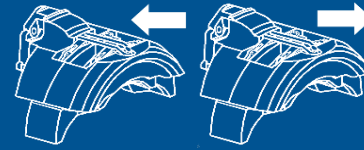
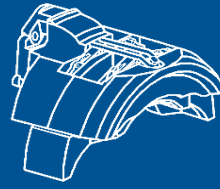
22,5" KNORR ST7 AXIAL (0°)

EFR7354

EFR7355

2932801
FCV4736PTS

APPLICATION PAR VEHICULES
APPLICATION BY VEHICLES



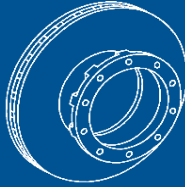
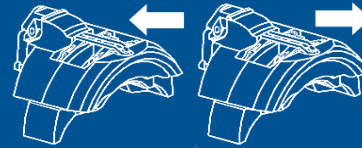
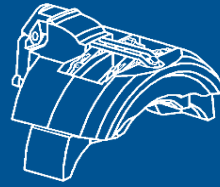
SMB (AXLE)

BRAKE KNORR WH. 19.5" 01.98-	19,5"	KNORR SB-SN6 AXIAL (5°+)		EFR6300	EFR6301	2932004 CVP036K	09.8543.10 FCR200A 93193600
BRAKE KNORR WH. 22.5" 02.98-	22,5"	KNORR SB-SN7 AXIAL (-12°)		EFR7300	EFR7301	2920200764 2927801 292530539	09.8526.10 FCR199A 93102000
BRAKE KNORR WH. 22.5" 01.00-	22,5"	KNORR SB-SN7 AXIAL (-12°) POTENTIO. CONTINU		EFR7304	EFR7305	2920200764 2927801 292530539	09.8526.10 FCR199A 93102000
HALDEX DB22LT 01.06-	22,5"	HALDEX DB 22 LT		EFR7204	EFR7204	29175 FCV4420B	FCR362A
HALDEX MARK 3 (6 trous/Holes) 10.00-	22,5"	HALDEX DB 22		EFR7200	EFR7200	2914302	09.8526.10 FCR199A 93102000
HALDEX MARK 4 (6 trous/Holes) 11.01-	22,5"	HALDEX DB 22		EFR7201	EFR7201	2914302	09.8526.10 FCR199A 93102000
WABCO PAN 22 01.00-	22,5"	WABCO PAN 22-2		EFR7000	EFR7001	29154xx	09.8526.10 FCR199A 93102000

SOLARIS (BUS)

ALPINO (4x2) 01.07-		KNORR SB-SN7 AXIAL (0°)	AV/F	EFR7303	EFR7302	2920200764 2927802 292530539	09.B325.40 FCR168A 93086800
	22,5"	KNORR SB7 RADIAL (93°+) POTENTIO. CONTINU VIS	AR/R	EFR7317	EFR7316		

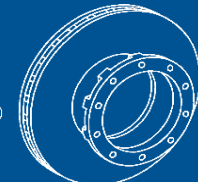
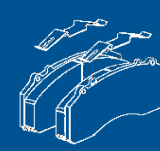
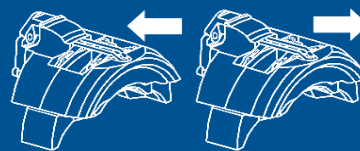
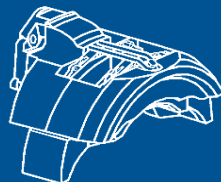
APPLICATION PAR VEHICULES
APPLICATION BY VEHICLES



SOLARIS (BUS)/.

URBINO (9; 10; 12; 15; 18) (4x2 & 6x2) 01.99-	22,5"	KNORR SB-SN7 AXIAL (0°)	AV/F	EFR7303	EFR7302	2920200764	09.B325.40
		KNORR SB7 RADIAL (93°+) POTENTIO. CONTINU VIS	AR/R	EFR7317	EFR7316	2927802 292530539	FCR168A 93086800
VACANZA (12; 13) (4x2 & 6x2) 06.02-	22,5"	KNORR SB-SN7 AXIAL (0°)	AV/F	EFR7303	EFR7302	2920200764	09.B325.40
		KNORR SB7 RADIAL (93°+) POTENTIO. CONTINU VIS	AR/R	EFR7317	EFR7316	2927802 292530539	FCR168A 93086800
TEMSA							
AVENUE 01.08-	17,5"	WABCO PAN 17	AV/F	EFR5006	EFR5007	2928504	CVP032K
			AR/R				
BOX 01.98-	22,5"	KNORR SB-SN7 AXIAL (-12°) POTENTIO. CONTINU	AV/F	EFR7304	EFR7305	2920200764	2927802 292530539
			AR/R				
DIAMOND (14) (6x2) 01.06-	22,5"	MERITOR ELSA 1	AV/F	EFR7638	EFR7639	2911307	
			AR/R				
OPALIN (8) 01.01-	17,5"	WABCO PAN 17	AV/F	EFR5006	EFR5007	2928504	CVP032K
			AR/R				
SAFARI 01.99-	22,5"	MERITOR ELSA 1	AV/F	EFR7632	EFR7633	2911303	
			AR/R				
SAFARI (HD) 01.98-	22,5"	KNORR SB-SN7 AXIAL (-12°) POTENTIO. CONTINU	AV/F	EFR7304	EFR7305	2920200764	2927802 292530539
			AR/R				
SAFARI (INTERCITY) 01.99-	22,5"	MERITOR ELSA 1	AV/F	EFR7646	EFR7647	2911303	
			AR/R				

APPLICATION PAR VEHICULES
APPLICATION BY VEHICLES



TVM

MARBUS B3 (090TH; 090TL; 090TLL) (4x2) 01.01-	19,5"	KNORR SB-SN6 AXIAL (5°+)	AV/F	EFR6300	EFR6301	2932002 CVP036K
MARBUS B4 (080) (4x2) 01.01-	17,5"	WABCO PAN 17	AV/F AR/R	EFR5006	EFR5007	2928504 CVP032K

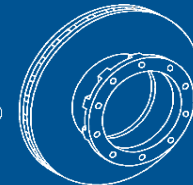
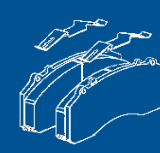
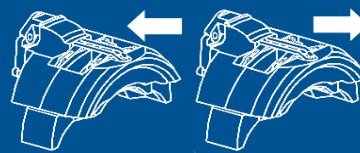
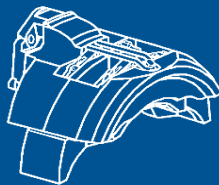
VALX

BRAKE WABCO WH. 19.5" 01.98-	19,5"	WABCO PAN 19-1 Plus		EFR6006	EFR6007	2931302 W0760SA
BRAKE WABCO WH. 22.5" 01.05-	22,5"	WABCO PAN 22-1		EFR70xx	EFR70xx	2933601

VAN HOOL (CARS ET BUS)

900 & T2100 (MAN Axle) 01.97-12.98	22,5"	MERITOR D3	AV/F AR/R	EFR7600	EFR7601	2911307 W0400MA1 98024300
A SERIE (A308; A320; A330; AG300; AG330) (4x2 & 6x2) 01.06-	22,5"	MERITOR ELSA 1	AV/F AR/R	EFR7696 EFR7638	EFR7697 EFR7639	2911307 W0400MA1 98024300
A SERIE (A330 Chassis MAN) (4x2) -12.02	22,5"	MERITOR ELSA 1	AV/F AR/R	EFR7642 EFR7643	EFR7643 EFR7642	2911307 W0400MA1 98024300
ALPANO; ASTRON (T917) (6x2) 01.99-	22,5"	MERITOR ELSA 1	AV/F AR/R2 AR/R	EFR7696 EFR7697 EFR7636	EFR7697 EFR7696 EFR7637	2911307 W0400MA1 98024300
ASTROMEGA (T924; T927) (4x2) 01.00-	22,5"	MERITOR ELSA 2 MERITOR D ELSA 2	AV/F AR/R	EFR7702 EFR7718	EFR7703 EFR7719	2913105 CVP088K
BUS (Essieux/Axle ZF) (4x2) 01.00-	22,5"	MERITOR ELSA 2	AV/F AR/R	EFR7720	EFR7721	2913105 CVP088K
INTERCITY (913CL; 915CL; 918CL) (4x2) 01.00-	22,5"	MERITOR ELSA 2 MERITOR D ELSA 2	AV/F AR/R	EFR7702 EFR7718	EFR7703 EFR7719	2913105 CVP088K

APPLICATION PAR VEHICULES
APPLICATION BY VEHICLES



VAN HOOL (CARS ET BUS) ..!..

T SERIE (T911; 916; 917; 918) (4x2) 01.00-

22,5"	MERITOR ELSA 2	AV/F	EFR7702	EFR7703	2913105
	MERITOR D ELSA 2	AR/R	EFR7718	EFR7719	CVP088K

VDL

CITEA (CLF; SLF) (4x2) 01.99-

22,5"	KNORR SB-SN7 AXIAL (0°)	AV/F	EFR7303	EFR7302	2920200764
	KNORR SB-SN7 AXIAL (-12°)	AR/R	EFR7301	EFR7300	2927802 292530539

VOLVO TRUCKS (CARS ET BUS)

7700; 8500 (4x2 & 6x2) 01.99-05.06

22,5"	MERITOR D LISA	AV/F	EFR7612	EFR7613	2909009 CVP023K
-------	----------------	------	----------------	----------------	----------------------------------

7700 (4x2 & 6x2) 06.06

22,5"	MERITOR ELSA 225-3	AV/F	EFR76XX	EFR76XX	2917400604 2917401
		AR/R	EFR76XX	EFR76XX	2927301

8500; 8700 (4x2 & 6x2 & 6x2/4) 01.99-

22,5"	MERITOR ELSA 225-3	AV/F	EFR76XX	EFR76XX	2917400604 2917401
		AR/R	EFR76XX	EFR76XX	2927301

9700; 9900 (4x2 & 6x2 & 6x2/4) 01.01-09.07

22,5"	MERITOR D DUCO AXIAL	AV/F	EFR7622	EFR7623	2927705 CVP037K
-------	-------------------------	------	----------------	----------------	----------------------------------

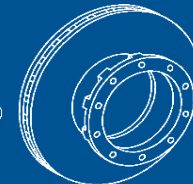
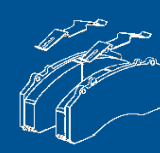
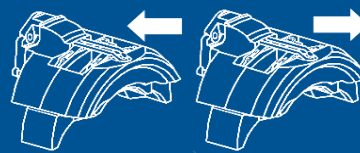
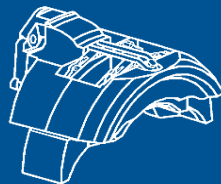
9700; 9900 (4x2 & 6x2 & 6x2/4) 10.07-

22,5"	MERITOR ELSA 225-3	AV/F	EFR76XX	EFR76XX	2917400604 2917401
		AR/R	EFR76XX	EFR76XX	2927301

B7L; B10B; B10BLE; B10L; B10LE; OLYMPIA 01.87-

22,5"	MERITOR D LISA	AV/F	EFR7612	EFR7613	2909009 CVP023K	09.9396.10 FCR192A 93105500
22,5"	MERITOR D LISA	AR/R				

APPLICATION PAR VEHICULES
APPLICATION BY VEHICLES

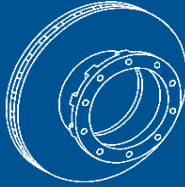
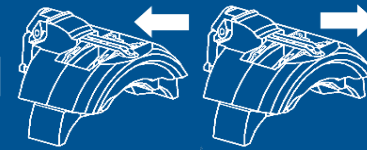
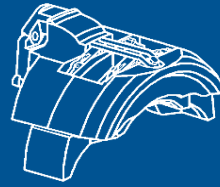


VOLVO TRUCKS (CARS ET BUS) ..!

B9SA LE 01.95-	22,5" MERITOR D LISA	AV/F	EFR7612	EFR7613	2909009 CVP023K	09.9396.10 FCR192A 93105500
B9TL 01.00-	22,5" MERITOR ELSA 2	AV/F AR/R	EFR7706	EFR7707	2913105 CVP088K	
B12 02.06-	22,5" MERITOR D DUCO AXIAL	AR/R	EFR7622	EFR7623	2927705 CVP037K	09.E161.10 FCR353A
B12B LE 01.99-	22,5" MERITOR D LISA	AV/F	EFR7612	EFR7613	2909009 CVP023K	
B12M 01.05-	MERITOR ELSA 225-3 RADIAL	AV/F	EFR7676 EFR7676R	EFR7677 EFR7677R	2917400604 2917401	09.E161.10 FCR353A
	MERITOR ELSA 225-3 AXIAL	AV/F	EFR7688 EFR7688R	EFR7689 EFR7689R	2927301	
CITYBUS 5010 01.00-	22,5" MERITOR ELSA 2	AV/F AR/R	EFR7706	EFR7707	2913105 CVP088K	
ECLIPSE 01.03-	MERITOR ELSA 225-3 RADIAL	AV/F	EFR7676 EFR7676R	EFR7677 EFR7677R	2917400604 2917401	
	MERITOR ELSA 225-3 AXIAL	AV/F	EFR7688 EFR7688R	EFR7689 EFR7689R	2927301	

Automotive

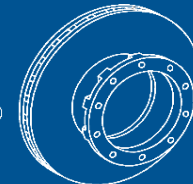
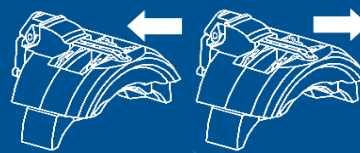
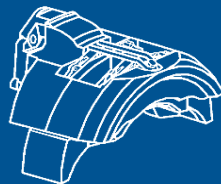
APPLICATION PAR VEHICULES
APPLICATION BY VEHICLES



VOLVO TRUCKS (TRUCKS)

FL SERIE (FL180-18; FL220-18; FL250-18) (4x2) 03.00-	22,5"	MERITOR D DUCO RADIAL	AV/F	EFR7624	EFR7625	2927705	
		MERITOR D DUCO AXIAL	AR/R	EFR7630	EFR7631	CVP037K	
FLSERIE (FL180-7,5; FL180-8; FL180-9; FL180-10; FL180-11; FL180-12; FL220-7,5; FL220-8; FL220-9; FL220-10; FL220-11; FL220-12; FL250-7,5; FL250-8; FL250-9; FL250-10; FL250-11; FL250-12) (4x2) 03.00-	17,5"	MERITOR B DUCO	AV/F	EFR7618	EFR7619	2913606	08.8240.10
			AR/R				FCR303A 93308600
FL SERIE EUROPA (FL180-13; FL180-14; FL180-15; FL180-16; FL180-17; FL220-13; FL220-14; FL220-15; FL220-16; FL220-17; FL250-13; FL250-14; FL250-15; FL250-16; FL250-17) (4x2) 03.00-	19,5"	MERITOR C DUCO	AV/F	EFR6620	EFR6621	2913706	DF713813
			AR/R				FCR278A 93243000
FL II (FL240-12; FL240-14; FL240-15; FL240-16; FL240-18; FL260-12; FL260-14; FL260-15; FL260-16; FL260-18; FL280-12; FL280-14; FL280-15; FL280-16; FL280-18; FL290-12; FL290-14; FL290-16; FL290-18; FL300-12; FL300-13; FL300-14; FL300-15; FL300-16; FL300-18; FL340-12; FL340-13; FL340-14; FL340-15; FL340-16; FL340-18) (4x2) 05.06-	19,5"	HALDEX DB 19	AV/F			W0365RT2	DF60002 09.9494.40
		HALDEX DB 19 pour/for 4x4	AR/R	EFR6200	EFR6200	29181006042 918101	FCR324A 93222700
FL II (FL240-12; FL240-14; FL240-15; FL240-16; FL240-18; FL260-12; FL260-14; FL260-15; FL260-16; FL260-18; FL280-12; FL280-14; FL280-15; FL280-16; FL280-18; FL290-12; FL290-14; FL290-16; FL290-18; FL300-12; FL300-13; FL300-14; FL300-15; FL300-16; FL300-18; FL340-12; FL340-13; FL340-14; FL340-15; FL340-16; FL340-18) (4x2) 05.06-	19,5"	WABCO MAXX 19	AV/F	EFR6012	EFR6013	2928401	W0335RT1 98065500
			AR/R	EFR6014	EFR6015	CVP116K	DF60002 09.9494.40 FCR324A 93222700

APPLICATION PAR VEHICULES APPLICATION BY VEHICLES



VOLVO TRUCKS (TRUCKS)/.

FL III (FL210-10; FL210-12; FL210-14; FL210-16;
FL240-10; FL240-12; FL240-14; FL240-15; FL240-16;
FL240-18; FL250-12; FL250-14; FL250-16; FL250-18;
FL260-12; FL260-14; FL260-15; FL260-16; FL260-18;
FL280-12; FL280-14; FL280-16; FL280-18; FL290-12;
FL290-14; FL290-16; FL290-18) (4x2 & 4x4) 05.13-

WABCO MAXX 19

AV/F

EFR6012

EFR6013

DF60002

09.9494.40

WABCO MAXX 19

19,5" (Pour/For 4x2)

2928401
CVP116K

W0335RT1
98065500

FCR324A

93222700

WABCO MAXX 19

(Pour/For 4x4)

AR/R

EFR6014

EFR6015

09.9496.10

FCR378A

93192500

FL II (FL240-12; FL240-14; FL240-15; FL240-16; FL240-
18; FL260-12; FL260-14; FL260-15; FL260-16; FL260-
18; FL280-12; FL280-14; FL280-15; FL280-16; FL280-
18; FL290-12; FL290-14; FL290-16; FL290-18; FL300-
12; FL300-13; FL300-14; FL300-15; FL300-16; FL300-
18; FL340-12; FL340-13; FL340-14; FL340-15; FL340-
16; FL340-18) (4x2) 05.06-

22,5" MERITOR ELSA 225-1
AXIAL

AV/F

EFR7680
EFR7680R

EFR7681
EFR7681R

2917300604
2917301
2927201

DF70010

FCR259A

93272000

ou/or

DF70005

FCR249A

93272100

AR/R

EFR7690
EFR7690R

EFR7691
EFR7691R

FL III (FL210-10; FL210-12; FL210-14; FL210-16;
FL240-10; FL240-12; FL240-14; FL240-15; FL240-16;
FL240-18; FL250-12; FL250-14; FL250-16; FL250-18;
FL260-12; FL260-14; FL260-15; FL260-16; FL260-18;
FL280-12; FL280-14; FL280-16; FL280-18; FL290-12;
FL290-14; FL290-16; FL290-18) (4x2 & 4x4) 05.13-

22,5" MERITOR ELSA 225-1
AXIAL

AV/F

EFR7680
EFR7680R

EFR7681
EFR7681R

2917300604
2917301
2927201

DF70010

FCR259A

93272000

ou/or

DF70005

FCR249A

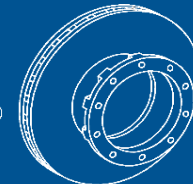
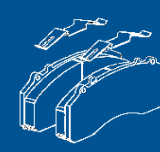
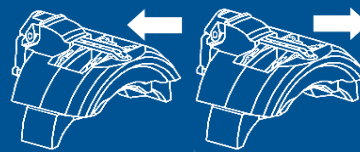
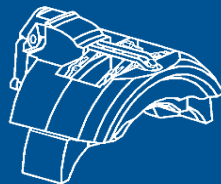
93272100

AR/R

EFR7690
EFR7690R

EFR7691
EFR7691R

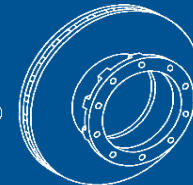
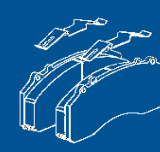
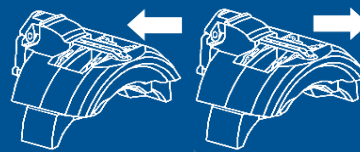
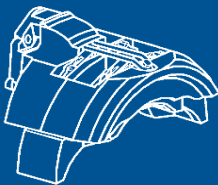
APPLICATION PAR VEHICULES APPLICATION BY VEHICLES



VOLVO TRUCKS (TRUCKS)/

	MERITOR ELSA 225-3 RADIAL	AV/F	EFR7676 EFR7676R	EFR7677 EFR7677R	2917400604 2917401 2927301	DF70010 FCR259A 93272000 ou/or DF70005 FCR249A 93272100
	MERITOR ELSA 225-3 AXIAL	AV/F	EFR7688 EFR7688R	EFR7689 EFR7689R		
FH12 SERIE (FH12/340; FH12/380; FH12/390; FH12/420; FH12/460; FH12/500) (4x2 & 6x2 & 6x2/4 & 6x4 & 8x2/4 & 8x4/4 & 8x2/6) 08.93-09.05	MERITOR VGT 195 (Essieu relevable/Lifting Axle)	AR/R2	EFR6600	EFR6601	2917705 CVP095K	DF70011 09.E451.10 FCR328A 93322800
	MERITOR ELSA 225-1 AXIAL	AR/R	EFR7690 EFR7690R	EFR7691 EFR7691R	2917300604 2917301 2927201	DF70010 FCR259A 93272000 ou/or DF70009 FCR348A 93322700
	MERITOR ELSA 225-3 RADIAL	AR/R	EFR7676 EFR7676R	EFR7677 EFR7677R	2917400604 2917401 2927301	
	MERITOR ELSA 225-3 AXIAL	AR/R	EFR7688 EFR7688R	EFR7689 EFR7689R		
FH12 SERIE (FH12/500) (4x2 & 6x2) (Pour Air Suspension ar / For Air suspension rear) 07.01-	MERITOR D DUCO RADIAL	AV/F	EFR7624	EFR7625	2927705	
	MERITOR D DUCO AXIAL	AV/F AR/R	EFR7630 EFR7622	EFR7631 EFR7623	CVP037K	

APPLICATION PAR VEHICULES APPLICATION BY VEHICLES



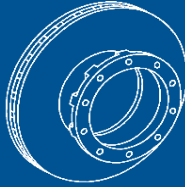
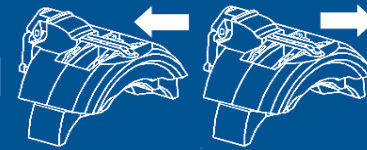
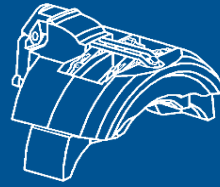
VOLVO TRUCKS (TRUCKS) ..!

FH16 SERIE (FH16/470; FH16/520; FH16/540; FH16/550; FH16/580; FH16/600; FH16/610; FH16/660; FH16/700) (4x2 & 6x2 & 6x2/4 & 6x4 & 8x2 & 8x2/4 & 8x2/6 & 8x4 & 8x4/4) 08.93-

22,5"	MERITOR ELSA 225-3 RADIAL	AV/F	EFR7676 EFR7676R	EFR7677 EFR7677R	2917400604 2917401 2927301	DF70010 FCR259A 93272000 ou/or DF70005 FCR249A 93272100
	MERITOR ELSA 225-3 AXIAL		EFR7688 EFR7688R	EFR7689 EFR7689R		
19,5"	MERITOR VGT 195 (Essieu relevable/Lifting Axle)	AR/R2	EFR6600	EFR6601	2917705 CVP095K	DF70011 09.E451.10 FCR328A 93322800
	MERITOR ELSA 225-1 AXIAL		EFR7690 EFR7690R	EFR7691 EFR7691R	2917300604 2917301 2927201	DF70010 FCR259A 93272000
22,5"	MERITOR ELSA 225-3 RADIAL	AR/R	EFR7676 EFR7676R	EFR7677 EFR7677R	2917400604 2917401 2927301	ou/or DF70009 FCR348A 93322700
	MERITOR ELSA 225-3 AXIAL		EFR7688 EFR7688R	EFR7689 EFR7689R		

Automotive

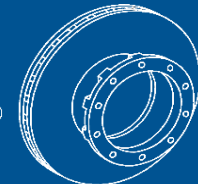
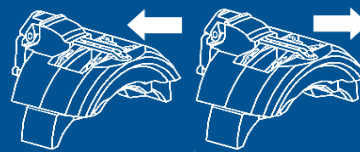
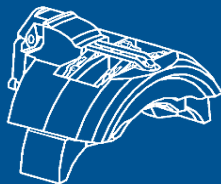
APPLICATION PAR VEHICULES
APPLICATION BY VEHICLES



VOLVO TRUCKS (TRUCKS)/

	MERITOR ELSA 225-3 RADIAL		EFR7676 EFR7676R	EFR7677 EFR7677R	2917400604 2917401 2927301	DF70010 FCR259A 93272000 ou/or DF70005 FCR249A
	22,5" MERITOR ELSA 225-3 AXIAL	AV/F	EFR7688 EFR7688R	EFR7689 EFR7689R		
	MERITOR LE DUCO (Essieu relevable/Lift axle)		EFR7628	EFR7629	2915102	
FH16 SERIE (FH16/580; FH16/660) (4x2 & 6x2 & 6x2/4 & 6x4 & 8x2 & 8x2/4 & 8x2/6 & 8x4) 09.06-	MERITOR VGT 195 (Essieu relevable/Lifting Axle)	AR/R2	EFR6600	EFR6601	2917705 CVP095K	DF70011 09.E451.10 FCR328A 93322800
	19,5" MERITOR ELSA 225-1 AXIAL		EFR7690 EFR7690R	EFR7691 EFR7691R	2917300604 2917301 2927201	DF70010 FCR259A 93272000 ou/or DF70009 FCR348A 93322700
	22,5" MERITOR ELSA 225-3 RADIAL	AR/R	EFR7676 EFR7676R	EFR7677 EFR7677R	2917400604 2917401 2927301	
	MERITOR ELSA 225-3 AXIAL		EFR7688 EFR7688R	EFR7689 EFR7689R		
	22,5" MERITOR D DUCO RADIAL	AV/F	EFR7624	EFR7625	2927705 CVP037K	
FH16 SERIE (FH16/540; FH16/550; FH16/610) (4x2 & 6x2 & 6x2/4 & 6x4 & 8x2 & 8x4) (Pour Air Suspension ar / For Air suspension rear) 07.01-	MERITOR D DUCO AXIAL	AR/R	EFR7630 EFR7622	EFR7631 EFR7623		

APPLICATION PAR VEHICULES
APPLICATION BY VEHICLES

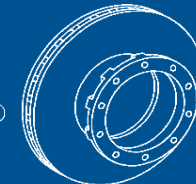
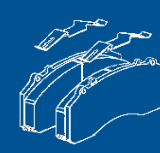
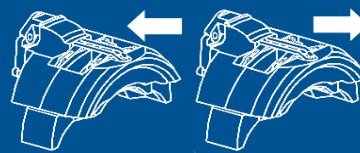
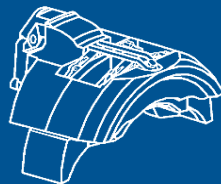


VOLVO TRUCKS (TRUCKS)/.

	MERITOR ELSA 225-3 RADIAL	AV/F	EFR7676 EFR7676R	EFR7677 EFR7677R	2917400604 2917401 2927301	09.A779.20
					TM	DF70010 FCR259A 93272000 ou/or DF70009 FCR348A 93322700
FE SERIE (FE240-18; FE240-22; FE240-26; FE260-18; FE260-26; FE280-18; FE280-22; FE280-26; FE300-18; FE300-18HYBRID; FE300-26; FE300-26HYBRID; FE320-18; FE320-22; FE320-26; FE340-18; FE340-18HYBRID; FE340-26; FE340-26HYBRID) (4x2 & 6x2 & 6x2/4 & 6x4) 05.06-04.12	MERITOR ELSA 225-1 AXIAL	AR/R2	EFR7690 EFR7690R	EFR7691 EFR7691R	2917300604 2917301 2927201	DF70010 FCR259A 93272000 ou/or DF70005 FCR249A 93272100
		22,5"				
	MERITOR ELSA 225-3 AXIAL	AR/R	EFR7688 EFR7688R	EFR7689 EFR7689R	2917400604 2917401 2927301	DF70010 FCR259A 93272000 ou/or DF70005 FCR249A 93272100

Automotive

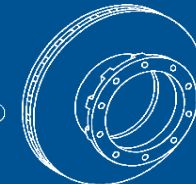
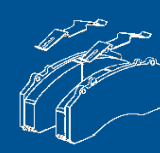
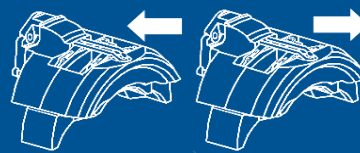
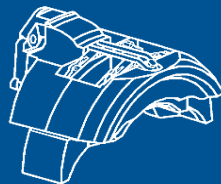
APPLICATION PAR VEHICULES APPLICATION BY VEHICLES



VOLVO TRUCKS (TRUCKS)/.

		MERITOR ELSA 225-3 RADIAL	AV/F	EFR7676 EFR7676R	EFR7677 EFR7677R	2917400604 2917401 2927301	09.A779.20
						TM	DF70010 FCR259A 93272000
FE II SERIE (FE240-18; FE240-26; FE250-18; FE250-26; FE260-18; FE260-26; FE280-18; FE280-26; FE300-18; FE300-26; FE320-18; FE320-18CNG; FE320-26; FE320-26CNG; FE340-18; FE340-26) (4x2 & 6x2 & 6x2/4 & 6x4) 05.12-	22,5"	MERITOR ELSA 225-1 AXIAL	AR/R2	EFR7690 EFR7690R	EFR7691 EFR7691R	2917300604 2917301 2927201	ou/or DF70009 FCR348A 93322700
		MERITOR ELSA 225-3 AXIAL	AR/R	EFR7688 EFR7688R	EFR7689 EFR7689R	2917400604 2917401 2927301	DF70010 FCR259A 93272000 ou/or DF70005 FCR249A 93272100
		MERITOR D DUCO RADIAL	AV/F	EFR7624	EFR7625		
FM7 SERIE (FM7/250; FM7/290) (4x2 & 6x2 & 6x4) 05.01-	22,5"	MERITOR D DUCO AXIAL		EFR7630	EFR7631	2927705	
		MERITOR D DUCO AXIAL (Suspension Mécanique/Mechanical Suspension)	AR/R	EFR7622	EFR7623	CVP037K	

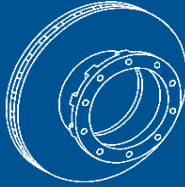
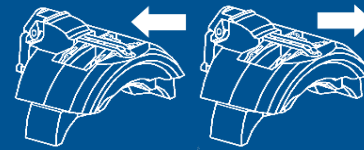
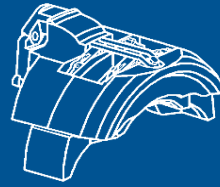
APPLICATION PAR VEHICULES APPLICATION BY VEHICLES



VOLVO TRUCKS (TRUCKS)/

FM9 (FM9/260; FM9/300; FM9/340; FM9/380) (4x2 & 6x2 & 6x4 & 8x4/4) 05.01-09.05	MERITOR D DUCO RADIAL	AV/F	EFR7624	EFR7625	2927705	DF70010 FCR259A 93272000
	MERITOR D DUCO AXIAL (FAA20)		EFR7622	EFR7623	CVP037K	
	MERITOR LE DUCO (Essieu relevable/Lift axle)	AR/R2	EFR7628	EFR7629	2915102	
	19,5" MERITOR C DUCO		EFR6620	EFR6621	2913706	
FM9 SERIE (FM9/260; FM9/300; FM9/340; FM9/380) (4x2 & 6x2 & 6x4 & 8x4/4) (Pour Air Suspension ar / For Air suspension rear) 12.01-09.05	MERITOR D DUCO AXIAL (FAA10)	AR/R	EFR7630	EFR7631	2927705	DF70010 FCR259A 93272000
	MERITOR D DUCO AXIAL (FAA20)		EFR7622	EFR7623	CVP037K	
	MERITOR D DUCO RADIAL	AV/F	EFR7624	EFR7625	2927705	
FM10 SERIE (FM10/320; FM10/360) (4x2 & 6x2) 05.01-	MERITOR D DUCO AXIAL	AR/R	EFR7622	EFR7623	CVP037K	DF70010 FCR259A 93272000
	MERITOR D DUCO RADIAL	AV/F	EFR7624	EFR7625	2927705	
FM12 (FM12/340; FM12/380; FM12/420; FM12/460) (4x2 & 6x2 & 6x4 & 8x2/4 & 8x4/4) 09.01-09.05	MERITOR D DUCO RADIAL	AV/F	EFR7624	EFR7625	2927705	DF70010 FCR259A 93272000
	MERITOR LE DUCO (Essieu relevable/Lift axle)	AR/R2	EFR7628	EFR7629	2915102	
	MERITOR D DUCO AXIAL	AR/R	EFR7622	EFR7623	2927705	
					CVP037K	

**APPLICATION PAR VEHICULES
APPLICATION BY VEHICLES**



VOLVO TRUCKS (TRUCKS) ..!..

FM12 SERIE (FM12/340; FM12/380; FM12/420; FM12/460) (4x2 & 6x2 & 6x4 & 8x2/4 & 8x4/4) (Pour Air Suspension ar / For Air suspension rear) 09.01-09.05

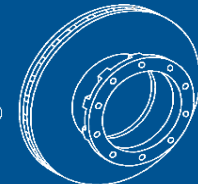
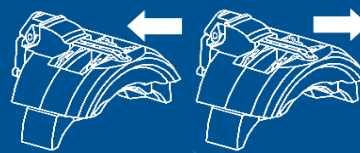
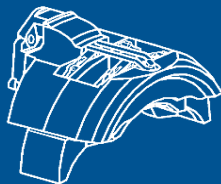
22,5"	MERITOR D DUCO RADIAL	AV/F	EFR7624	EFR7625	2927705 CVP037K	DF70010 FCR259A 93272000
	MERITOR D DUCO AXIAL	AR/R	EFR7630	EFR7631		
			EFR7622	EFR7623	TM	

22,5"	MERITOR ELSA 225-3 RADIAL	AV/F	EFR7676	EFR7677	2917400604 2917401 2927301	DF70010 FCR259A 93272000 ou/or DF70005 FCR249A 93272100
			EFR7676R	EFR7677R		
22,5"	MERITOR ELSA 225-3 AXIAL		EFR7688	EFR7689		
			EFR7688R	EFR7689R		

FM SERIE (FM300; FM330; FM340; FM360; FM370; FM380; FM390; FM400; FM410; FM420; FM430; FM440; FM450; FM460; FM480; FM500) (4x2 & 4x4 & 6x2 & 6x2/4 & 6x4 & 6x6 & 8x2/4 & 8x2/6 & 8x4 & 8x4/4 & 10x4/4) 09.05-12.11

19,5"	MERITOR ELSA 195 AXIAL (Essieu relevable/Lifting axle)	AR/R2	EFR6656	EFR6657	2917705 CVP095K	DF70011 09.E451.10 FCR328A 93322800
22,5"	MERITOR ELSA 225-1 AXIAL	AR/R2	EFR7690	EFR7691	2917300604 2917301 2927201	DF70010 FCR259A 93272000 ou/or DF70009 FCR348A 93322700
			EFR7690R	EFR7691R		
22,5"	MERITOR ELSA 225-3 RADIAL	AR/R	EFR7676	EFR7677	2917400604 2917401 2927301	
			EFR7676R	EFR7677R		
22,5"	MERITOR ELSA 225-3 AXIAL	AR/R	EFR7688	EFR7689		
			EFR7688R	EFR7689R		

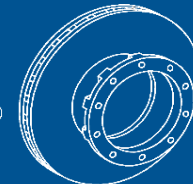
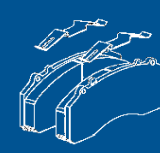
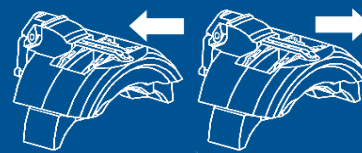
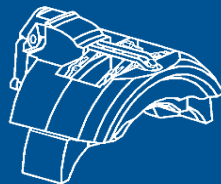
APPLICATION PAR VEHICULES APPLICATION BY VEHICLES



VOLVO TRUCKS (TRUCKS)/

FM II SERIE (FM420; FM420LNG; FM460; FM460LNG; FM500) (4x2 & 6x2 & 6x4 & 10x4/6) 01.12-	22,5"	MERITOR ELSA 225-3 RADIAL	AV/F	EFR7676 EFR7676R	EFR7677 EFR7677R	2917400604 2917401 2927301	DF70010 FCR259A 93272000 ou/or DF70005
	22,5"	MERITOR ELSA 225-3 AXIAL		EFR7688 EFR7688R	EFR7689 EFR7689R	2917401 2927301	FCR249A 93272100 DF70011
	19,5"	MERITOR ELSA 195 AXIAL (Essieu relevable/Lifting axle)	AR/R2	EFR6656	EFR6657	2917705 CVP095K	09.E451.10 FCR328A 93322800
	22,5"	MERITOR ELSA 225-1 AXIAL	AR/R2	EFR7690 EFR7690R	EFR7691 EFR7691R	2917300604 2917301 2927201	DF70010 FCR259A 93272000
	22,5"	MERITOR ELSA 225-3 RADIAL	AR/R	EFR7676 EFR7676R	EFR7677 EFR7677R	2917400604 2917401	ou/or DF70009 FCR348A
	22,5"	MERITOR ELSA 225-3 AXIAL	AR/R	EFR7688 EFR7688R	EFR7689 EFR7689R	2927301	93322700
FMX SERIE (330; 370; 380; 400; 410; 420; 430; 440; 450; 460; 480; 500; 540) (4x2 & 4x4 & 6x2 & 6x2/4 & 6x4 & 6x6 & 8x2 & 8x2/4 & 8x2/6 & 8x4 & 8x4/4 & 8x6/4) 04.10-	22,5"	MERITOR ELSA 225-3 RADIAL	AV/F	EFR7676 EFR7676R	EFR7677 EFR7677R	2917400604 2917401 2927301	DF70010 FCR259A 93272000 DF70011
	19,5"	MERITOR ELSA 195 AXIAL (Essieu relevable/Lifting axle)	AR/R2	EFR6656	EFR6657	2917705 CVP095K	09.E451.10 FCR328A 93322800
	22,5"	MERITOR ELSA 225-1 AXIAL	AR/R2	EFR7690 EFR7690R	EFR7691 EFR7691R	2917300604 2917301 2927201	DF70010 FCR259A 93272000
	22,5"	MERITOR ELSA 225-3 AXIAL	AR/R	EFR7688 EFR7688R	EFR7689 EFR7689R	2917400604 2917401 2927301	ou/or DF70009 FCR348A 93322700

APPLICATION PAR VEHICULES
APPLICATION BY VEHICLES



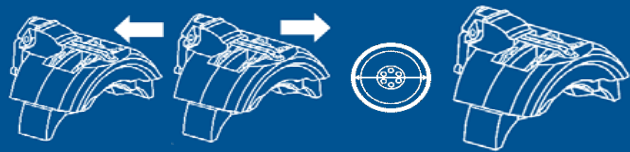
VOLVO TRUCKS (TRUCKS)/.

FMX II SERIE (330; 370; 380; 410; 420; 450; 460; 500; 540) (4x2 & 4x4 & 6x2 & 6x2/4 & 6x4 & 6x6 & 8x2 & 8x2/4 & 8x2/6 & 8x4 & 8x4/4 & 8x6/4 & 10x4/6 & 10x6/6) 04.12-

22,5"	MERITOR ELSA 225-3 RADIAL	AV/F	EFR7676 EFR7676R	EFR7677 EFR7677R	2917400604 2917401 2927301	DF70010 FCR259A 93272000
19,5"	MERITOR ELSA 195 AXIAL (Essieu relevalable/Lifting axle)	AR/R2	EFR6656	EFR6657	2917705 CVP095K	DF70011 09.E451.10 FCR328A 93322800
22,5"	MERITOR ELSA 225-1 AXIAL	AR/R2	EFR7690 EFR7690R	EFR7691 EFR7691R	2917300604 2917301 2927201	DF70010 FCR259A 93272000 ou/or DF70009 FCR348A 93322700
22,5"	MERITOR ELSA 225-3 AXIAL	AR/R	EFR7688 EFR7688R	EFR7689 EFR7689R	2917400604 2917401 2927301	DF70010 FCR259A 93272000 ou/or DF70009 FCR348A 93322700

Automotive

PIECES DETACHEES ETRIER DE FREIN CALIPER SPARE PARTS


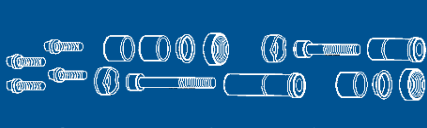



Autre /
other

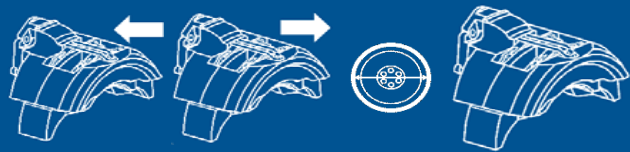
Designation

Part Number	Part Number	Size	Model	Pin 1	Pin 2	Pin 3 versions	Shim 1	Shim 2	Other / other	Designation
EFR5000	EFR5001	17,5"	WABCO PAN 17	CAC017					CAC020	Plaque compression G/Push plate Left
									CAC021	Plaque compression D/Push plate right
EFR5002	EFR5003	17,5"	WABCO PAN 17	CAC017					CAC020	Plaque compression G/Push plate Left
									CAC021	Plaque compression D/Push plate right
EFR5004	EFR5005	19,5"	WABCO 1600 V-G							
EFR5006	EFR5007	17,5"	WABCO PAN 17	CAC017					CAC020	Plaque compression G/Push plate Left
									CAC021	Plaque compression D/Push plate right
EFR5008	EFR5009	17,5"	WABCO 1000 V-G							
EFR5010	EFR5011	17,5"	WABCO MAXX 17							
EFR5012	EFR5013	17,5"	WABCO MAXX 17							
EFR5300	EFR5301	17,5"	KNORR SB-SN5	CAC005			CAC008			
EFR5302	EFR5303	17,5"	KNORR SB-SN5	CAC005			CAC008			
EFR5304	EFR5305	17,5"	KNORR SB-SN5							
EFR6002	EFR6003	19,5"	WABCO PAN 19-2	CAC018						
EFR6004	EFR6005	19,5"	WABCO PAN 19-1 Plus	CAC019						
EFR6006	EFR6007	19,5"	WABCO PAN 19-1 Plus	CAC019					CAC022	Plaque compression G/Push plate Left
									CAC023	Plaque compression D/Push plate right
EFR6010	EFR6011	19,5"	WABCO PAN 19-1 Plus						CAC022	Plaque compression G/Push plate Left
									CAC023	Plaque compression D/Push plate right
EFR6012	EFR6013	19,5"	WABCO MAXX 19							
EFR6014	EFR6015	19,5"	WABCO MAXX 19							
EFR6124	EFR6125	19,5"	WABCO 1300 V-G							
EFR6200	EFR6200	19,5"	HALDEX DB 19							
EFR6201	EFR6201	19,5"	HALDEX DB 19							
EFR6202	EFR6203	19,5"	HALDEX DBT 19LT							
EFR6300	EFR6301	19,5"	KNORR SB-SN6 AXIAL	CAC005	CAC025	CAC042	CAC008	CAC009	CAC004	Kit écrous de réglage/Adj. Nut
									CAC006	Régleur complet/Adj. Mechanism
EFR6302	EFR6303	19,5"	KNORR SB-SN6 AXIAL	CAC005	CAC042		CAC008		CAC004	Kit écrous de réglage/Adj. Nut
									CAC006	Régleur complet/Adj. Mechanism

PIECES DETACHEES ETRIER DE FREIN CALIPER SPARE PARTS

											Autre / other	Designation
				1	2	3 versions	1	2				
EFR6304	EFR6305	19,5"	KNORR SB-SN6 AXIAL	CAC025	CAC042		CAC008	CAC009	CAC004	Kit écrous de réglage/Adj. Nut		
									CAC006	Régleur complet/Adj. Mechanism		
EFR6306	EFR6307	19,5"	KNORR SB-SN6 AXIAL	CAC025			CAC008	CAC009	CAC004	Kit écrous de réglage/Adj. Nut		
									CAC006	Régleur complet/Adj. Mechanism		
EFR6308	EFR6309	22,5"	KNORR SK7	CAC026	CAC042		CAC009		CAC004	Kit écrous de réglage/Adj. Nut		
									CAC006	Régleur complet/Adj. Mechanism		
EFR6310	EFR6311	19,5"	KNORR SB-SN6 AXIAL	CAC005	CAC042		CAC008		CAC004	Kit écrous de réglage/Adj. Nut		
									CAC006	Régleur complet/Adj. Mechanism		
EFR6312	EFR6313	19,5"	KNORR SB-SN6 AXIAL	CAC042			CAC009		CAC004	Kit écrous de réglage/Adj. Nut		
									CAC006	Régleur complet/Adj. Mechanism		
EFR6314	EFR6315	19,5"	KNORR SB-SN6 AXIAL	CAC042			CAC009		CAC004	Kit écrous de réglage/Adj. Nut		
									CAC006	Régleur complet/Adj. Mechanism		
EFR6317	EFR6316	19,5"	KNORR SB-SN6 AXIAL	CAC042			CAC009		CAC004	Kit écrous de réglage/Adj. Nut		
									CAC006	Régleur complet/Adj. Mechanism		
EFR6600	EFR6601	19,5"	MERITOR VGT 195	CAC028					CAC001	Cache anti-poussière/Cap Gasket		
EFR6602	EFR6603	19,5"	MERITOR ELSA 195 LE	CAC015			CAC011		CAC001	Cache anti-poussière/Cap Gasket		
EFR6620	EFR6621	19,5"	MERITOR C DUCO	CAC013			CAC011		CAC001	Cache anti-poussière/Cap Gasket		
EFR6626	EFR6627	19,5"	MERITOR C DUCO	CAC013			CAC011		CAC001	Cache anti-poussière/Cap Gasket		
EFR6650	EFR6651	19,5"	MERITOR DX 195	CAC016								
EFR6654	EFR6655	19,5"	MERITOR C LISA									
EFR6656	EFR6657	19,5"	MERITOR ELSA 195 AXIAL	CAC028					CAC001	Cache anti-poussière/Cap Gasket		
EFR6900	EFR6901	19,5"	BENDIX ADB 3700									
EFR6902	EFR6903	19,5"	BENDIX ADB 3700									
EFR6950	EFR6951	19,5"	BPW TSB3709 ECO DISC									
EFR6952	EFR6953	19,5"	BPW TS2 3709 ECO DISC									
EFR7000	EFR7001	22,5"	WABCO PAN 22-2	CAC018	CAC019							
EFR7002	EFR7003	22,5"	WABCO PAN 22-1	CAC019								
EFR7004	EFR7005	22,5"	WABCO MAXX 22									
EFR7006	EFR7007	22,5"	WABCO MAXX 22									

PIECES DETACHEES ETRIER DE FREIN CALIPER SPARE PARTS



Autre /
other

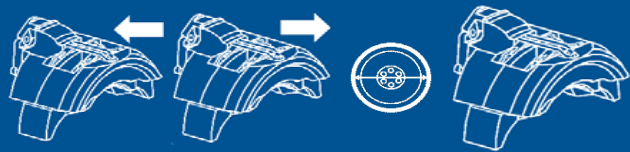
Designation

Part 1	Part 2	Size	Model	Pin 1	Pin 2	Pin 3 versions	Shim 1	Shim 2	Other / other	Designation
EFR7010	EFR7011	22,5"	WABCO MAXX 22L							
EFR7200	EFR7200	22,5"	HALDEX DB 22							
EFR7201	EFR7201	22,5"	HALDEX DB 22							
EFR7202	EFR7202	22,5"	HALDEX MODULX DB 22							
EFR7203	EFR7203	22,5"	HALDEX MODULX DB 22							
EFR7204	EFR7204	22,5"	HALDEX DB 22 LT							
EFR7206	EFR7207	22,5"	HALDEX DBT 22LT							
EFR7208	EFR7208	22,5"	HALDEX DB 22							
EFR7209	EFR7209	22,5"	HALDEX DB 22							
EFR7210	EFR7211	22,5"	HALDEX DBT 22LT							
EFR7300	EFR7301	22,5"	KNORR SB-SN7 AXIAL	CAC005	CAC042		CAC008	CAC009	CAC004 CAC006	Kit écrous de réglage/Adj. Nut Régleur complet/Adj. Mechanism
EFR7302	EFR7303	22,5"	KNORR SB-SN7 AXIAL	CAC005	CAC025	CAC042	CAC008	CAC009	CAC004 CAC006	Kit écrous de réglage/Adj. Nut Régleur complet/Adj. Mechanism
EFR7304	EFR7305	22,5"	KNORR SB-SN7 AXIAL	CAC005	CAC025	CAC042	CAC008	CAC009	CAC004 CAC006	Kit écrous de réglage/Adj. Nut Régleur complet/Adj. Mechanism
EFR7306	EFR7307	22,5"	KNORR SB7 RADIAL	CAC005	CAC042		CAC008		CAC004 CAC006	Kit écrous de réglage/Adj. Nut Régleur complet/Adj. Mechanism
EFR7308	EFR7309	22,5"	KNORR SB-SN7 AXIAL	CAC005	CAC025	CAC042	CAC008	CAC009	CAC004 CAC006	Kit écrous de réglage/Adj. Nut Régleur complet/Adj. Mechanism
EFR7310	EFR7311	22,5"	KNORR SB-SN7 AXIAL	CAC005	CAC025	CAC042	CAC008	CAC009	CAC004 CAC006	Kit écrous de réglage/Adj. Nut Régleur complet/Adj. Mechanism
EFR7312	EFR7313	22,5"	KNORR SB-SN7 AXIAL	CAC005	CAC042		CAC008		CAC004 CAC006	Kit écrous de réglage/Adj. Nut Régleur complet/Adj. Mechanism
EFR7314	EFR7315	22,5"	KNORR SB7 RADIAL	CAC005	CAC042		CAC008		CAC004 CAC006	Kit écrous de réglage/Adj. Nut Régleur complet/Adj. Mechanism
EFR7316	EFR7317	22,5"	KNORR SB7 RADIAL	CAC005	CAC042		CAC008		CAC004 CAC006	Kit écrous de réglage/Adj. Nut Régleur complet/Adj. Mechanism

PIECES DETACHEES ETRIER DE FREIN CALIPER SPARE PARTS

									Autre / other	Designation
				1	2	3 versions	1	2		
EFR7320	EFR7321	22,5"	KNORR SB-SN7 AXIAL	CAC026	CAC042		CAC009		CAC004	Kit écrous de réglage/Adj. Nut
									CAC006	Régleur complet/Adj. Mechanism
EFR7322	EFR7323	22,5"	KNORR SB7 RADIAL	CAC042			CAC008		CAC004	Kit écrous de réglage/Adj. Nut
									CAC006	Régleur complet/Adj. Mechanism
EFR7324	EFR7325	22,5"	KNORR SB-SN7 RADIAL	CAC005	CAC042		CAC008		CAC004	Kit écrous de réglage/Adj. Nut
									CAC006	Régleur complet/Adj. Mechanism
EFR7326	EFR7327	22,5"	KNORR SB-SN7 AXIAL	CAC042			CAC008	CAC009	CAC004	Kit écrous de réglage/Adj. Nut
									CAC006	Régleur complet/Adj. Mechanism
EFR7328	EFR7329	22,5"	KNORR SB-SN7 AXIAL	CAC042			CAC009		CAC004	Kit écrous de réglage/Adj. Nut
									CAC006	Régleur complet/Adj. Mechanism
EFR7332	EFR7333	22,5"	KNORR SB-SN7 AXIAL	CAC042			CAC009		CAC004	Kit écrous de réglage/Adj. Nut
									CAC006	Régleur complet/Adj. Mechanism
EFR7334	EFR7335	22,5"	KNORR SB-SN7 AXIAL	CAC042			CAC008		CAC004	Kit écrous de réglage/Adj. Nut
									CAC006	Régleur complet/Adj. Mechanism
EFR7336	EFR7337	22,5"	KNORR SB-SN7 AXIAL	CAC025	CAC042		CAC009		CAC004	Kit écrous de réglage/Adj. Nut
									CAC006	Régleur complet/Adj. Mechanism
EFR7340	EFR7341	22,5"	KNORR SB7 RADIAL	CAC042			CAC008		CAC004	Kit écrous de réglage/Adj. Nut
									CAC006	Régleur complet/Adj. Mechanism
EFR7344	EFR7345	22,5"	KNORR SB-SN7 AXIAL	CAC042			CAC009			
EFR7346	EFR7347	22,5"	KNORR SL7 AXIAL	CAC025			CAC043			
EFR7348	EFR7349	22,5"	KNORR SM7 AXIAL	CAC025			CAC043			
EFR7350	EFR7351	22,5"	KNORR SL7 AXIAL	CAC025			CAC043			
EFR7352	EFR7353	22,5"	KNORR SM7 AXIAL	CAC025			CAC043			
EFR7354	EFR7355	22,5"	KNORR ST7 AXIAL	CAC026			CAC043			
EFR7600	EFR7601	22,5"	MERITOR D3							
EFR7602	EFR7603	22,5"	MERITOR D3							
EFR7604	EFR7605	22,5"	MERITOR D3							
EFR7606	EFR7607	22,5"	MERITOR D3							
EFR7608	EFR7609	22,5"	MERITOR D3							

PIECES DETACHEES ETRIER DE FREIN CALIPER SPARE PARTS

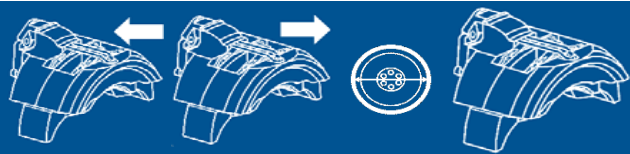


Autre /
other

Designation

				1	2	3 versions	1	2		
EFR7610	EFR7611	22,5"	MERITOR D LISA							
EFR7612	EFR7613	22,5"	MERITOR D LISA							
EFR7614	EFR7615	22,5"	MERITOR D LISA							
EFR7616	EFR7617	22,5"	MERITOR D DUCO AXIAL	CAC013					CAC001	Cache anti-poussière/Cap Gasket
EFR7618	EFR7619	17,5"	MERITOR B DUCO	CAC013			CAC011		CAC001	Cache anti-poussière/Cap Gasket
EFR7622	EFR7623	22,5"	MERITOR D DUCO AXIAL	CAC013			CAC011		CAC001	Cache anti-poussière/Cap Gasket
EFR7624	EFR7625	22,5"	MERITOR D DUCO RADIAL	CAC013			CAC011		CAC001	Cache anti-poussière/Cap Gasket
EFR7628	EFR7629	22,5"	MERITOR LE DUCO	CAC013			CAC011			
EFR7630	EFR7631	22,5"	MERITOR D DUCO AXIAL	CAC013			CAC011		CAC001	Cache anti-poussière/Cap Gasket
EFR7632	EFR7633	22,5"	MERITOR ELSA 1	CAC014						
EFR7634	EFR7635	22,5"	MERITOR ELSA 1	CAC014						
EFR7636	EFR7637	22,5"	MERITOR ELSA 1	CAC014						
EFR7638	EFR7639	22,5"	MERITOR ELSA 1	CAC014						
EFR7640	EFR7641	22,5"	MERITOR ELSA 1							
EFR7642	EFR7643	22,5"	MERITOR ELSA 1	CAC014						
EFR7644	EFR7645	22,5"	MERITOR ELSA 1	CAC014						
EFR7646	EFR7647	22,5"	MERITOR ELSA 1							
EFR7648	EFR7649	22,5"	MERITOR ELSA 1	CAC014						
EFR7652	EFR7653	22,5"	MERITOR D2							
EFR7658	EFR7659	22,5"	MERITOR D ELSA 2				CAC011		CAC001	Cache anti-poussière/Cap Gasket
EFR7660	EFR7661	22,5"	MERITOR D ELSA 2				CAC011		CAC001	Cache anti-poussière/Cap Gasket
EFR7664	EFR7665	22,5"	MERITOR D ELSA 2	CAC012			CAC011		CAC001	Cache anti-poussière/Cap Gasket
EFR7666	EFR7667	22,5"	MERITOR D ELSA 2	CAC012			CAC011		CAC001	Cache anti-poussière/Cap Gasket
EFR7668	EFR7669	22,5"	MERITOR D ELSA 2	CAC012			CAC011		CAC001	Cache anti-poussière/Cap Gasket
EFR7670	EFR7671	22,5"	MERITOR DX 225 (21-22)							
EFR7672	EFR7673	22,5"	MERITOR D ELSA 2	CAC012			CAC011		CAC001	Cache anti-poussière/Cap Gasket
EFR7674	EFR7675	22,5"	MERITOR D ELSA 2	CAC012			CAC011		CAC001	Cache anti-poussière/Cap Gasket
EFR7676	EFR7677	22,5"	MERITOR ELSA 225-3 RADIAL	CAC027			CAC011		CAC001	Cache anti-poussière/Cap Gasket
EFR7678	EFR7679	22,5"	MERITOR ELSA 225-3 AXIAL	CAC015			CAC011		CAC001	Cache anti-poussière/Cap Gasket

PIECES DETACHEES ETRIER DE FREIN CALIPER SPARE PARTS



Autre /
other

Designation

				1	2	3 versions	1	2		
EFR7680	EFR7681	22,5"	MERITOR ELSA 225-1 AXIAL	CAC028			CAC011		CAC001	Cache anti-poussière/Cap Gasket
EFR7684	EFR7685	22,5"	MERITOR D ELSA 2	CAC012			CAC011		CAC001	Cache anti-poussière/Cap Gasket
EFR7686	EFR7687	22,5"	MERITOR ELSA 225-3 AXIAL	CAC012			CAC011		CAC001	Cache anti-poussière/Cap Gasket
EFR7688	EFR7689	22,5"	MERITOR ELSA 225-3 AXIAL	CAC028			CAC011		CAC001	Cache anti-poussière/Cap Gasket
EFR7690	EFR7691	22,5"	MERITOR ELSA 225-1 AXIAL	CAC028			CAC011		CAC001	Cache anti-poussière/Cap Gasket
EFR7692	EFR7693	22,5"	MERITOR ELSA 2	CAC012			CAC011		CAC001	Cache anti-poussière/Cap Gasket
EFR7694	EFR7695	22,5"	MERITOR D ELSA 2	CAC012			CAC011		CAC001	Cache anti-poussière/Cap Gasket
EFR7696	EFR7697	22,5"	MERITOR ELSA 1	CAC014						
EFR7698	EFR7699	22,5"	MERITOR ELSA 2	CAC012			CAC011		CAC001	Cache anti-poussière/Cap Gasket
EFR7700	EFR7701	22,5"	MERITOR D ELSA 2	CAC012			CAC011		CAC001	Cache anti-poussière/Cap Gasket
EFR7702	EFR7703	22,5"	MERITOR ELSA 2	CAC012			CAC011		CAC001	Cache anti-poussière/Cap Gasket
EFR7704	EFR7705	22,5"	MERITOR ELSA 225L-2 AXIAL	CAC015			CAC011		CAC001	Cache anti-poussière/Cap Gasket
EFR7706	EFR7707	22,5"	MERITOR ELSA 2	CAC012			CAC011		CAC001	Cache anti-poussière/Cap Gasket
EFR7710	EFR7711	22,5"	MERITOR D2							
EFR7712	EFR7713	22,5"	MERITOR DX 225 (17-18)							
EFR7714	EFR7715	22,5"	MERITOR DX 225 (15-16)							
EFR7716	EFR7717	22,5"	MERITOR D ELSA 2	CAC012			CAC011		CAC001	Cache anti-poussière/Cap Gasket
EFR7718	EFR7719	22,5"	MERITOR D ELSA 2	CAC012			CAC011		CAC001	Cache anti-poussière/Cap Gasket
EFR7720	EFR7721	22,5"	MERITOR ELSA 2	CAC012			CAC011		CAC001	Cache anti-poussière/Cap Gasket
EFR7900	EFR7901	22,5"	BENDIX ADB 4300							
EFR7950	EFR7951	22,5"	BPW TSB4309 ECO DISC							
EFR7952	EFR7953	22,5"	BPW TSB4312 ECO DISC							
EFR7954	EFR7955	22,5"	BPW TS2 4309 ECO DISC							

ILLUSTRATIONS DRAWINGS

Reference

Illustrations / Drawings Designation



CAC001

CACHE ANTI-POUSSIÈRE /CAP GASKET MERITOR



CAC004

KIT ÉCROUS DE RÉGLAGE /ADJUSTER NUT KNORR

ILLUSTRATIONS DRAWINGS

Reference

Illustrations / Drawings Designation



CAC005

KIT AXES DE GUIDAGE ET ETANCHEITE /CALIPER GUIDE & SEALS KNORR



CAC006

RÉGLEUR COMPLET /ADJUSTER MECHANISM KNORR

ILLUSTRATIONS DRAWINGS

Reference

Illustrations / Drawings Designation



CAC007

KIT AXES DE GUIDAGE ET ETANCHEITE / CALIPER GUIDE & SEALS KNORR



CAC008

KIT POUSSOIRS ET SOUFFLETS / CALIPER BOOTS & PISTON REPAIR KIT KNORR

**ILLUSTRATIONS
DRAWINGS**

Reference

Illustrations / Drawings Designation



CAC009

KIT POUSSOIRS ET SOUFFLETS / CALIPER BOOTS & PISTON REPAIR KIT KNORR



CAC010

KIT AXES DE GUIDAGE ET ETANCHEITE / CALIPER GUIDE & SEALS KNORR

**ILLUSTRATIONS
DRAWINGS**

Reference

Illustrations / Drawings Designation



CAC011

KIT CACHE-POUSSIERES /ADJUSTER TAPPETS COVER MERITOR



CAC012

KIT AXES DE GUIDAGE ET ETANCHEITE /CALIPER GUIDE & SEALS MERITOR

**ILLUSTRATIONS
DRAWINGS**

Reference

Illustrations / Drawings Designation



CAC013

KIT AXES DE GUIDAGE ET ETANCHEITE /CALIPER GUIDE & SEALS MERITOR



CAC014

KIT AXES DE GUIDAGE ET ETANCHEITE/CALIPER GUIDE & SEALS MERITOR

**ILLUSTRATIONS
DRAWINGS**

Reference

Illustrations / Drawings Designation



CAC015

KIT AXES DE GUIDAGE ET ETANCHEITE /CALIPER GUIDE & SEALS MERITOR



CAC016

KIT AXES DE GUIDAGE ET ETANCHEITE /CALIPER GUIDE & SEALS MERITOR

**ILLUSTRATIONS
DRAWINGS**

Reference

Illustrations / Drawings Designation



CAC017

KIT AXES DE GUIDAGE ET ETANCHEITE /CALIPER GUIDE & SEALS WABCO



CAC018

KIT AXES DE GUIDAGE ET ETANCHEITE /CALIPER GUIDE & SEALS WABCO

**ILLUSTRATIONS
DRAWINGS**

Reference

Illustrations / Drawings Designation



CAC019

KIT AXES DE GUIDAGE ET ETANCHEITE /CALIPER GUIDE & SEALS WABCO



CAC020

PLAQUE COMPRESSION G /PUSH PLATE LEFT PAN 17 WABCO

Reference

Illustrations / Drawings Designation



CAC021

PLAQUE COMPRESSION D /PUSH PLATE RIGHT PAN 17 WABCO



CAC022

PLAQUE COMPRESSION G /PUSH PLATE LEFT PAN 19 WABCO



CAC023

PLAQUE COMPRESSION D /PUSH PLATE RIGHT PAN 19 WABCO

**ILLUSTRATIONS
DRAWINGS**

Reference

Illustrations / Drawings Designation



CAC024

KIT AXES DE GUIDAGE ET ETANCHEITE /CALIPER GUIDE & SEALS KNORR



CAC025

KIT AXES DE GUIDAGE ET ETANCHEITE /CALIPER GUIDE & SEALS KNORR

**ILLUSTRATIONS
DRAWINGS**

Reference

Illustrations / Drawings Designation



CAC026

KIT AXES DE GUIDAGE ET ETANCHEITE/CALIPER GUIDE & SEALS KNORR



CAC027

KIT AXES DE GUIDAGE ET ETANCHEITE /CALIPER GUIDE & SEALS MERITOR

**ILLUSTRATIONS
DRAWINGS**

Reference

Illustrations / Drawings Designation



CAC028

KIT AXES DE GUIDAGE ET ETANCHEITE /CALIPER GUIDE & SEALS MERITOR



CAC042

**KIT AXES DE GUIDAGE ET ETANCHEITE /CALIPER GUIDE & SEALS KNORR Rep.
CAC007, CAC010, CAC024**

**ILLUSTRATIONS
DRAWINGS**

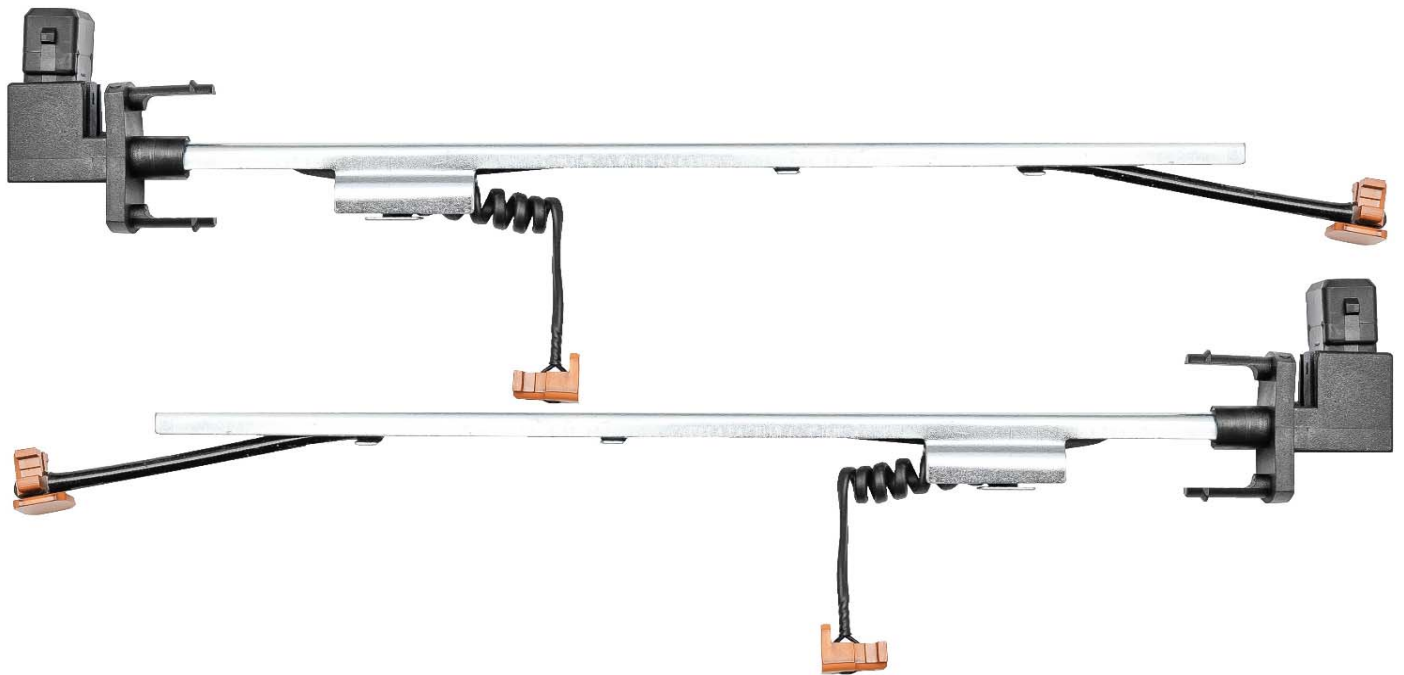
Reference

Illustrations / Drawings Designation



CAC043

KIT POUSSOIRS ET SOUFFLETS / CALIPER BOOTS & PISTON REPAIR KIT KNORR

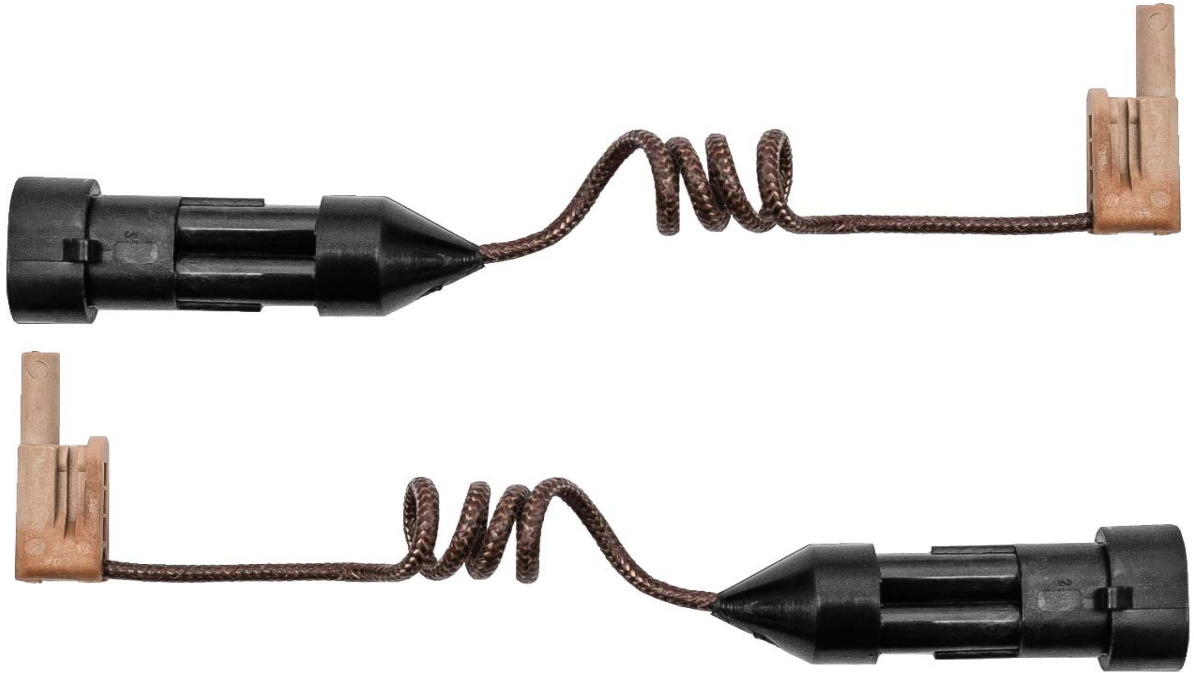


**W0226RT1
98025100**

TEMOINS USURE / WEAR INDICATOR RENAULT TRUCKS L.226 mm

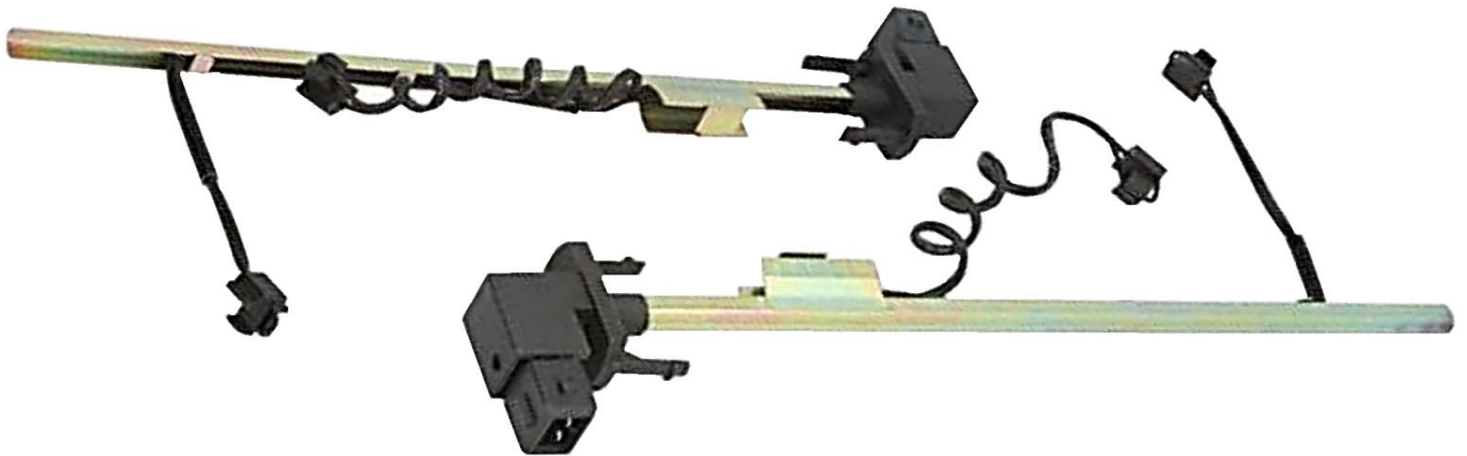
Reference

Illustrations / Drawings Designation



**W0250IV
98022500**

TEMOINS USURE /WEAR INDICATOR IVECO L.250 mm



**W0250RT
98025200**

TEMOINS USURE /WEAR INDICATOR RENAULT TRUCKS L.250 mm



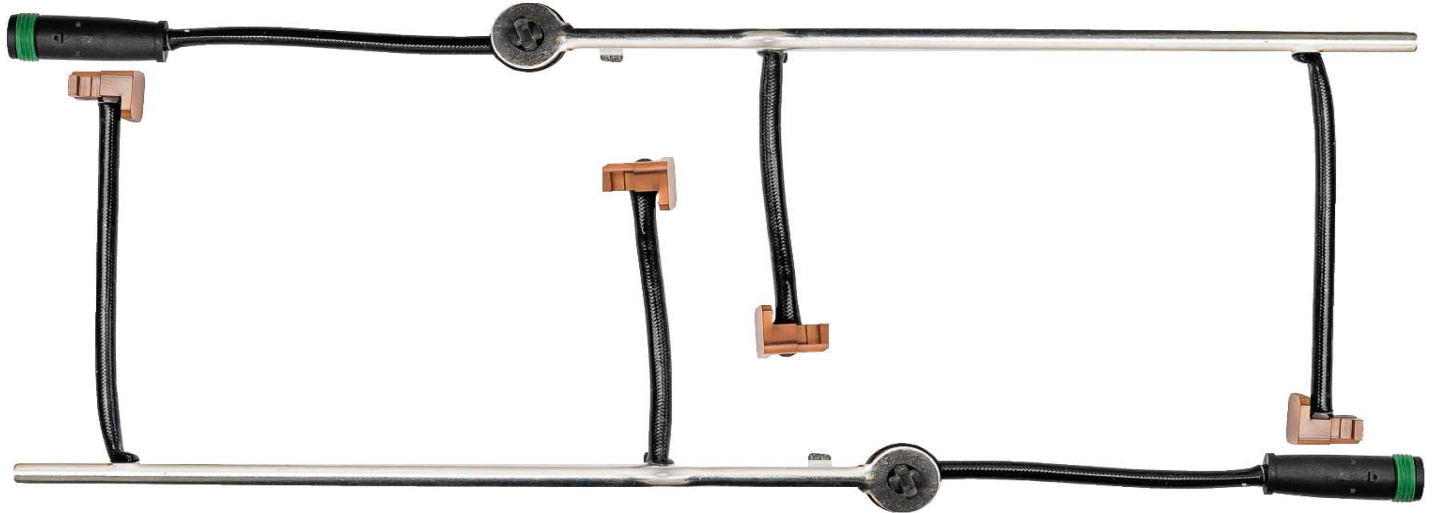
**W0280ME3
98017200**

TEMOINS USURE /WEAR INDICATOR MERCEDES L. 1x220 mm + 1 x 280 mm

**ILLUSTRATIONS
DRAWINGS**

Reference

Illustrations / Drawings Designation



**W0290MA1
98032400**

TEMOINS USURE /WEAR INDICATOR MAN L.290 mm

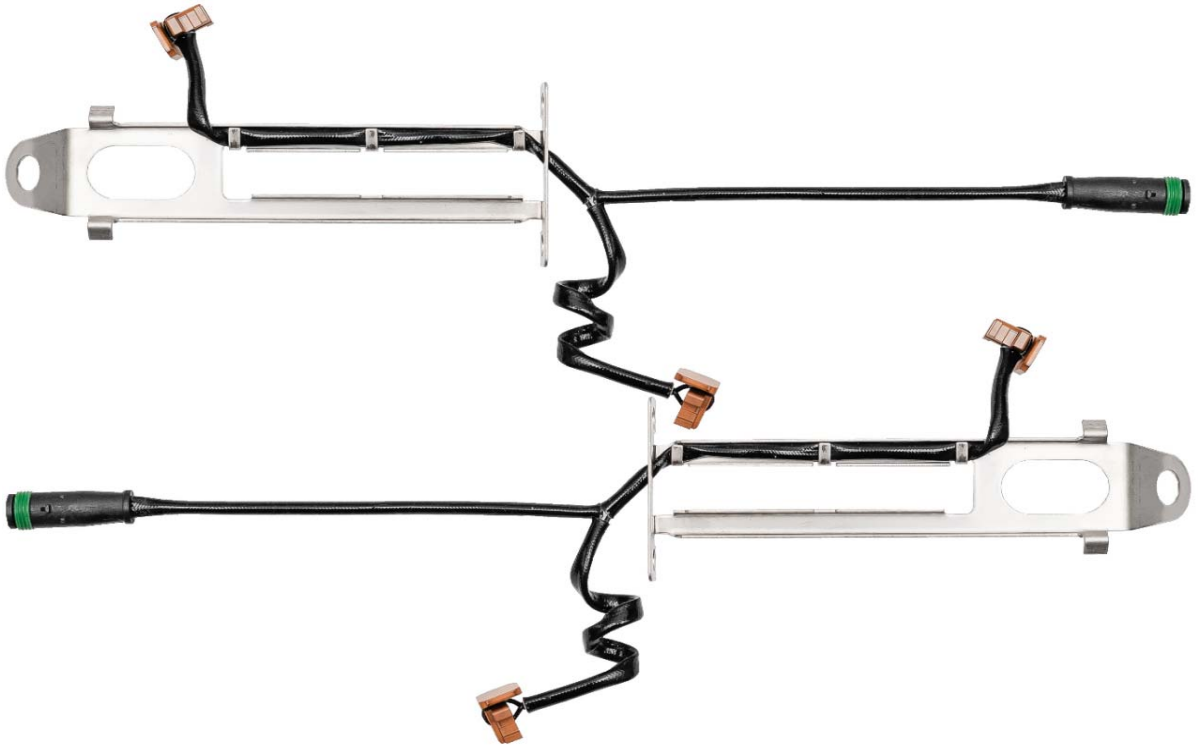


**W0290RO
98034500**

TEMOINS USURE /WEAR INDICATOR ROR DX195 L.290 mm

Reference

Illustrations / Drawings Designation



**W0295MA1
98024400**

TEMOINS USURE /WEAR INDICATOR MAN WABCO L.295 mm



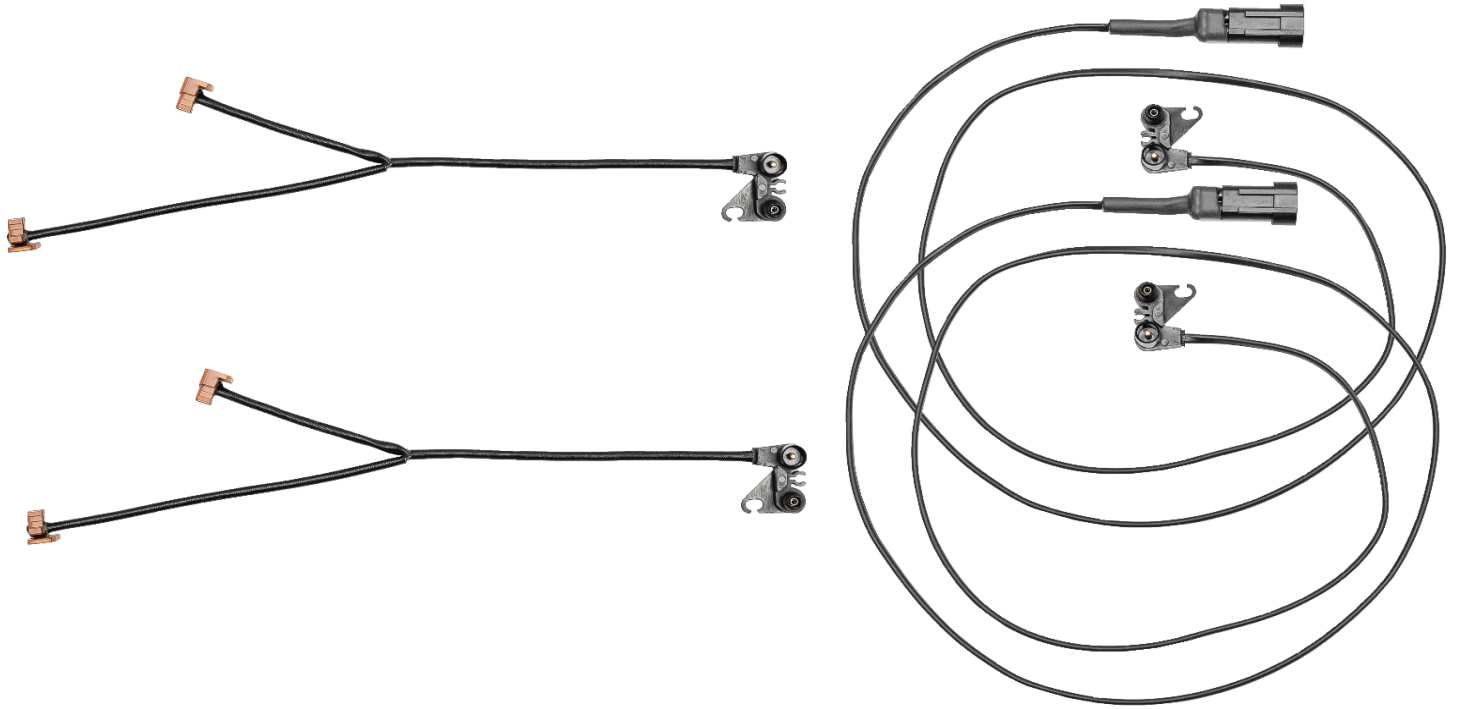
**W0300B1
98024100**

TEMOINS USURE /WEAR INDICATOR RENAULT TRUCKS WABCO L.300 mm

ILLUSTRATIONS DRAWINGS

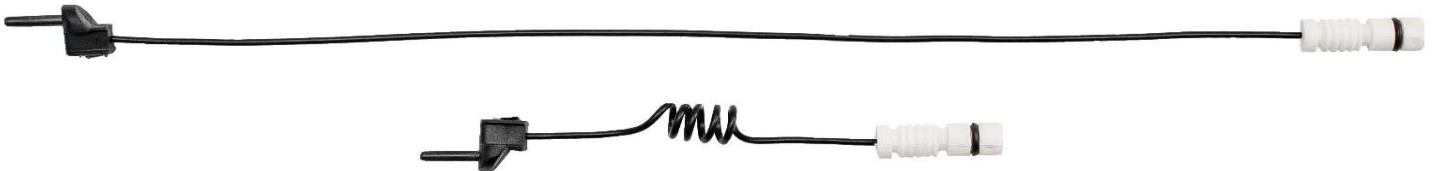
Reference

Illustrations / Drawings Designation



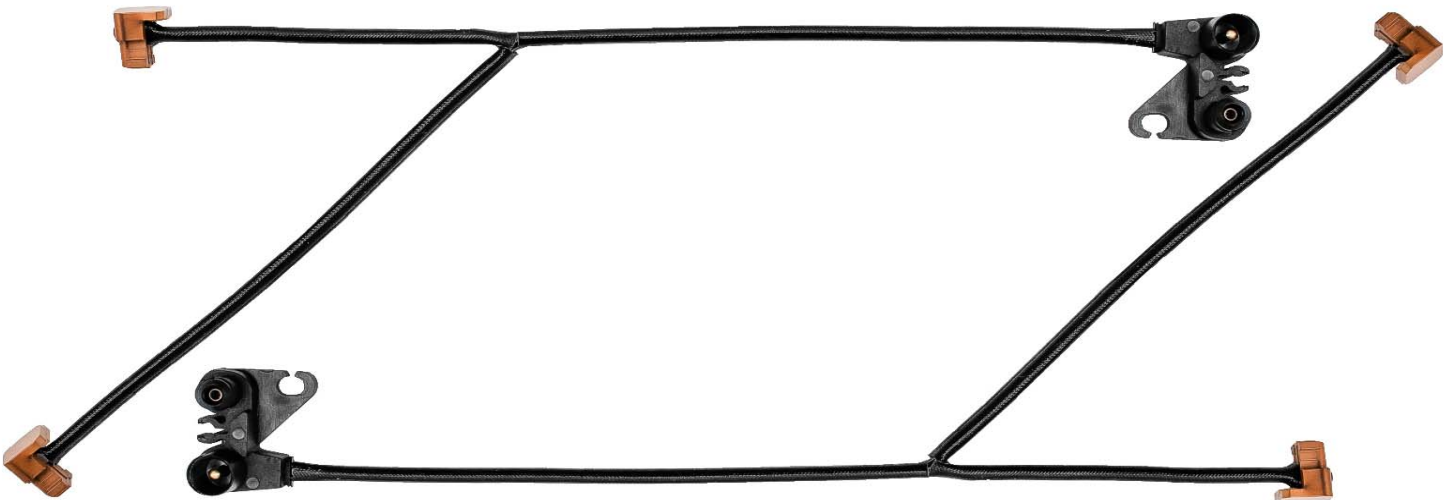
W0310IV34
98025300

TEMOINS USURE /WEAR INDICATOR IVECO L. 2 x 310 mm+ 2x 1300 mm



W0310NE3
98032300

TEMOINS USURE /WEAR INDICATOR NEOPLAN L. 1 x 230 mm + 1 x 310 mm



W0310SV4
98025400

TEMOINS USURE /WEAR INDICATOR IVECO BOVA SCANIA L.310 mm

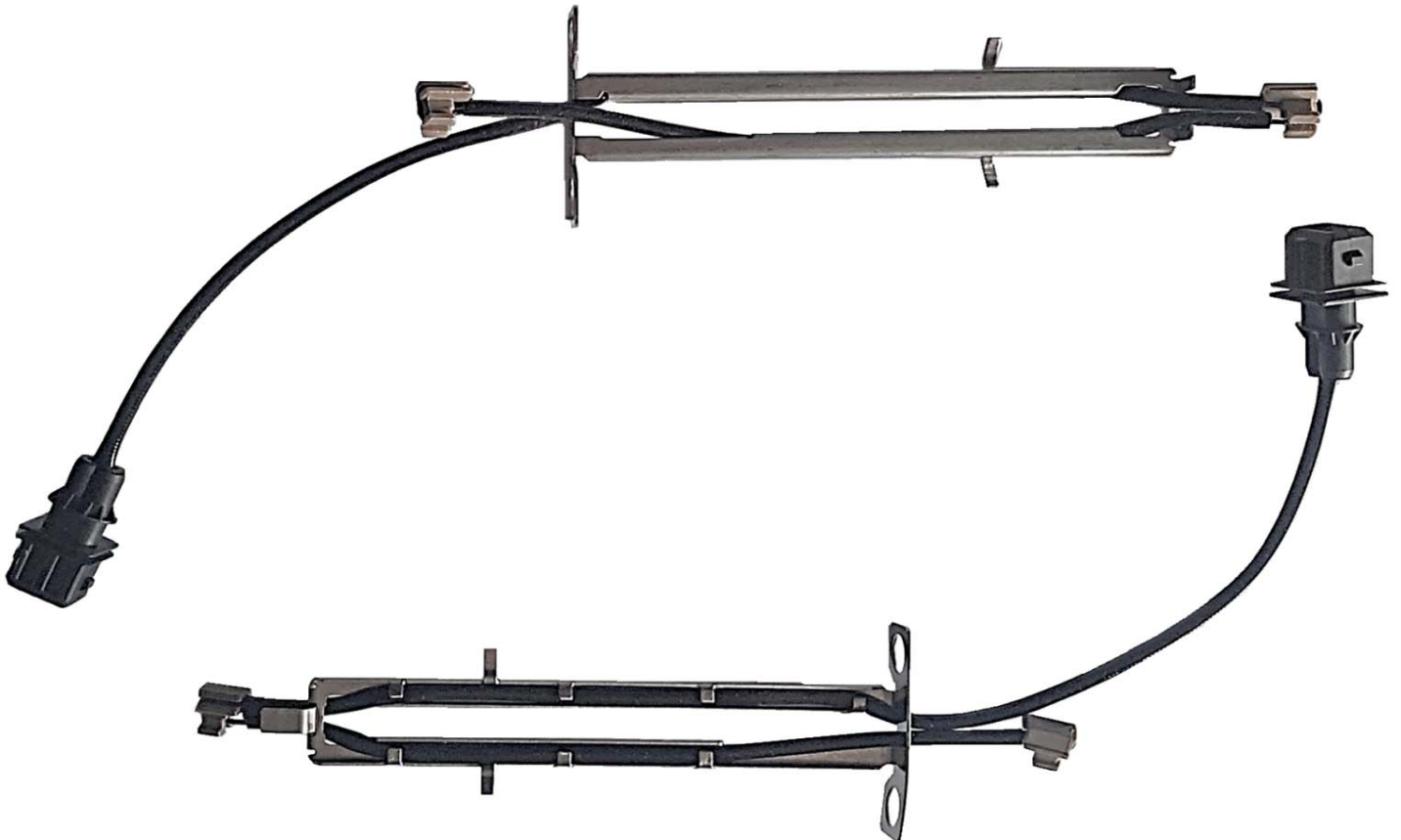
Reference

Illustrations / Drawings Designation



W0330DA1
98031600

TEMOINS USURE /WEAR INDICATOR DAF WABCO L.330 mm



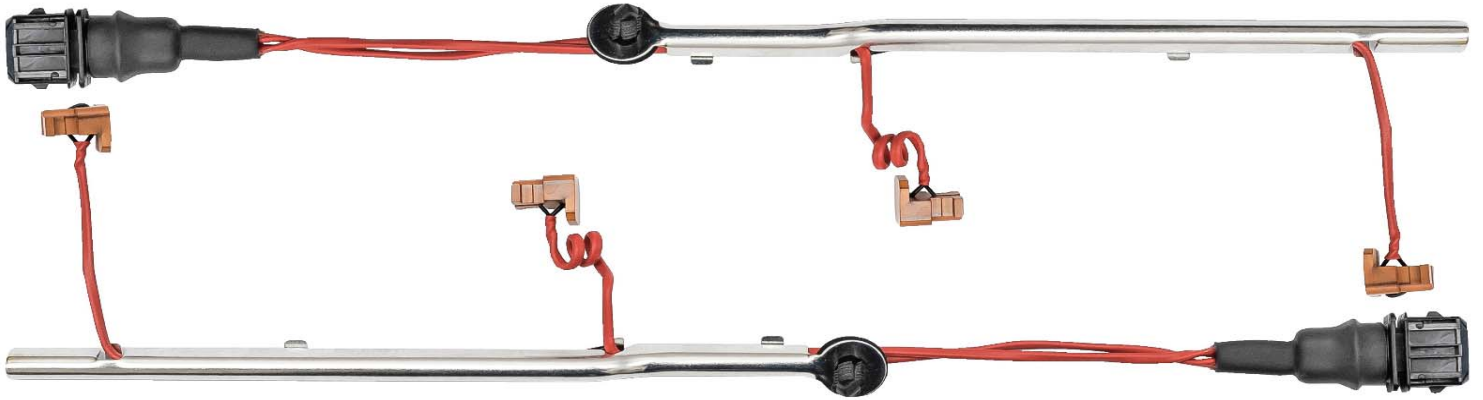
W0335RT1
98065500

TEMOINS USURE /WEAR INDICATOR RENAULT TRUCKS WABCO L.335 mm

**ILLUSTRATIONS
DRAWINGS**

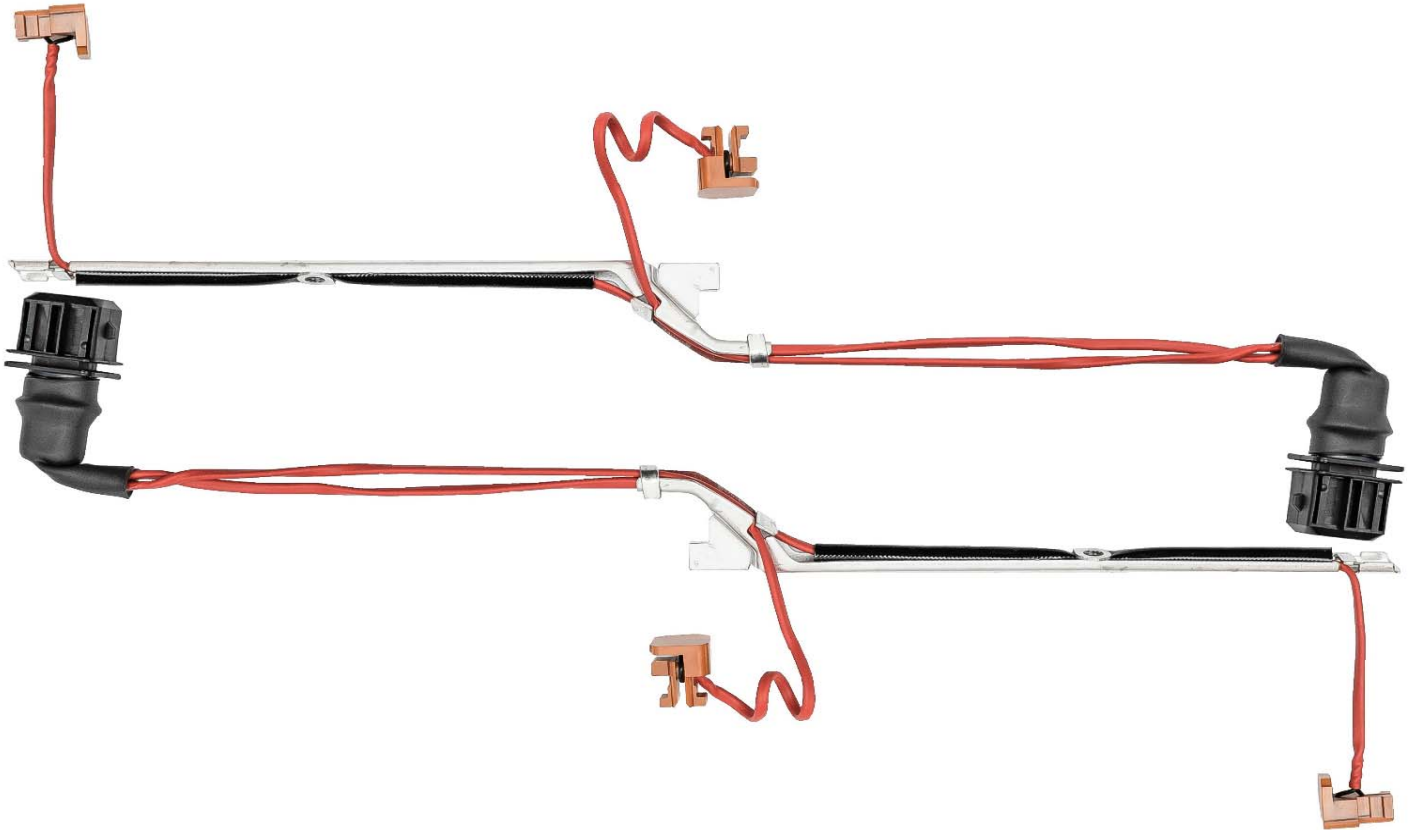
Reference

Illustrations / Drawings Designation



**W0355RT1V1
98027600**

TEMOINS USURE /WEAR INDICATOR RENAULT TRUCKS L.355 mm

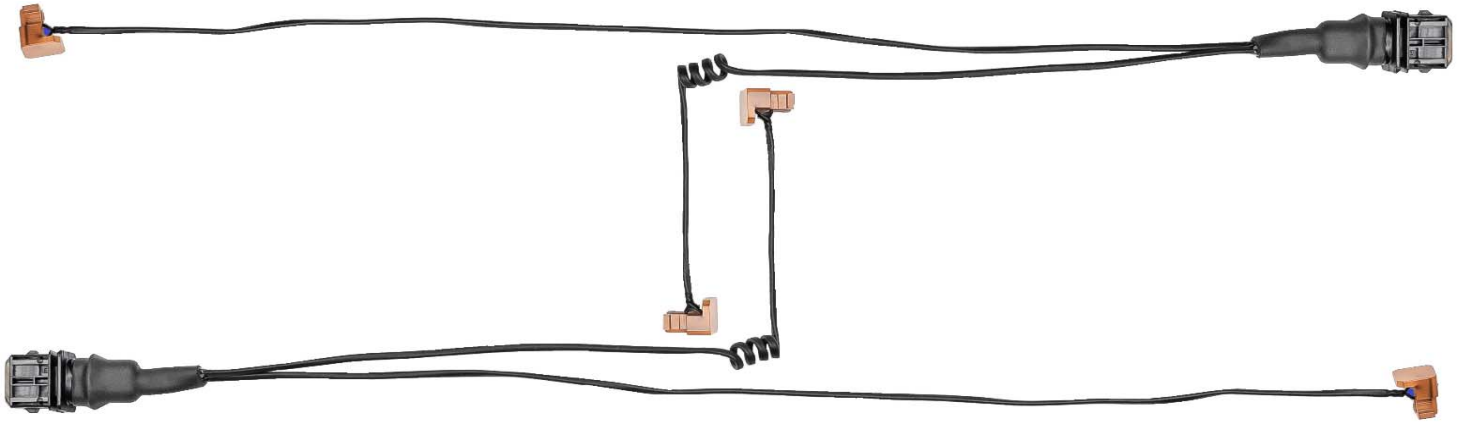


**W0355RT1V2
98028200
WIK538**

TEMOINS USURE /WEAR INDICATOR RENAULT TRUCKS L.355 mm

Reference

Illustrations / Drawings Designation



W0360RT
98025500

TEMOINS USURE /WEAR INDICATOR RT IRISBUS L.360 mm



W0360SA
98028800

TEMOINS USURE /WEAR INDICATOR SAE SAF L.360 mm

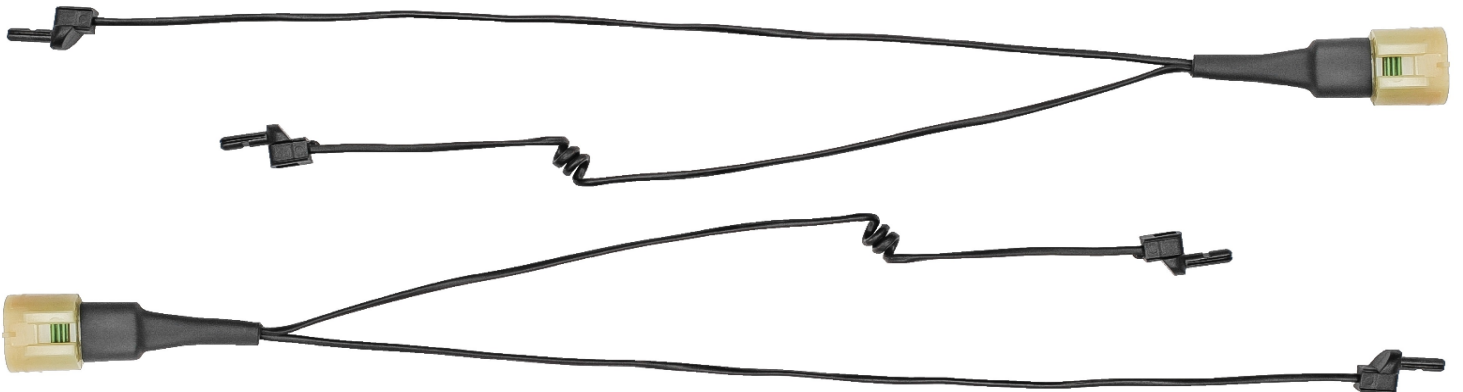
Reference

Illustrations / Drawings Designation



**W0365IV1
98031500**

TEMOINS USURE /WEAR INDICATOR IVECO WABCO L.365 mm



**W0365RT
98022800**

TEMOINS USURE /WEAR INDICATOR RT IRISBUS L.365 mm

Reference

Illustrations / Drawings Designation



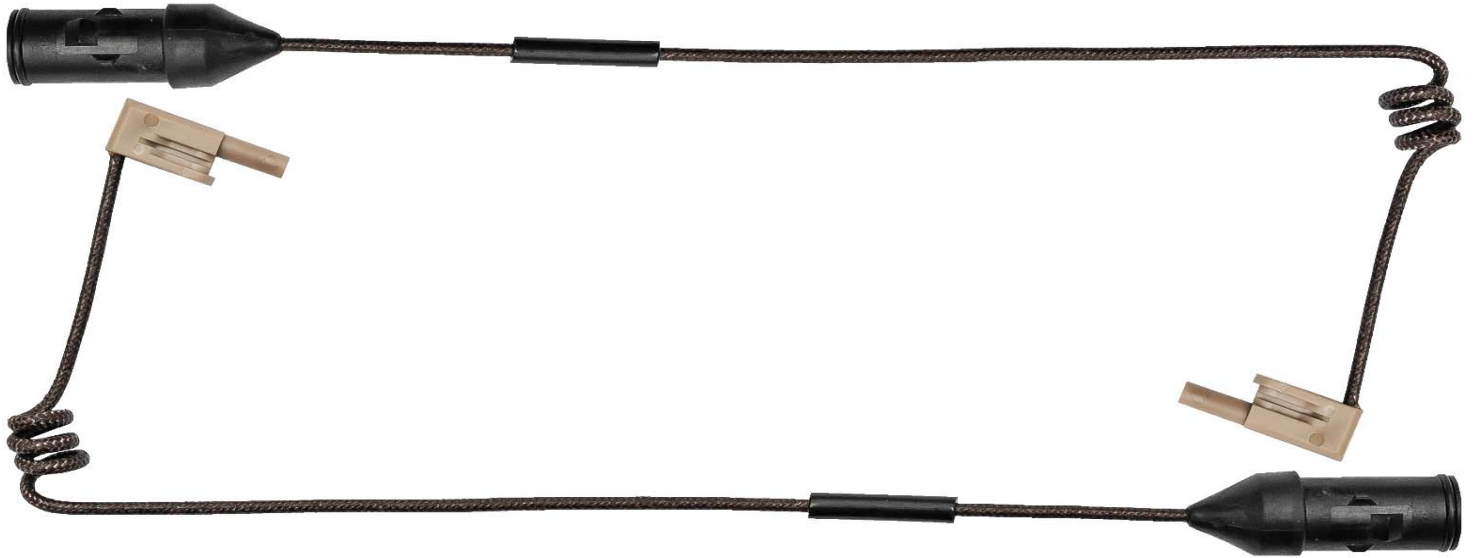
W0365RT2 TEMOINS USURE /WEAR INDICATOR RT L.365 mm



W0380DA1
98028600 TEMOINS USURE /WEAR INDICATOR DAF WABCO L.380 mm

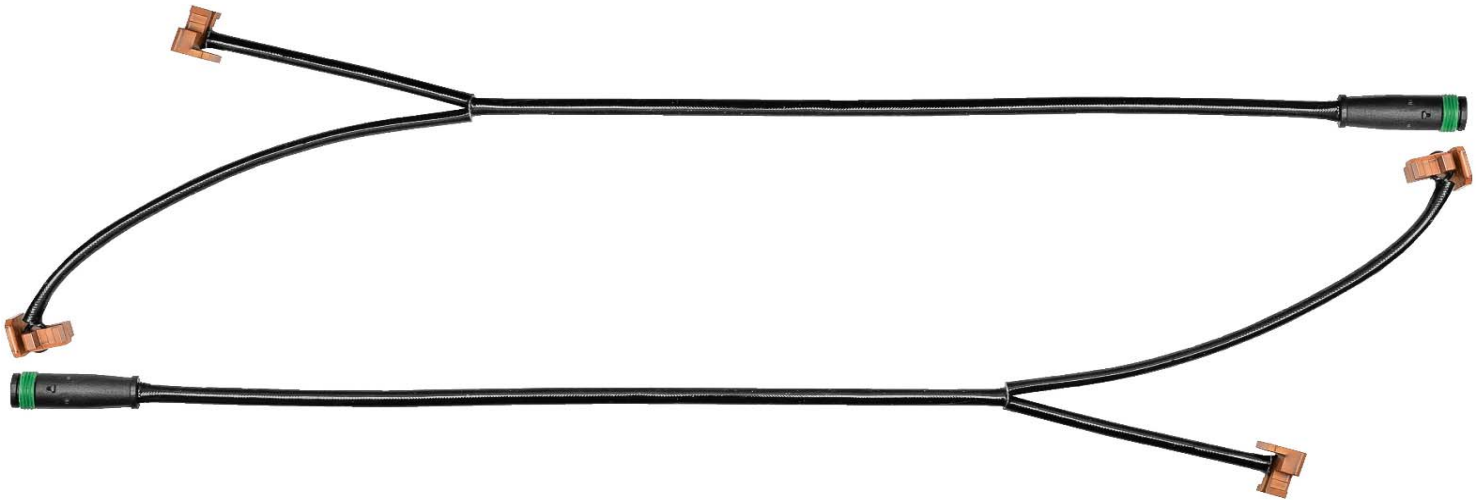
Reference

Illustrations / Drawings Designation



W0400IV
98022400

TEMOINS USURE /WEAR INDICATOR IVECO L.400 mm

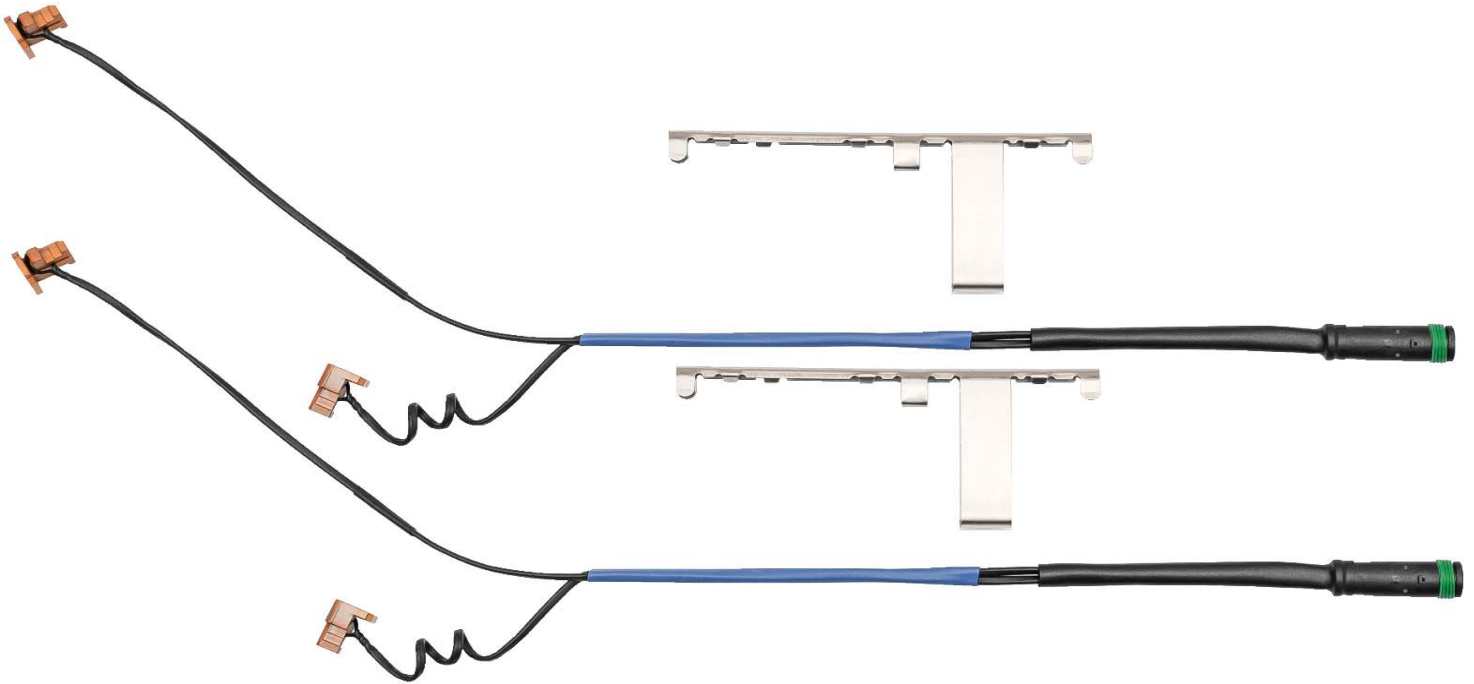


W0400MA
98032000

TEMOINS USURE /WEAR INDICATOR MAN L.400 mm

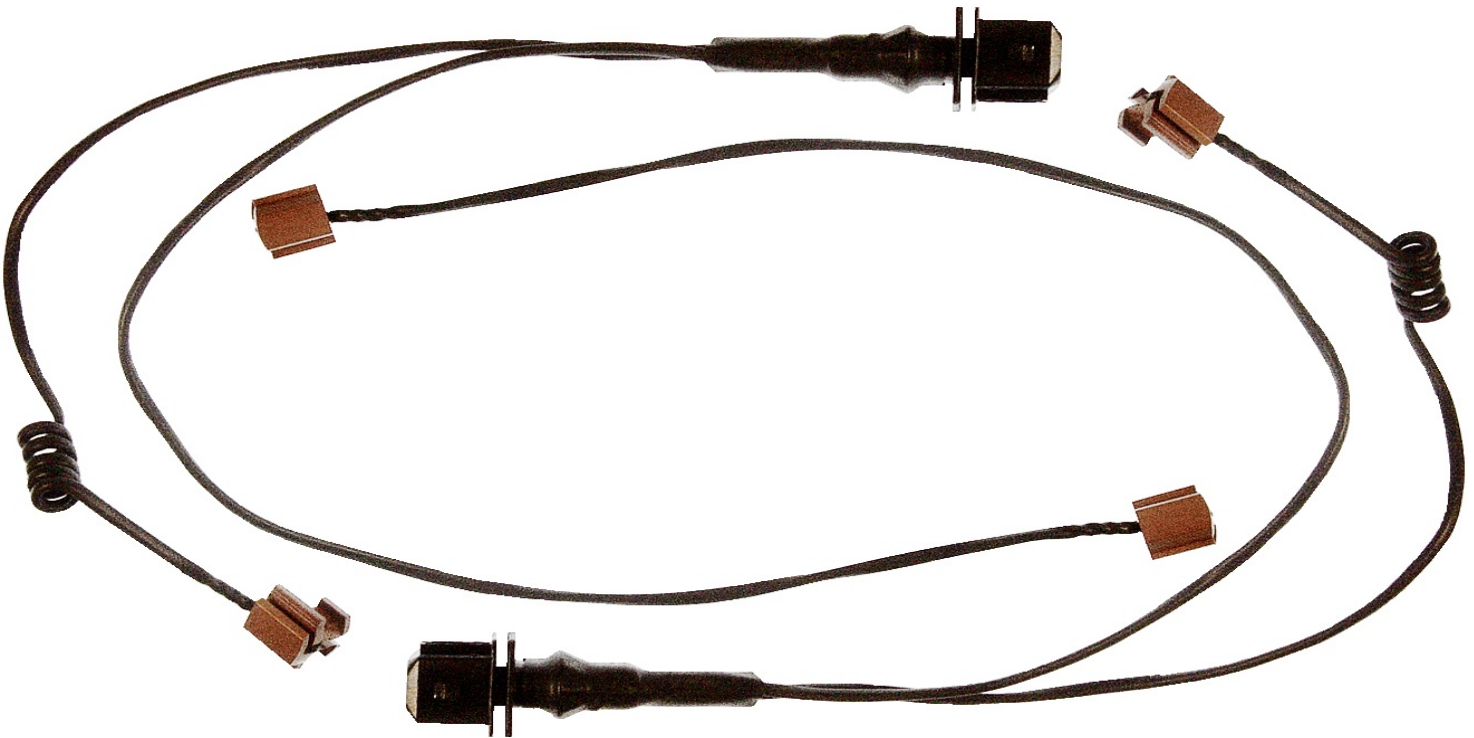
Reference

Illustrations / Drawings Designation



**W0400MA1
98024300**

TEMOINS USURE /WEAR INDICATOR MAN VAN HOOL L.400 mm

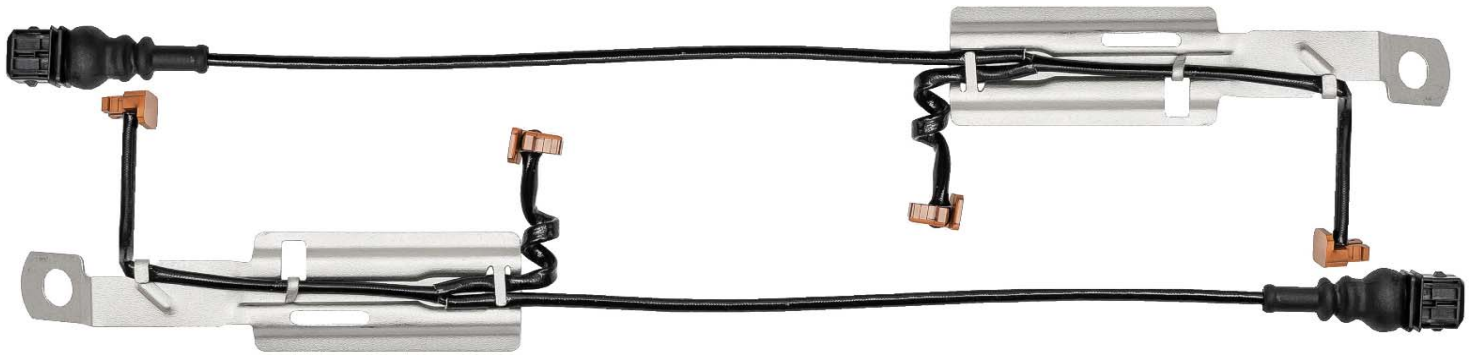


**W0400RT
98031900**

TEMOINS USURE /WEAR INDICATOR RENAULT TRUCKS L.400 mm

Reference

Illustrations / Drawings Designation



W0450RT1
98027500

TEMOINS USURE /WEAR INDICATOR RENAULT TRUCKS L.450 mm

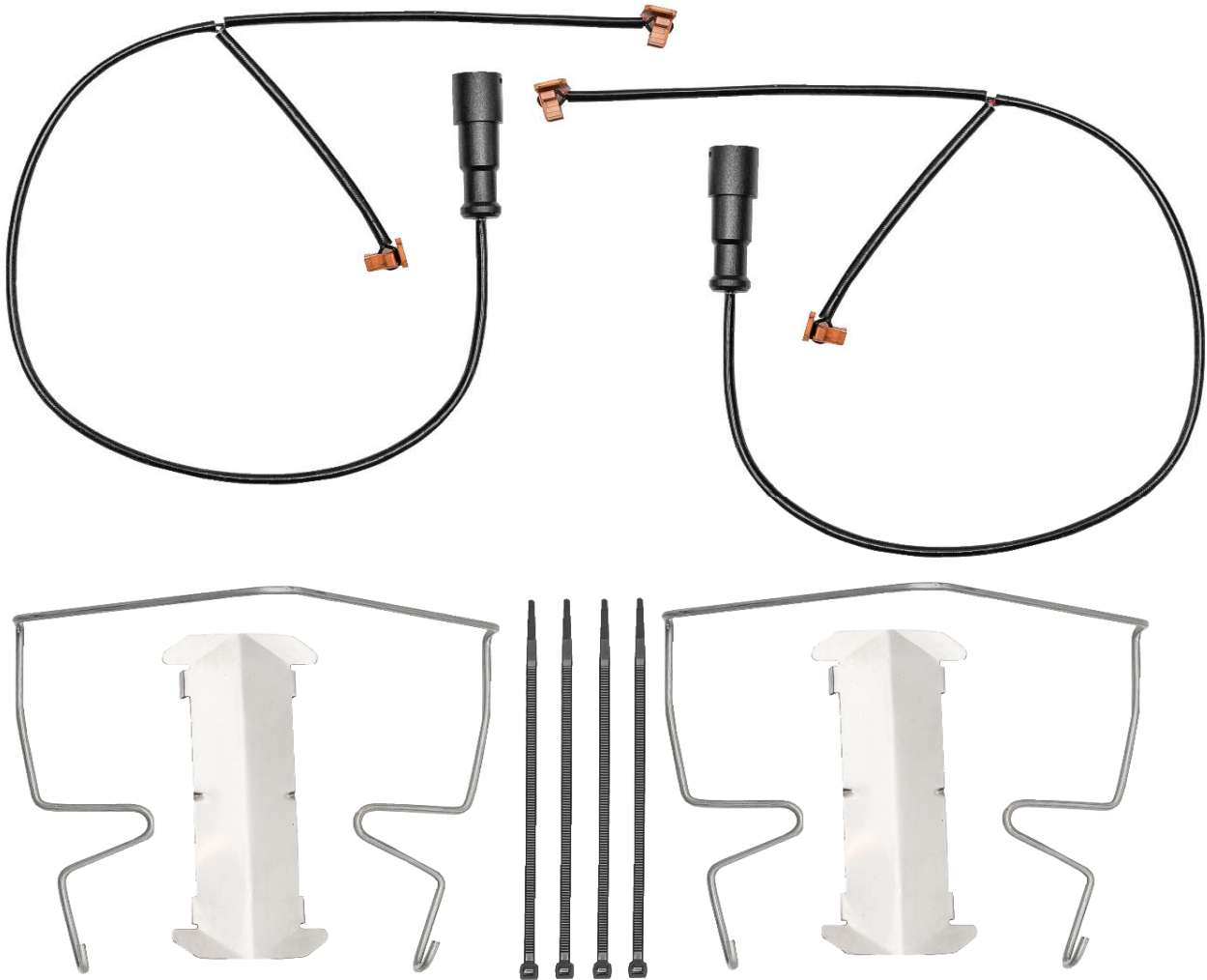


W0580RT
98028700

TEMOINS D'USURE /WEAR INDICATOR RENAULT TRUCKS 29043 L.580 mm

Reference

Illustrations / Drawings Designation

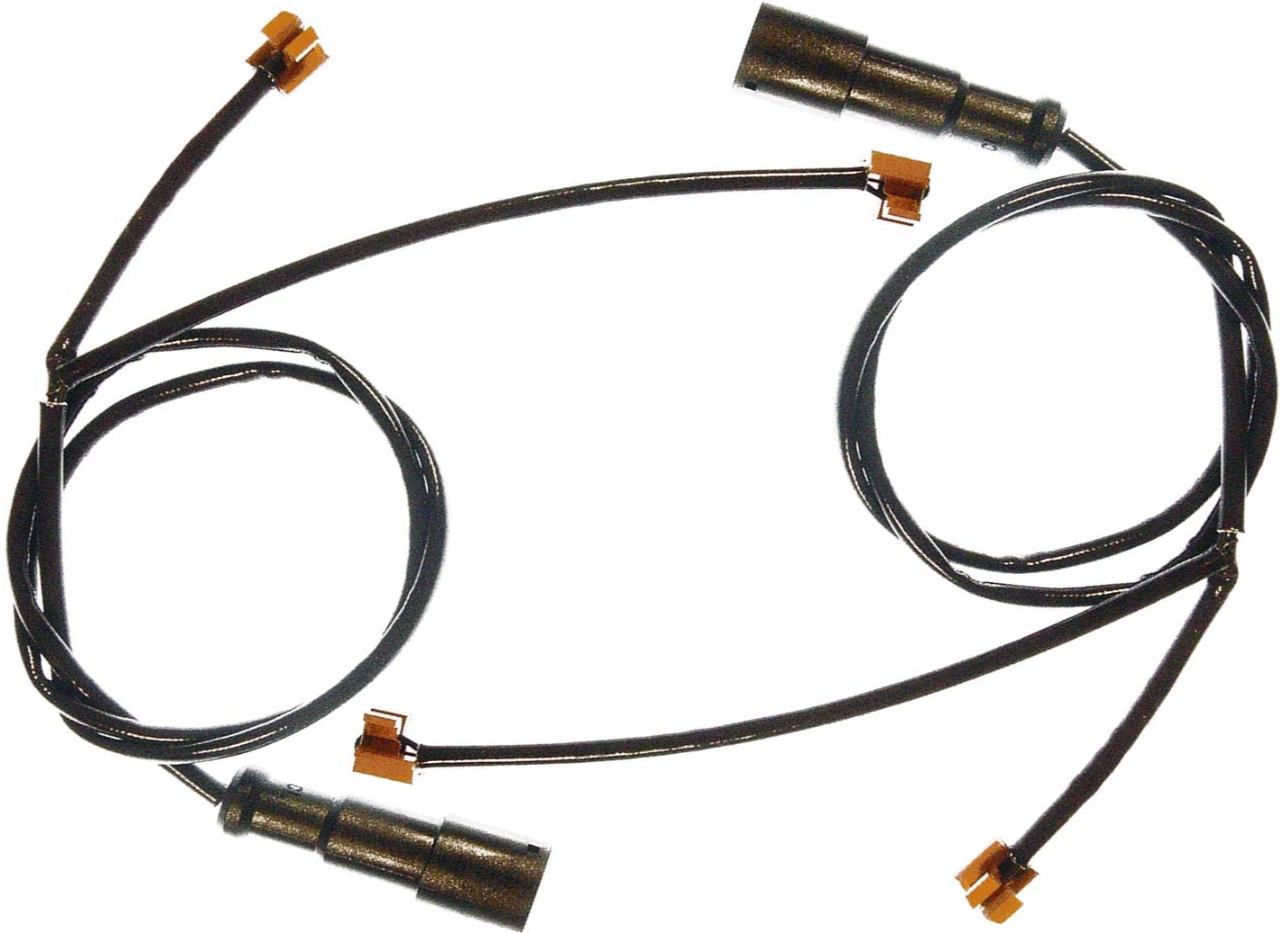


W0610SA

TEMOINS D'USRE /WEAR INDICATOR GIGANT SAF DBT19LT DBT22LT L.610 mm

Reference

Illustrations / Drawings Designation



W0760BP
98028900

TEMOINS USURE /WEAR INDICATOR BPW L.760 mm

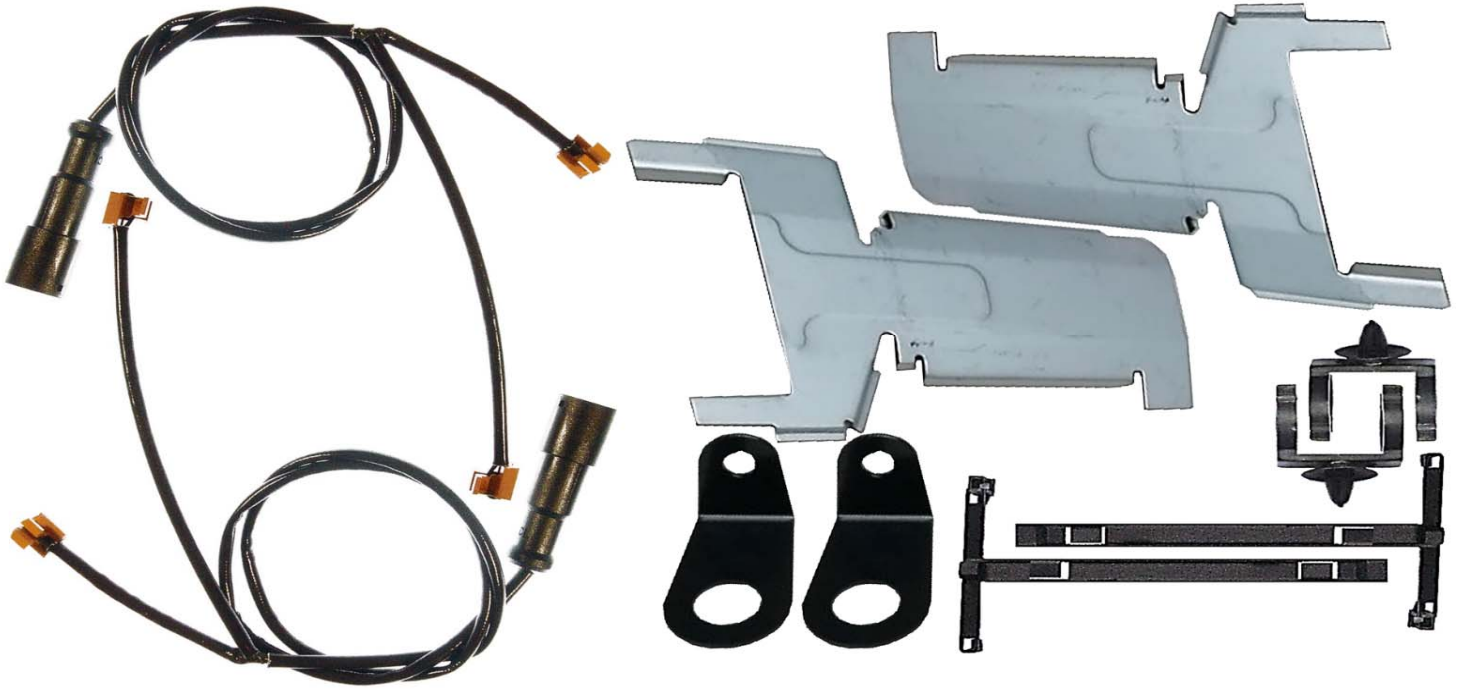


W0760SA

TEMOINS USURE /WEAR INDICATOR SAF L. 760 mm

Reference

Illustrations / Drawings Designation



W0940SABP

TEMOINS USURE /WEAR INDICATOR SAF BPW L. 940

CORRESPONDANCES DES REFERENCES CROSS REFERENCE LIST

MARQUE/MAKER	REF/PN OES	REF/PN	MARQUE/MAKER	REF/PN OES	REF/PN
ABEX	FAI101	98022800	ABEX	FAI202	98017000
ABEX	FAI101	W0365RT	ABEX	FAI203	98017100
ABEX	FAI105	W0250IV	ABEX	FAI205	98023500
ABEX	FAI107	98017200	ABEX	FAI206	98023600
ABEX	FAI108	98017600	ABEX	FAI207	98032200
ABEX	FAI110	98022400	ABEX	FAI208	98032100
ABEX	FAI110	W0400IV	ABEX	G6228	2907203
ABEX	FAI111	98028700	ABEX	G6397	2907503
ABEX	FAI113	98028400	ABEX	G6488	2903203
ABEX	FAI116	98025200	ABEX	G6500	2904303
ABEX	FAI117	98031900	ABEX	G6502	2901105
ABEX	FAI117	W0400RT	ABEX	G6515	2974703
ABEX	FAI119	98025000	ABEX	G6517	2908302
ABEX	FAI125	98025300	ABEX	G6517	CVP013K
ABEX	FAI125	W0310IV34	ABEX	G6644	2909006
ABEX	FAI126	98031500	ABEX	G6644	CVP023K
ABEX	FAI126	W0365IV1	ABEX	G6685	2905503
ABEX	FAI130	98032300	ABEX	G6687	2907702
ABEX	FAI132	98032000	ABEX	G6746FE	2936101
ABEX	FAI141	98025400	ABEX	G6746FE	CVP036K
ABEX	FAI150	W0295MA1	ABEX	G6753	2968801
ABEX	FAI151	98024100	ABEX	G6796FE	2918302
ABEX	FAI152	98031600	ABEX	G6812	2928503
ABEX	FAI152	W0330DA1	ABEX	G6812	CVP032K
ABEX	FAI160	98025300	ABEX	G6813	2936101
ABEX	FAI160	W0310IV34	ABEX	G6813	CVP036K
ABEX	FAI161	98024300	ABEX	G6813FE	2936101
ABEX	FAI162	98024300	ABEX	G6813FE	CVP036K
ABEX	FAI163	98027600	ABEX	G6814	2928503
ABEX	FAI163	W0355RT1V1	ABEX	G6814	CVP032K
ABEX	FAI164	98032400	ABEX	G6842	29154xx
ABEX	FAI164	W0290MA1	ABEX	G6843DFE	CVP020K
ABEX	FAI165	98041100	ABEX	G6887	2914302
ABEX	FAI166	98027500	ABEX	G6889	2913706
ABEX	FAI166	W0450RT1	ABEX	G6891	FCV1389
ABEX	FAI168	98028600	ABEX	G6898	2903007
ABEX	FAI168	W0380DA1	ABEX	G6898	CVP013K
ABEX	FAI169	98028200	ABEX	G6898FE	2903007
ABEX	FAI169	W0355RT1V2	ABEX	G6898FE	CVP013K
ABEX	FAI169	WIK538	ABEX	G6910FE	2920200604
ABEX	FAI171	98028800	ABEX	G6910FE	2927802
ABEX	FAI171	W0360SA	ABEX	G6910FE	CVP020K
ABEX	FAI172	98028900	ABEX	G6911FE	2911303
ABEX	FAI172	W0760BP	ABEX	G6912FE	2903007
ABEX	FAI173	98025300	ABEX	G6912FE	CVP013K
ABEX	FAI173	W0310IV34	ABEX	G6919	2927705
ABEX	FAI200	98016800	ABEX	G6919	CVP037K
ABEX	FAI201	98016900	ABEX	G6920FE	2913105

Les correspondances de références ont pour seul objectif d'aider la recherche de référence

Cross references are there for the sole purpose of helping the reference search

CORRESPONDANCES DES REFERENCES CROSS REFERENCE LIST

MARQUE/MAKER	REF/PN OES	REF/PN	MARQUE/MAKER	REF/PN OES	REF/PN
ABEX	G6920FE	CVP088K	ABEX	G6975	2931303
ABEX	G6921FE	2913105	ABEX	G6976	2931303
ABEX	G6921FE	CVP088K	ABEX	G6977	2931303
ABEX	G6922FE	2913103	ABEX	G6978PTS	2920200604
ABEX	G6922FE	CVP088K	ABEX	G6978PTS	2927801
ABEX	G6927	2905301	ABEX	G6979	2918701
ABEX	G6928	2911401	ABEX	G6980PTS	2920200604
ABEX	G6929	2918602	ABEX	G6980PTS	2927801
ABEX	G6930FE	2903009	ABEX	G6981PTS	2920200604
ABEX	G6930FE	CVP013K	ABEX	G6981PTS	2927802
ABEX	G6931	2905301	ABEX	G6981PTS	CVP020K
ABEX	G6932	2917705	ABEX	G6983FE	2920200604
ABEX	G6932	CVP095K	ABEX	G6983FE	2927802
ABEX	G6935	2933601	ABEX	G6983FE	CVP020K
ABEX	G6936	2926900604	ABEX	G6984	2917300604
ABEX	G6936	2926901	ABEX	G6984	2917301
ABEX	G6937	2930701	ABEX	G6984	CVP100K
ABEX	G6937	CVP093K	ABEX	G6985FE	2917400604
ABEX	G6938	2930601	ABEX	G6985FE	2917401
ABEX	G6939	2930801	ABEX	G6985FE	CVP101K
ABEX	G6939	CVP094K	ABEX	G6988	2927900604
ABEX	G6941FE	2932005	ABEX	G6988	2927901
ABEX	G6941FE	CVP036K	ABEX	G6990FE	2926900604
ABEX	G6942	2909006	ABEX	G6990FE	2926901
ABEX	G6942	CVP023K	ASHOK LEYLAND	445332035	EFR5002
ABEX	G6943FE	FCV4420B	ASHOK LEYLAND	445332036	EFR5003
ABEX	G6944FE	2918100604	ASHOK LEYLAND	X8827800	EFR5002
ABEX	G6944FE	2918101	ASHOK LEYLAND	X8827900	EFR5003
ABEX	G6945	2915001	ASTRA	98133542	CAC016
ABEX	G6951FE	2912405	BENDIX	131720	EFR7900
ABEX	G6951FE	CVP024K	BENDIX	131721	EFR7901
ABEX	G6953FE	2920200604	BENDIX	131776	EFR6902
ABEX	G6953FE	2927801	BENDIX	131777	EFR6903
ABEX	G6953FE	CVP020K	BENDIX	131790	EFR6900
ABEX	G6955	2915102	BENDIX	131791	EFR6901
ABEX	G6956	2927705	BMC	57RS301084	EFR5006
ABEX	G6956	CVP037K	BMC	57RS301085	EFR5007
ABEX	G6957	2931303	BMC	57RS305068	EFR6300
ABEX	G6958	2910004	BMC	57RS305148	EFR6301
ABEX	G6959HD	2920200604	BMC	57RS306181	EFR6300
ABEX	G6959HD	2927802	BMC	57RS306182	EFR6301
ABEX	G6959HD	CVP020K	BMC	57RS307767	EFR7310
ABEX	G6960	2931303	BMC	57RS307768	EFR7311
ABEX	G6964	2917705	BMC	57RS309174	EFR6306
ABEX	G6964	CVP095K	BMC	57RS309175	EFR6307
ABEX	G6974	2928502	BMC	57RS309343	EFR7308
ABEX	G6974	CVP032K	BMC	57RS309344	EFR7309
ABEX	G6975	2931302	BMC	57RS309846	EFR7302

Les correspondances de références ont pour seul objectif d'aider la recherche de référence

Cross references are there for the sole purpose of helping the reference search

CORRESPONDANCES DES REFERENCES CROSS REFERENCE LIST

MARQUE/MAKER	REF/PN OES	REF/PN	MARQUE/MAKER	REF/PN OES	REF/PN
BMC	57RS309847	EFR7303	BOVA	4200172	FCR168A
BOLWELL	35403112182	CAC011	BPW	0203121400	2920200604
BOLWELL	35403112205	CAC012	BPW	0203121400	2927801
BOLWELL	35403127373	2912405	BPW	0203121700	2920200604
BOLWELL	35403127373	CVP024K	BPW	0203121700	2927801
BOLWELL	35503109502	CAC030	BPW	0206081400	CAC008
BOLWELL	CF103915	2912405	BPW	0206081500	CAC009
BOLWELL	CF103915	CVP024K	BPW	0206110500	CAC009
BOLWELL	CF104034	2927705	BPW	0206110600	CAC008
BOLWELL	CF104034	CVP037K	BPW	0224001100	CAC004
BOLWELL	CF104299	CAC001	BPW	0300224093	09.8486.20
BOLWELL	CF104300	CAC012	BPW	0308834010	09.9754.10
BOLWELL	CF104301	CAC011	BPW	0308834010	92116300
BOLWELL	CF104440	2917705	BPW	0308834010	FCR206A
BOLWELL	CF104440	CVP095K	BPW	0308834017	09.9754.10
BOLWELL	CF104443	CAC015	BPW	0308834017	92116300
BOLWELL	CF104609	2913706	BPW	0308834017	FCR206A
BOLWELL	STRMDP5053	2913706	BPW	0308834020	09.8486.20
BOVA	0299095	93084000	BPW	0308834030	09.9754.10
BOVA	0299095	FCR100A	BPW	0308834030	92116300
BOVA	1238372	93084000	BPW	0308834030	FCR206A
BOVA	1238372	FCR100A	BPW	0308834037	09.9754.10
BOVA	14000552	EFR7302	BPW	0308834037	92116300
BOVA	14000553	EFR7303	BPW	0308834037	FCR206A
BOVA	204552	2920200604	BPW	0308834040	09.8486.20
BOVA	204552	2925305390	BPW	0308834040	93104900
BOVA	204552	2927802	BPW	0308834040	FCR205A
BOVA	204552	CVP020K	BPW	0308834047	09.8486.20
BOVA	204566	09.8129.20	BPW	0308834047	93104900
BOVA	204566	93058100	BPW	0308834047	FCR205A
BOVA	204566	FCR114A	BPW	0308834060	09.8486.20
BOVA	221412	93084000	BPW	0308834067	09.8486.20
BOVA	221412	93086700	BPW	0308834070	FCR280A
BOVA	221412	FCR100A	BPW	0308834077	FCR280A
BOVA	221412	FCR167A	BPW	0308834080	09.9900.10
BOVA	234110	09.B325.40	BPW	0308834080	92116500
BOVA	234110	93086800	BPW	0308834080	FCR210A
BOVA	234110	FCR168A	BPW	0308834087	09.9900.10
BOVA	267633	EFR7302	BPW	0308834087	92116500
BOVA	267634	EFR7303	BPW	0308834087	FCR210A
BOVA	33985	09.8129.20	BPW	0308834090	09.9754.10
BOVA	33985	93058100	BPW	0308834090	92116300
BOVA	33985	FCR114A	BPW	0308834090	FCR206A
BOVA	37257	09.8129.20	BPW	0308834097	09.9754.10
BOVA	37257	93058100	BPW	0308834097	92116300
BOVA	37257	FCR114A	BPW	0308834097	FCR206A
BOVA	4200172	09.B325.40	BPW	0308834100	09.A594.20
BOVA	4200172	93086800	BPW	0308834100	93126900

Les correspondances de références ont pour seul objectif d'aider la recherche de référence

Cross references are there for the sole purpose of helping the reference search

CORRESPONDANCES DES REFERENCES CROSS REFERENCE LIST

MARQUE/MAKER	REF/PN OES	REF/PN	MARQUE/MAKER	REF/PN OES	REF/PN
BPW	0308834100	FCR252A	BPW	040290010	EFR7305
BPW	0308834107	09.A594.20	BPW	040290020	EFR7304
BPW	0308834107	93126900	BPW	040290090	EFR7304
BPW	0308834107	FCR252A	BPW	040290100	EFR7305
BPW	0308834130	09.A594.20	BPW	040290110	EFR7304
BPW	0308834130	93127000	BPW	040290120	EFR7305
BPW	0308834130	FCR253A	BPW	0500061134	EFR6300
BPW	0308834137	09.A594.20	BPW	0500061135	EFR6301
BPW	0308834137	93127000	BPW	0509290040	2930601
BPW	0308834137	FCR253A	BPW	0509290050	2930601
BPW	0308834140	09.A594.20	BPW	0509290060	2930801
BPW	0308834140	93126900	BPW	0509290060	CVP094K
BPW	0308834140	FCR252A	BPW	0509290070	2930701
BPW	0308834147	09.A594.20	BPW	0509290070	CVP093K
BPW	0308834147	93126900	BPW	0509290080	2930801
BPW	0308834147	FCR252A	BPW	0509290080	CVP094K
BPW	0308834160	09.9754.10	BPW	0509290090	2930701
BPW	0308834160	92116300	BPW	0509290090	CVP093K
BPW	0308834160	FCR206A	BPW	0509290100	2930601
BPW	0308834167	09.9754.10	BPW	0509290120	2922701
BPW	0308834167	92116300	BPW	0509290121	2922701
BPW	0308834167	FCR206A	BPW	0509290130	2922800604
BPW	0308834210	09.A594.20	BPW	0509290130	2922801
BPW	0308834210	93126900	BPW	0509290131	2922800604
BPW	0308834210	FCR252A	BPW	0509290131	2922801
BPW	0308834217	09.A594.20	BPW	0509290151	2922701
BPW	0308834217	93126900	BPW	0509290201	29267xx
BPW	0308834217	FCR252A	BPW	0509290220	2930601
BPW	0308835010	09.7383.20	BPW	0509290230	2930801
BPW	0308835010	93095900	BPW	0509290230	CVP094K
BPW	0308835017	09.7383.20	BPW	0509290240	2930701
BPW	0308835017	93095900	BPW	0509290240	CVP093K
BPW	0308835030	09.B072.10	BPW	0509290250	2940301
BPW	0308835030	93127100	BPW	0509290260	2940301
BPW	0308835030	FCR222A	BPW	0509290290	2940501
BPW	0308835037	09.B072.10	BPW	0509290300	2940501
BPW	0308835037	93127100	BPW	0509290331	2922800604
BPW	0308835037	FCR222A	BPW	0509290331	2922801
BPW	0308835050	09.B072.10	BPW	0536270010	2920200604
BPW	0308835050	93127100	BPW	0536270010	2927801
BPW	0308835050	FCR222A	BPW	0536270010	EFR7302
BPW	0308835057	09.B072.10	BPW	0536270020	2920200604
BPW	0308835057	93127100	BPW	0536270020	2925305390
BPW	0308835057	FCR222A	BPW	0536270020	2927801
BPW	0308835120	DF713848	BPW	0536270020	2930701
BPW	0308835127	DF713848	BPW	0536270020	CVP020K
BPW	0308835128	DF713848	BPW	0536270020	CVP093K
BPW	040290000	09.7380.30	BPW	0536270020	EFR7303

Les correspondances de références ont pour seul objectif d'aider la recherche de référence

Cross references are there for the sole purpose of helping the reference search

CORRESPONDANCES DES REFERENCES CROSS REFERENCE LIST

MARQUE/MAKER	REF/PN OES	REF/PN	MARQUE/MAKER	REF/PN OES	REF/PN
BPW	0536270120	EFR7302	BPW	0536270370	EFR6301
BPW	05362701200	EFR7302	BPW	05362703700	EFR6301
BPW	0536270130	EFR7303	BPW	0536270371	EFR6301
BPW	05362701300	EFR7303	BPW	05362703710	EFR6301
BPW	0536270160	EFR6300	BPW	0536270372	EFR6301
BPW	05362701600	EFR6300	BPW	05362703720	EFR6301
BPW	0536270170	EFR6301	BPW	0536270380	EFR7303
BPW	05362701700	EFR6301	BPW	05362703800	EFR7303
BPW	0536270220	EFR6302	BPW	0536270381	EFR7303
BPW	05362702200	EFR6302	BPW	0536270382	EFR7303
BPW	0536270221	EFR6302	BPW	05362703820	EFR7303
BPW	0536270222	EFR6302	BPW	0536270390	EFR7302
BPW	0536270230	EFR6303	BPW	05362703900	EFR7302
BPW	0536270231	EFR6303	BPW	0536270391	EFR7302
BPW	0536270232	EFR6303	BPW	0536270392	EFR7302
BPW	05362702320	EFR6303	BPW	05362703920	EFR7302
BPW	0536270240	EFR7303	BPW	0536270400	EFR6302
BPW	05362702400	EFR7303	BPW	05362704000	EFR6302
BPW	0536270241	EFR7303	BPW	0536270401	EFR6302
BPW	0536270250	EFR7302	BPW	0536270410	EFR6303
BPW	05362702500	EFR7302	BPW	05362704100	EFR6303
BPW	0536270251	EFR7302	BPW	0536270411	EFR6303
BPW	0536270252	EFR7302	BPW	0536270420	EFR7302
BPW	0536270260	EFR6300	BPW	05362704200	EFR7302
BPW	05362702600	EFR6300	BPW	0536270421	EFR7302
BPW	0536270261	EFR6300	BPW	0536270422	EFR7302
BPW	05362702610	EFR6300	BPW	0536270423	EFR7302
BPW	0536270262	EFR6300	BPW	0536270430	EFR7303
BPW	05362702620	EFR6300	BPW	05362704300	EFR7303
BPW	0536270270	EFR6301	BPW	0536270431	EFR7303
BPW	05362702700	EFR6301	BPW	0536270432	EFR7303
BPW	0536270271	EFR6301	BPW	0536270433	EFR7303
BPW	05362702710	EFR6301	BPW	0536270600	EFR6301
BPW	0536270272	EFR6301	BPW	05362706000	EFR6301
BPW	05362702720	EFR6301	BPW	05362706010	EFR6301
BPW	05362702722	EFR6301	BPW	0536270602	EFR6301
BPW	0536270320	EFR7303	BPW	0536270603	EFR6301
BPW	05362703200	EFR7303	BPW	0536270604	EFR6301
BPW	0536270330	EFR7302	BPW	0536270610	EFR6300
BPW	05362703300	EFR7302	BPW	05362706100	EFR6300
BPW	0536270340	EFR7302	BPW	0536270612	EFR6300
BPW	0536270350	EFR7303	BPW	05362706120	EFR6300
BPW	0536270360	EFR6300	BPW	0536270613	EFR6300
BPW	05362703600	EFR6300	BPW	0536270614	EFR6300
BPW	0536270361	EFR6300	BPW	0536270620	EFR6309
BPW	05362703610	EFR6300	BPW	05362706200	EFR6309
BPW	0536270362	EFR6300	BPW	0536270621	EFR6309
BPW	05362703620	EFR6300	BPW	05362706210	EFR6309

Les correspondances de références ont pour seul objectif d'aider la recherche de référence

Cross references are there for the sole purpose of helping the reference search

CORRESPONDANCES DES REFERENCES CROSS REFERENCE LIST

MARQUE/MAKER	REF/PN OES	REF/PN	MARQUE/MAKER	REF/PN OES	REF/PN
BPW	0536270630	EFR6308	BPW	0936272020	EFR7951
BPW	05362706300	EFR6308	BPW	0936272021	EFR7951
BPW	0536270631	EFR6308	BPW	0936272030	EFR6950
BPW	05362706310	EFR6308	BPW	0936272031	EFR6950
BPW	0536270640	EFR7303	BPW	0936272040	EFR6951
BPW	05362706400	EFR7303	BPW	0936272041	EFR6951
BPW	0536270642	EFR7303	BPW	0936272050	EFR7952
BPW	0536270643	EFR7303	BPW	0936272060	EFR7953
BPW	05362706430	EFR7303	BPW	0936272110	EFR7950
BPW	0536270650	EFR7302	BPW	0936272111	EFR7950
BPW	05362706500	EFR7302	BPW	0936272112	EFR7950
BPW	0536270652	EFR7302	BPW	0936272120	EFR7951
BPW	0536270653	EFR7302	BPW	0936272121	EFR7951
BPW	05362706530	EFR7302	BPW	0936272122	EFR7951
BPW	0536270660	EFR6301	BPW	0936272130	EFR6950
BPW	0536270670	EFR6300	BPW	0936272131	EFR6950
BPW	0536270680	EFR7303	BPW	0936272140	EFR6951
BPW	0536270681	EFR7303	BPW	0936272141	EFR6951
BPW	0536270690	EFR7302	BPW	0936272150	EFR7952
BPW	0536270691	EFR7302	BPW	0936272152	EFR7952
BPW	0536270700	EFR6309	BPW	0936272160	EFR7953
BPW	0536270701	EFR6309	BPW	0936272200	EFR6953
BPW	0536270710	EFR6308	BPW	0936272203	EFR6953
BPW	0536270711	EFR6308	BPW	0936272210	EFR6952
BPW	0536270790	EFR5302	BPW	0936272213	EFR6952
BPW	0536270800	EFR5303	BPW	0936272220	EFR7955
BPW	0536270810	EFR6308	BPW	0936272223	EFR7955
BPW	0536270820	EFR6309	BPW	0936272230	EFR7954
BPW	0536272010	EFR7950	BPW	0936272233	EFR7954
BPW	0536272020	EFR7951	BPW	0936272660	EFR7953
BPW	0536272030	EFR6950	BPW	0939272150	EFR7952
BPW	0536272040	EFR6951	BPW	0980102200	2920200604
BPW	0536272050	EFR7952	BPW	0980102200	2927801
BPW	0536272060	EFR7953	BPW	0980102570	2920200604
BPW	0536272200	EFR6953	BPW	0980102570	2927801
BPW	0536272210	EFR6952	BPW	0980102570	2930701
BPW	0536272220	EFR7955	BPW	0980102570	CVP093K
BPW	0536272230	EFR7954	BPW	0980102610	CAC005
BPW	0900061790	2922701	BPW	0980102630	CAC008
BPW	0900061793	29267xx	BPW	0980102670	EFR7302
BPW	0908835120	09.B072.10	BPW	0980102680	EFR7303
BPW	0908835120	93127100	BPW	0980102690	EFR7303
BPW	0908835120	FCR222A	BPW	0980102700	EFR7302
BPW	0908835127	09.B072.10	BPW	0980102750	2930601
BPW	0908835127	93127100	BPW	09801028700	CAC005
BPW	0908835127	FCR222A	BPW	0980102880	CAC005
BPW	0936272010	EFR7950	BPW	0980102920	2920200604
BPW	0936272011	EFR7950	BPW	0980102920	2925305390

Les correspondances de références ont pour seul objectif d'aider la recherche de référence

Cross references are there for the sole purpose of helping the reference search

CORRESPONDANCES DES REFERENCES CROSS REFERENCE LIST

MARQUE/MAKER	REF/PN OES	REF/PN	MARQUE/MAKER	REF/PN OES	REF/PN
BPW	0980102920	2927801	BPW	0980107960	2922800604
BPW	0980102920	2930701	BPW	0980107960	2922801
BPW	0980102920	CVP020K	BPW	0980107971	2922800604
BPW	0980102920	CVP093K	BPW	0980107971	2922801
BPW	0980102930	2930601	BPW	0980107980	29267xx
BPW	0980102930	2932004	BPW	0980108150	2930601
BPW	0980106200	2920200604	BPW	0980108151	2930601
BPW	0980106200	2925305390	BPW	0980108160	2930801
BPW	0980106200	2927801	BPW	0980108160	CVP094K
BPW	0980106200	2930701	BPW	0980108161	2930801
BPW	0980106200	CVP020K	BPW	0980108161	CVP094K
BPW	0980106200	CVP093K	BPW	0980108170	2930701
BPW	0980106210	2930601	BPW	0980108170	CVP093K
BPW	0980106240	CAC024	BPW	0980108171	2930701
BPW	0980106310	CAC010	BPW	0980108171	CVP093K
BPW	0980106310	CAC042	BPW	0980108370	2922701
BPW	0980106320	CAC009	BPW	0980108720	2940501
BPW	0980106330	CAC007	BPW	0980108730	2940301
BPW	0980106350	2930601	BPW	0980166320	CAC009
BPW	0980106360	2920200604	BPW	980102930	CVP036K
BPW	0980106360	2927801	CATERPILLAR	2799440	CAC016
BPW	0980106360	2930701	DAF	0299095	93084000
BPW	0980106360	CVP093K	DAF	0299095	FCR100A
BPW	0980106430	2930601	DAF	0906252R	EFR7704
BPW	0980106440	2930801	DAF	0906253R	EFR7705
BPW	0980106440	CVP094K	DAF	1137179	09.B325.40
BPW	0980106450	2930701	DAF	1137179	93086800
BPW	0980106450	CVP093K	DAF	1137179	FCR168A
BPW	0980106950	2930801	DAF	1142086	93187600
BPW	0980106950	CVP094K	DAF	1142131	EFR6301
BPW	0980106960	2930701	DAF	1142133	EFR6300
BPW	0980106960	CVP093K	DAF	1142142	CAC005
BPW	0980107070	2918302	DAF	1152369	CAC007
BPW	0980107090	2930601	DAF	1154212	EFR6301
BPW	0980107240	2930601	DAF	1154213	EFR6300
BPW	0980107250	2930701	DAF	1198153	CAC005
BPW	0980107250	CVP093K	DAF	1198154	CAC005
BPW	0980107260	2930801	DAF	1238372	93084000
BPW	0980107260	CVP094K	DAF	1238372	FCR100A
BPW	0980107261	2930801	DAF	13162045	09.9354.10
BPW	0980107261	CVP094K	DAF	13162045	93142700
BPW	0980107280	2930701	DAF	13162045	FCR257A
BPW	0980107280	CVP093K	DAF	1364759	EFR7303
BPW	0980107550	2922701	DAF	1364760	EFR7302
BPW	0980107570	2922800604	DAF	1366012	EFR7311
BPW	0980107570	2922801	DAF	1366013	EFR7310
BPW	0980107590	29267xx	DAF	1366014	EFR7311
BPW	0980107940	2922701	DAF	1366015	EFR7310

Les correspondances de références ont pour seul objectif d'aider la recherche de référence

Cross references are there for the sole purpose of helping the reference search

CORRESPONDANCES DES REFERENCES CROSS REFERENCE LIST

MARQUE/MAKER	REF/PN OES	REF/PN	MARQUE/MAKER	REF/PN OES	REF/PN
DAF	1387439	93145600	DAF	1436853	CAC017
DAF	1387439	DF70004+	DAF	1436901	2928502
DAF	1387439	FCR225A	DAF	1436901	CVP032K
DAF	1387446	EFR7309	DAF	1436901	W0330DA1
DAF	1387447	EFR7308	DAF	1439324	2920200604
DAF	1388273	EFR7303	DAF	1439324	2925305390
DAF	1388274	EFR7302	DAF	1439324	2927801
DAF	1391987	EFR7302	DAF	1439324	2927802
DAF	1391988	EFR7303	DAF	1439324	2927804
DAF	1393558	EFR7311	DAF	1439324	CVP020K
DAF	1393559	EFR7310	DAF	1440500	EFR5002
DAF	1399063	EFR7309	DAF	1440501	EFR5003
DAF	1399064	EFR7308	DAF	1440504	FCV1389
DAF	1400069	09.9354.10	DAF	1440505	CAC018
DAF	1400069	93142700	DAF	1448913	CAC008
DAF	1400069	FCR257A	DAF	1448915	CAC005
DAF	1400163	09.9361.10	DAF	1449167	EFR7309
DAF	1400163	09.E664.20	DAF	1449167R	EFR7309
DAF	1400163	93187700	DAF	1449168	EFR7308
DAF	1400163	FCR350A	DAF	1449168R	EFR7308
DAF	1400273	93187800	DAF	1453988	EFR7309
DAF	1400273	FCR226A	DAF	1453989	EFR7308
DAF	1400284	09.E452.20	DAF	1489989	CAC016
DAF	1400284	93142800	DAF	1505372	EFR5006
DAF	1400284	FCR258A	DAF	1505372R	EFR5006
DAF	1403632	EFR5002	DAF	1505373	EFR5007
DAF	1403633	EFR5003	DAF	1505373R	EFR5007
DAF	1403758	93142500	DAF	1505381	2905503
DAF	1403758	FCR256A	DAF	1505382	2928502
DAF	1407581	93187800	DAF	1505382	CVP032K
DAF	1407581	FCR226A	DAF	1517298	2905503
DAF	1407634	EFR6004	DAF	1517391	W0295MA1
DAF	1407635	EFR6005	DAF	1517392	2928502
DAF	1408252	09.9361.10	DAF	1517392	CVP032K
DAF	1408252	09.E664.20	DAF	1519146	2928502
DAF	1408252	93187700	DAF	1519146	CVP032K
DAF	1408252	FCR350A	DAF	1521148	09.B325.40
DAF	1408253	93142500	DAF	1521148	93086800
DAF	1408253	FCR256A	DAF	1521148	FCR168A
DAF	1408254	93187800	DAF	1521324	CAC007
DAF	1408254	FCR226A	DAF	1522067	EFR7658
DAF	1408670	09.E664.20	DAF	1522067R	EFR7658
DAF	1408670	93187700	DAF	1522068	EFR7659
DAF	1408670	FCR350A	DAF	1522068R	EFR7659
DAF	1408671	93142500	DAF	1522093	EFR5002
DAF	1408671	FCR256A	DAF	1522093R	EFR5002
DAF	1408672	93187800	DAF	1522094	EFR5003
DAF	1408672	FCR226A	DAF	1522094R	EFR5003

Les correspondances de références ont pour seul objectif d'aider la recherche de référence

Cross references are there for the sole purpose of helping the reference search

CORRESPONDANCES DES REFERENCES CROSS REFERENCE LIST

MARQUE/MAKER	REF/PN OES	REF/PN	MARQUE/MAKER	REF/PN OES	REF/PN
DAF	1522111	EFR5000	DAF	1640561	FCR225A
DAF	1522111R	EFR5000	DAF	1658010	EFR7328
DAF	1522112	EFR5001	DAF	1658010R	EFR7328
DAF	1522112R	EFR5001	DAF	1658011	EFR7329
DAF	1522113R	EFR6002	DAF	1658011R	EFR7329
DAF	1522114R	EFR6003	DAF	1658012	EFR7308
DAF	1524612	EFR7660	DAF	1658012R	EFR7308
DAF	1524613	EFR7661	DAF	1658013	EFR7309
DAF	1525365	09.B325.40	DAF	1658013R	EFR7309
DAF	1525365	93086800	DAF	1689313	CAC009
DAF	1525365	FCR168A	DAF	1690420	CAC008
DAF	1527854	CAC026	DAF	1703801	93322400
DAF	1542600	93145600	DAF	1703801	FCR376A
DAF	1542600	DF70004+	DAF	1703805	93322400
DAF	1542600	FCR225A	DAF	1703805	FCR376A
DAF	1612740	EFR7308	DAF	1709060	DF713891
DAF	1612741	EFR7309	DAF	1716712	09.E452.20
DAF	1617343	2920200604	DAF	1716712	93142800
DAF	1617343	2925305390	DAF	1716712	FCR258A
DAF	1617343	2927801	DAF	1726138	93145600
DAF	1617343	2927802	DAF	1726138	DF70004+
DAF	1617343	2927804	DAF	1726138	FCR225A
DAF	1617343	CVP020K	DAF	1739542	93145600
DAF	1622785	CAC009	DAF	1739542	DF70004+
DAF	1622786	CAC007	DAF	1739542	FCR225A
DAF	1622786	CAC042	DAF	1783346	93145600
DAF	1623221	CAC008	DAF	1783346	DF70004+
DAF	1627240	EFR7308	DAF	1783346	FCR225A
DAF	1627241	EFR7309	DAF	1797053	2920200604
DAF	1627244	EFR7308	DAF	1797053	2925305390
DAF	1627244R	EFR7308	DAF	1797053	2927801
DAF	1627245	EFR7309	DAF	1797053	2927802
DAF	1627245R	EFR7309	DAF	1797053	2927804
DAF	1627246	EFR7308	DAF	1797053	CVP020K
DAF	1627246R	EFR7308	DAF	1800830	2920200604
DAF	1627247	EFR7309	DAF	1800830	2927802
DAF	1627247R	EFR7309	DAF	1800830	2927804
DAF	1628062	EFR6004	DAF	1800830	CVP020K
DAF	1628063	EFR6005	DAF	1812563	93145600
DAF	1628064	2931301	DAF	1812563	DF70004+
DAF	1628065	CAC019	DAF	1812563	FCR225A
DAF	1639100	CAC007	DAF	1812582	93145600
DAF	1639100	CAC042	DAF	1812582	DF70004+
DAF	1640560	93145600	DAF	1812582	FCR225A
DAF	1640560	DF70004+	DAF	1847716	CAC025
DAF	1640560	FCR225A	DAF	1857920	EFR7328
DAF	1640561	93145600	DAF	1857920R	EFR7328
DAF	1640561	DF70004+	DAF	1857921	EFR7329

Les correspondances de références ont pour seul objectif d'aider la recherche de référence

Cross references are there for the sole purpose of helping the reference search

CORRESPONDANCES DES REFERENCES CROSS REFERENCE LIST

MARQUE/MAKER	REF/PN OES	REF/PN	MARQUE/MAKER	REF/PN OES	REF/PN
DAF	1857921R	EFR7329	DAF	829700	EFR7303
DAF	1862290	EFR7302	DAF	829763	EFR7302
DAF	1862290R	EFR7328	DAF	829764	EFR7303
DAF	1862291	EFR7303	DAF	829771	EFR6300
DAF	1862291R	EFR7329	DAF	829772	EFR6301
DAF	1862300	EFR7302	DAF	866216	EFR6006
DAF	1862301	EFR7303	DAF	866217	EFR6007
DAF	1878030	2920200604	DAF	960801	W0330DA1
DAF	1878030	2925305390	DAF	AMPA014	93105700
DAF	1878030	2927801	DAF	AMPA014	FCR151A
DAF	1878030	2927802	DAF	AMPA048	EFR5004
DAF	1878030	2927804	DAF	AMPA049	EFR5005
DAF	1878030	CVP020K	DAF	AMPA694	2907702
DAF	1962265	2920200604	DAF	AMPB005	EFR5004
DAF	1962265	2925305390	DAF	AMPB006	EFR5005
DAF	1962265	2927802	DAF	AMPB016	2907702
DAF	1962265	2927804	DAF	AMPB481	93105700
DAF	1962265	CVP020K	DAF	AMPB481	FCR151A
DAF	1962280	09.B325.40	DAF	AMPB860	93105700
DAF	1962280	93086800	DAF	AMPB860	FCR151A
DAF	1962280	FCR168A	DAF	BBU8177	2907702
DAF	1962326	09.E166.10	DAF	NJK2785	93105700
DAF	1962326	FCR347A	DAF	NJK2785	FCR151A
DAF	1978630	EFR7308	DAF	NJK3571	09.9354.10
DAF	1978631	EFR7309	DAF	NJK3571	93142700
DAF	1978632	EFR7302	DAF	NJK3571	FCR257A
DAF	1978633	EFR7303	DAF	TP08012002	EFR5005
DAF	1978635	EFR7328	DAF	TP08012003	EFR5004
DAF	1978636	EFR7329	DANA	828105	EFR7300
DAF	1978636A	EFR7329	DANA	828106	EFR7301
DAF	1982826	2920200604	DANA	828120	EFR7302
DAF	1982826	2925305390	DANA	828121	EFR7303
DAF	1982826	2927802	DANA	829688	EFR7696
DAF	1982826	2927804	DANA	829689	EFR7697
DAF	1982826	CVP020K	DANA	829697	EFR7696
DAF	2012160	2928502	DANA	829698	EFR7697
DAF	2012160	CVP032K	DANA	829757	EFR7696
DAF	2012161	2931301	DANA	829758	EFR7697
DAF	2112768	2920200604	DANA	829765	EFR7718
DAF	2112768	2927804	DANA	829766	EFR7718
DAF	2112768	CVP020K	DANA	829766	EFR7719
DAF	221412	93084000	DANA	829785	EFR7303
DAF	221412	FCR100A	DANA	829786	EFR7302
DAF	68323004	98028600	DANA	829788	EFR7305
DAF	68323004	W0380DA1	DANA	829789	EFR7304
DAF	829691	EFR6300	DANA	A829691	EFR6300
DAF	829692	EFR6301	DANA	A829692	EFR6301
DAF	829699	EFR7302	DANA	SL486/47	EFR6308

Les correspondances de références ont pour seul objectif d'aider la recherche de référence

Cross references are there for the sole purpose of helping the reference search

CORRESPONDANCES DES REFERENCES CROSS REFERENCE LIST

MARQUE/MAKER	REF/PN OES	REF/PN	MARQUE/MAKER	REF/PN OES	REF/PN
DANA	SL486/48	EFR6309	DANA	SM48617K	EFR7303
DANA	SL48647	EFR6308	DANA	SM48618K	EFR7302
DANA	SL48648	EFR6309	DANA	SM48619K	EFR7303
DANA	SM45324K	EFR7614	DANA	SM48625K	EFR6300
DANA	SM45325K	EFR7615	DANA	SM48626K	EFR6301
DANA	SM45328K	EFR7612	DANA	SM48627K	EFR6301
DANA	SM45329K	EFR7613	DANA	SM48628K	EFR6300
DANA	SM45330K	EFR7614	DANA	SM4862K	EFR7302
DANA	SM45331K	EFR7615	DANA	SM48631K	EFR7302
DANA	SM45332K	EFR7614	DANA	SM48632K	EFR7303
DANA	SM45333K	EFR7615	DANA	SM48633K	EFR6300
DANA	SM486/10K	EFR7302	DANA	SM48634K	EFR6301
DANA	SM486/11K	EFR7303	DANA	SM48635K	EFR7302
DANA	SM486/12K	EFR7302	DANA	SM48636K	EFR7303
DANA	SM486/13K	EFR7303	DANA	SM48637K	EFR7302
DANA	SM486/14K	EFR7302	DANA	SM48638K	EFR7303
DANA	SM486/15K	EFR7303	DANA	SM4863K	EFR7303
DANA	SM486/16K	EFR7302	DANA	SM48641K	EFR7302
DANA	SM486/17K	EFR7303	DANA	SM48642K	EFR7303
DANA	SM486/18K	EFR7302	DANA	SM48643K	EFR7302
DANA	SM486/19K	EFR7303	DANA	SM48644K	EFR7303
DANA	SM486/27K	EFR6301	DANA	SM48645K	EFR6308
DANA	SM486/28K	EFR6300	DANA	SM48646K	EFR6309
DANA	SM486/33K	EFR6300	DANA	SM48647K	EFR6308
DANA	SM486/34K	EFR6301	DANA	SM48648K	EFR6309
DANA	SM486/35K	EFR7302	DANA	SM48649K	EFR7302
DANA	SM486/36K	EFR7303	DANA	SM4864K	EFR7302
DANA	SM486/37K	EFR7302	DANA	SM48650K	EFR7303
DANA	SM486/38K	EFR7303	DANA	SM48651K	EFR7302
DANA	SM486/41K	EFR7302	DANA	SM48652K	EFR7303
DANA	SM486/42K	EFR7303	DANA	SM48653K	EFR7302
DANA	SM486/43K	EFR7302	DANA	SM48654K	EFR7303
DANA	SM486/44K	EFR7303	DANA	SM48655K	EFR7314
DANA	SM486/45K	EFR6308	DANA	SM48656K	EFR7315
DANA	SM486/46K	EFR6309	DANA	SM4865K	EFR7303
DANA	SM486/47K	EFR6308	DANA	SM4866K	EFR7302
DANA	SM486/48K	EFR6309	DANA	SM4867K	EFR7303
DANA	SM486/6K	EFR7302	DANA	SM4868K	EFR7302
DANA	SM486/7K	EFR7303	DANA	SM4869K	EFR7303
DANA	SM486/8K	EFR7302	DANA	SM487/42K	CAC005
DANA	SM486/9K	EFR7303	DANA	SM487/44K	CAC008
DANA	SM48610K	EFR7302	DEMAG	82586740	EFR5006
DANA	SM48611K	EFR7303	DEMAG	82586840	EFR5007
DANA	SM48612K	EFR7302	DENNIS	653563	EFR7710
DANA	SM48613K	EFR7303	DENNIS	653564	EFR7711
DANA	SM48614K	EFR7302	DENNIS	655079	EFR7606
DANA	SM48615K	EFR7303	DENNIS	655080	EFR7607
DANA	SM48616K	EFR7302	DENNIS	655377	EFR7612

Les correspondances de références ont pour seul objectif d'aider la recherche de référence

Cross references are there for the sole purpose of helping the reference search

CORRESPONDANCES DES REFERENCES CROSS REFERENCE LIST

MARQUE/MAKER	REF/PN OES	REF/PN	MARQUE/MAKER	REF/PN OES	REF/PN
DENNIS	6553773	EFR7612	DENNIS	66042625	EFR7314
DENNIS	6553774	EFR7613	ERF	35403112182	CAC011
DENNIS	655378	EFR7613	ERF	35403112205	CAC012
DENNIS	657126	09.B325.40	ERF	35403113040	CAC005
DENNIS	657126	93086800	ERF	35404210822	EFR7301
DENNIS	657126	FCR168A	ERF	35404210839	EFR7300
DENNIS	657303	09.B325.40	ERF	35404210845	EFR7309
DENNIS	657303	93086800	ERF	35404210851	EFR7308
DENNIS	657303	FCR168A	ERF	35503075416	EFR7716
DENNIS	65733410	EFR7314	ERF	35503075422	EFR7717
DENNIS	65733411	EFR7315	ERF	35503084911	EFR6305
DENNIS	65847039	09.B325.40	ERF	35503084911R	EFR6305
DENNIS	65847039	93086800	ERF	35503084928	EFR6304
DENNIS	65847039	FCR168A	ERF	35503084928R	EFR6304
DENNIS	65847042	EFR7303	ERF	35503086447	CAC008
DENNIS	65847043	EFR7302	ERF	35503092569	EFR7694
DENNIS	65847045	EFR7303	ERF	35503092575	EFR7695
DENNIS	65847046	EFR7302	ERF	35503109554	EFR7636
DENNIS	658517	09.B325.40	ERF	35503109560	EFR7637
DENNIS	658517	93086800	ERF	35503120460	EFR7716
DENNIS	658517	FCR168A	ERF	35503120460	EFR7717
DENNIS	65851723	EFR7314	ERF	35503120477	EFR7717
DENNIS	65851724	EFR7315	ERF	35504171466	EFR7695
DENNIS	658517-29	CAC010	ERF	35504171472	EFR7694
DENNIS	65851733	EFR7314	ERF	35504208392	EFR7695
DENNIS	65851734	EFR7315	ERF	35504208400	EFR7694
DENNIS	65851735	EFR7314	EVOBUS	0004200782	CAC005
DENNIS	65851736	EFR7315	EVOBUS	0004214310	2920200604
DENNIS	658537	09.B325.40	EVOBUS	0004214310	2927801
DENNIS	658537	93086800	EVOBUS	0014200701	EFR7300
DENNIS	658537	FCR168A	EVOBUS	0014200801	EFR7301
DENNIS	6593321	EFR7302	EVOBUS	0024207183	EFR7312
DENNIS	6593322	EFR7303	EVOBUS	0024207283	EFR7313
DENNIS	659334-2	CAC024	EVOBUS	0024208183	EFR7304
DENNIS	65938709	EFR7303	EVOBUS	0024208283	EFR7305
DENNIS	65938710	EFR7302	EVOBUS	0044203583	EFR7343
DENNIS	65938712	EFR7302	EVOBUS	0044203683	EFR7342
DENNIS	65968711	EFR7303	EVOBUS	0044208783	EFR7304
DENNIS	6597421	2931303	EVOBUS	0044208883	EFR7305
DENNIS	6597422	CAC019	EVOBUS	0064201020	2920200604
DENNIS	65992124	EFR7314	EVOBUS	0064201020	2927801
DENNIS	65992125	EFR7315	EVOBUS	179241111131	09.8128.10
DENNIS	6601961	EFR7302	EVOBUS	179241111131	93067600
DENNIS	6601962	EFR7303	EVOBUS	179241111131	FCR113A
DENNIS	66036409	EFR7302	EVOBUS	1792411111310	09.8128.10
DENNIS	66036410	EFR7303	EVOBUS	1792411111310	93067600
DENNIS	6603644	CAC007	EVOBUS	1792411111310	FCR113A
DENNIS	66042624	EFR7315	EVOBUS	179241111131B	09.8128.10

Les correspondances de références ont pour seul objectif d'aider la recherche de référence

Cross references are there for the sole purpose of helping the reference search

CORRESPONDANCES DES REFERENCES CROSS REFERENCE LIST

MARQUE/MAKER	REF/PN OES	REF/PN	MARQUE/MAKER	REF/PN OES	REF/PN
EVOBUS	179241111131B	93067600	EVOBUS	8285390000	93058100
EVOBUS	179241111131B	FCR113A	EVOBUS	8285390000	FCR114A
EVOBUS	2069432001	09.8129.20	EVOBUS	8285408000A	EFR7606
EVOBUS	2069432001	93058100	EVOBUS	8285408463	2903009
EVOBUS	2069432001	FCR114A	EVOBUS	8285408463	CVP013K
EVOBUS	501005573	EFR7306	EVOBUS	82854084630	2908302
EVOBUS	501005574	EFR7307	EVOBUS	82854084630	CVP013K
EVOBUS	501006007	EFR7316	EVOBUS	8285408464	2905301
EVOBUS	501006008	EFR7317	EVOBUS	82854084640	2905301
EVOBUS	501006016	EFR7303	EVOBUS	8285408534	2903009
EVOBUS	501006017	EFR7302	EVOBUS	8285408534	CVP013K
EVOBUS	501006195	EFR7314	EVOBUS	82854085340	2903009
EVOBUS	501006196	EFR7315	EVOBUS	82854085340	CVP013K
EVOBUS	501006293	EFR7304	EVOBUS	8285409000A	EFR7607
EVOBUS	501006294	EFR7305	EVOBUS	8285441000A	EFR7606
EVOBUS	501006320	EFR7304	EVOBUS	8285442000A	EFR7607
EVOBUS	501006321	EFR7305	EVOBUS	8285443000A	EFR7606
EVOBUS	501006591	EFR7314	EVOBUS	8285444000A	EFR7607
EVOBUS	501006592	EFR7315	EVOBUS	8285472000	93101200
EVOBUS	501006599	EFR7316	EVOBUS	8285515573	2920200604
EVOBUS	501006600	EFR7317	EVOBUS	8285515573	2925305390
EVOBUS	501006850	EFR7316	EVOBUS	8285515573	2927801
EVOBUS	501006851	EFR7317	EVOBUS	8285515573	2927802
EVOBUS	501007172	EFR7316	EVOBUS	8285515573	CVP020K
EVOBUS	501007173	EFR7317	EVOBUS	8285515623	EFR7301
EVOBUS	501313313	09.8129.20	EVOBUS	8285515624	EFR7300
EVOBUS	501313313	93058100	EVOBUS	8285521000	2903009
EVOBUS	501313313	FCR114A	EVOBUS	8285521000	CVP013K
EVOBUS	6664300099	EFR7310	EVOBUS	8285522000	2903009
EVOBUS	6664300199	EFR7311	EVOBUS	8285522000	CVP013K
EVOBUS	68320504NGZ	CVP013K	EVOBUS	8285525000	2903005392
EVOBUS	68320820	09.8129.20	EVOBUS	8285525000	2903009
EVOBUS	68320820	93058100	EVOBUS	8285525000	CVP013K
EVOBUS	68320820	FCR114A	EVOBUS	8285526000	2903005392
EVOBUS	82823884510	98017600	EVOBUS	8285526000	2903009
EVOBUS	82850005890	93101200	EVOBUS	8285526000	CVP013K
EVOBUS	82853554510	98017600	EVOBUS	8285543000	93101200
EVOBUS	8285388435	2903009	EVOBUS	8919800519	EFR7314
EVOBUS	8285388435	CVP013K	EVOBUS	89198005190	EFR7314
EVOBUS	8285388436	2905301	EVOBUS	8919800520	EFR7315
EVOBUS	82853884510	98017600	EVOBUS	89198005200	EFR7315
EVOBUS	8285388529	EFR7606	EVOBUS	8919800521	EFR7316
EVOBUS	8285388533	2903009	EVOBUS	8919800522	EFR7317
EVOBUS	8285388533	CVP013K	EVOBUS	89199370224	EFR7306
EVOBUS	8285388535	2905301	EVOBUS	924111113	09.8128.10
EVOBUS	82853888	EFR7606	EVOBUS	924111113	93067600
EVOBUS	82853889	EFR7607	EVOBUS	924111113	FCR113A
EVOBUS	8285390000	09.8129.20	EVOBUS	A0004200782	CAC005

Les correspondances de références ont pour seul objectif d'aider la recherche de référence

Cross references are there for the sole purpose of helping the reference search

CORRESPONDANCES DES REFERENCES CROSS REFERENCE LIST

MARQUE/MAKER	REF/PN OES	REF/PN	MARQUE/MAKER	REF/PN OES	REF/PN
EVOBUS	A0004201502	EFR7316	EVOBUS	A6664300090	EFR7310
EVOBUS	A0004201602	EFR7317	EVOBUS	A6664300099	EFR7310
EVOBUS	A0004214310	2920200604	EVOBUS	A6664300190	EFR7311
EVOBUS	A0004214310	2927801	EVOBUS	A6664300199	EFR7311
EVOBUS	A0024207183	EFR7312	EVOBUS	Q8285515000	EFR7301
EVOBUS	A0024207283	EFR7313	EVOBUS	Q8285516000	EFR7300
EVOBUS	A0034200083	EFR7302	EVOBUS	Q8285543000	93101200
EVOBUS	A0034200383	EFR7303	FAW	3501025A4S	EFR7002
EVOBUS	A0044203583	EFR7343	FAW	3501030A4S	EFR7003
EVOBUS	A0044203683	EFR7342	FERODO	FAI101	98022800
EVOBUS	A0044205983	EFR7310	FERODO	FAI101	W0365RT
EVOBUS	A0044206083	EFR7311	FERODO	FAI105	W0250IV
EVOBUS	A0044208783	EFR7304	FERODO	FAI107	98017200
EVOBUS	A0044208883	EFR7305	FERODO	FAI108	98017600
EVOBUS	A0044208983	EFR7343	FERODO	FAI110	98022400
EVOBUS	A0044209083	EFR7342	FERODO	FAI110	W0400IV
EVOBUS	A0054201183	EFR7316	FERODO	FAI111	98028700
EVOBUS	A0054201283	EFR7317	FERODO	FAI113	98028400
EVOBUS	A0054202183	EFR6306	FERODO	FAI116	98025200
EVOBUS	A0054202283	EFR6307	FERODO	FAI117	98031900
EVOBUS	A0054202383	EFR7310	FERODO	FAI117	W0400RT
EVOBUS	A0054202483	EFR7311	FERODO	FAI119	98025000
EVOBUS	A0054203183	EFR7312	FERODO	FAI125	98025300
EVOBUS	A0054203283	EFR7313	FERODO	FAI125	W0310IV34
EVOBUS	A0054203383	EFR7314	FERODO	FAI126	98031500
EVOBUS	A0054203483	EFR7315	FERODO	FAI126	W0365IV1
EVOBUS	A0064201020	2920200604	FERODO	FAI130	98032300
EVOBUS	A0064201020	2920200604	FERODO	FAI132	98032000
EVOBUS	A0064201020	2927801	FERODO	FAI141	98025400
EVOBUS	A0064201020	2927802	FERODO	FAI150	W0295MA1
EVOBUS	A0064201020	CVP020K	FERODO	FAI151	98024100
EVOBUS	A0084206020	2920200604	FERODO	FAI152	98031600
EVOBUS	A0084206020	2927802	FERODO	FAI152	W0330DA1
EVOBUS	A0084206020	CVP020K	FERODO	FAI160	98025300
EVOBUS	A179241111131	09.8128.10	FERODO	FAI160	W0310IV34
EVOBUS	A179241111131	93067600	FERODO	FAI161	98024300
EVOBUS	A179241111131	FCR113A	FERODO	FAI162	98024300
EVOBUS	A3564202901	EFR7609	FERODO	FAI163	98027600
EVOBUS	A4444200201	EFR6306	FERODO	FAI163	W0355RT1V1
EVOBUS	A4444200301	EFR6307	FERODO	FAI164	98032400
EVOBUS	A4444200401	EFR6306	FERODO	FAI164	W0290MA1
EVOBUS	A4444200501	EFR6307	FERODO	FAI165	98041100
EVOBUS	A6284200701	EFR7304	FERODO	FAI166	98027500
EVOBUS	A6284200801	EFR7305	FERODO	FAI166	W0450RT1
EVOBUS	A6284200901	EFR7304	FERODO	FAI168	98028600
EVOBUS	A6284201001	EFR7305	FERODO	FAI168	W0380DA1
EVOBUS	A62942009020005	EFR7343	FERODO	FAI169	98028200
EVOBUS	A62942010020005	EFR7342	FERODO	FAI169	W0355RT1V2

Les correspondances de références ont pour seul objectif d'aider la recherche de référence

Cross references are there for the sole purpose of helping the reference search

CORRESPONDANCES DES REFERENCES CROSS REFERENCE LIST

MARQUE/MAKER	REF/PN OES	REF/PN	MARQUE/MAKER	REF/PN OES	REF/PN
FERODO	FAI169	WIK538	FERODO	FCV1136	2910004
FERODO	FAI171	98028800	FERODO	FCV1159B	2910004
FERODO	FAI171	W0360SA	FERODO	FCV1275BFE	2936101
FERODO	FAI172	98028900	FERODO	FCV1275BFE	CVP036K
FERODO	FAI172	W0760BP	FERODO	FCV1277BFE	2918302
FERODO	FAI172	W0940SABP	FERODO	FCV1279	2928503
FERODO	FAI173	98025300	FERODO	FCV1279	CVP032K
FERODO	FAI173	W0310IV34	FERODO	FCV1329BFE	2936101
FERODO	FAI178	W0760SA	FERODO	FCV1329BFE	CVP036K
FERODO	FAI181	W0610SA	FERODO	FCV1354	2928503
FERODO	FAI186	W0335RT1	FERODO	FCV1354	CVP032K
FERODO	FAI200	98016800	FERODO	FCV1366	29154xx
FERODO	FAI201	98016900	FERODO	FCV1367B	2914302
FERODO	FAI202	98017000	FERODO	FCV1373BFE	2920200604
FERODO	FAI203	98017100	FERODO	FCV1373BFE	2927802
FERODO	FAI205	98023500	FERODO	FCV1373BFE	CVP020K
FERODO	FAI206	98023600	FERODO	FCV1373BHD	2920200604
FERODO	FAI207	98032200	FERODO	FCV1373BHD	2927802
FERODO	FAI208	98032100	FERODO	FCV1373BHD	CVP020K
FERODO	FCR132A	09.6739.20	FERODO	FCV1373DFE	CVP020K
FERODO	FCR142A	09.9746.10	FERODO	FCV1386B	2913606
FERODO	FCR149A	09.7873.10	FERODO	FCV1387B	2913706
FERODO	FCR170A	09.A995.10	FERODO	FCV1388B	2927705
FERODO	FCR170A	DF70003	FERODO	FCV1388B	CVP037K
FERODO	FCR180A	09.7286.10	FERODO	FCV1389	29142xx
FERODO	FCR186A	09.8574.10	FERODO	FCV1404BFE	2913105
FERODO	FCR187A	09.9181.10	FERODO	FCV1404BFE	CVP088K
FERODO	FCR188A	09.9182.10	FERODO	FCV1578BFE	2903007
FERODO	FCR190A	09.8925.10	FERODO	FCV1578BFE	CVP013K
FERODO	FCR192A	09.9396.10	FERODO	FCV1579BFE	2911303
FERODO	FCR201A	09.8793.10	FERODO	FCV1583B	2905301
FERODO	FCR215A	DF70002	FERODO	FCV1584B	2911401
FERODO	FCR219A	09.9493.60	FERODO	FCV1585BFE	2903007
FERODO	FCR255A	09.9361.10	FERODO	FCV1585BFE	CVP013K
FERODO	FCR257A	09.9354.10	FERODO	FCV1598BFE	2920200604
FERODO	FCR306A	09.9745.10	FERODO	FCV1598BFE	2927802
FERODO	FCR308A	09.A563.80	FERODO	FCV1598BFE	CVP020K
FERODO	FCR318A	09.9983.60	FERODO	FCV1614	2907503
FERODO	FCR319A	09.A562.10	FERODO	FCV1614	2918602
FERODO	FCR324A	09.9494.40	FERODO	FCV1624B	2917705
FERODO	FCR337A	08.8383.10	FERODO	FCV1624B	CVP095K
FERODO	FCR338A	09.A315.10	FERODO	FCV1653BFE	2913105
FERODO	FCR342A	09.A315.60	FERODO	FCV1653BFE	CVP088K
FERODO	FCR374A	09.9497.10	FERODO	FCV1656BFE	2913103
FERODO	FCV1042	2907702	FERODO	FCV1656BFE	CVP088K
FERODO	FCV1047B	2909006	FERODO	FCV1657B	2926900604
FERODO	FCV1047B	CVP023K	FERODO	FCV1657B	2926901
FERODO	FCV1086B	2908402	FERODO	FCV1677B	2930701

Les correspondances de références ont pour seul objectif d'aider la recherche de référence

Cross references are there for the sole purpose of helping the reference search

CORRESPONDANCES DES REFERENCES CROSS REFERENCE LIST

MARQUE/MAKER	REF/PN OES	REF/PN	MARQUE/MAKER	REF/PN OES	REF/PN
FERODO	FCV1677B	CVP093K	FERODO	FCV4345PTS	2927802
FERODO	FCV1678B	2930601	FERODO	FCV4345PTS	CVP020K
FERODO	FCV1762BFE	2903009	FERODO	FCV4352B	29180xx
FERODO	FCV1762BFE	CVP013K	FERODO	FCV4374BFE	2920200604
FERODO	FCV1763B	2905301	FERODO	FCV4374BFE	2927802
FERODO	FCV1792BFE	2932005	FERODO	FCV4374BFE	CVP020K
FERODO	FCV1792BFE	CVP036K	FERODO	FCV4377B	2917300604
FERODO	FCV1813	2909006	FERODO	FCV4377B	2917301
FERODO	FCV1813	CVP023K	FERODO	FCV4377B	CVP100K
FERODO	FCV1813B	2909006	FERODO	FCV4378BFE	2917400604
FERODO	FCV1813B	CVP023K	FERODO	FCV4378BFE	2917401
FERODO	FCV1814BFE	FCV4420B	FERODO	FCV4378BFE	CVP101K
FERODO	FCV1815BFE	2918100604	FERODO	FCV4417PTS	2924601
FERODO	FCV1815BFE	2918101	FERODO	FCV4418PTS	2924401
FERODO	FCV1821B	2915001	FERODO	FCV4419	2927900604
FERODO	FCV1825B	2930801	FERODO	FCV4419	2927901
FERODO	FCV1825B	CVP094K	FERODO	FCV4461BFE	2926900604
FERODO	FCV1828	2933601	FERODO	FCV4461BFE	2926901
FERODO	FCV1857BFE	2912405	FERODO	FCV4463B	2907702
FERODO	FCV1857BFE	CVP024K	FERODO	FCV4725PTS	2931801
FERODO	FCV1914FE	2920200604	FERODO	FCV4736PTS	2932801
FERODO	FCV1914FE	2927801	FERODO	FCV594	2974703
FERODO	FCV1914FE	CVP020K	FERODO	FCV624	2907203
FERODO	FCV1952B	2915102	FERODO	FCV760B	2908302
FERODO	FCV1962B	2927705	FERODO	FCV760B	CVP013K
FERODO	FCV1962B	CVP037K	FERODO	FCV769	2904303
FERODO	FCV1963	2931303	FERODO	FCV770	2903203
FERODO	FCV1963B	2931303	FERODO	FCV773	2901105
FERODO	FCV1964	2931303	FERODO	FCV801	2907503
FERODO	FCV1964B	2931303	FERODO	FCV961	2968801
FERODO	FCV4043	2931302	FERODO	FCV987	2905503
FERODO	FCV4043	2931303	FIAT	5004227	EFR7302
FERODO	FCV4043B	2931302	FIAT	5004229	EFR7303
FERODO	FCV4043B	2931303	FODEN	1487339	CAC011
FERODO	FCV4170B	2917705	FODEN	1489071	CAC001
FERODO	FCV4170B	CVP095K	FODEN	1489198	CAC013
FERODO	FCV4255B	2921101	FODEN	1489199	2927705
FERODO	FCV4281B	2922800604	FODEN	1489199	CVP037K
FERODO	FCV4281B	2922801	FODEN	1489984	2912405
FERODO	FCV4282B	2922701	FODEN	1489984	CVP024K
FERODO	FCV4283	2928502	FODEN	871054	CAC015
FERODO	FCV4283	CVP032K	FRUEHAUF	AJN0018	2925305390
FERODO	FCV4296PTS	2920200604	FRUEHAUF	AJN0018	2927801
FERODO	FCV4296PTS	2927802	FRUEHAUF	AJN0018	CVP020K
FERODO	FCV4311B	2918701	FRUEHAUF	CF103638	EFR6650
FERODO	FCV4344PTS	2920200604	FRUEHAUF	CF103639	EFR6651
FERODO	FCV4344PTS	2927801	FRUEHAUF	CF103758	CAC010
FERODO	FCV4345PTS	2920200604	FRUEHAUF	CF103770	CAC008

Les correspondances de références ont pour seul objectif d'aider la recherche de référence

Cross references are there for the sole purpose of helping the reference search

CORRESPONDANCES DES REFERENCES CROSS REFERENCE LIST

MARQUE/MAKER	REF/PN OES	REF/PN	MARQUE/MAKER	REF/PN OES	REF/PN
FRUEHAUF	CF103907E50	EFR7202	GIGANT	09285158	EFR7300
FRUEHAUF	CF103915	2912405	GIGANT	09285159	EFR7303
FRUEHAUF	CF103915	CVP024K	GIGANT	09285160	EFR7302
FRUEHAUF	CF103974E50	EFR7209	GIGANT	09285161	EFR7301
FRUEHAUF	CF104117E50	EFR7203	GIGANT	09285162	EFR7300
FRUEHAUF	CF104130E50	EFR7300	GIGANT	09285163	EFR7303
FRUEHAUF	CF104131E50	EFR7301	GIGANT	09285164	EFR7302
FRUEHAUF	CF104164E50	EFR7303	GIGANT	09285167	EFR6301
FRUEHAUF	CF104165E50	EFR7302	GIGANT	09285168	EFR6300
FRUEHAUF	CF104249E50	EFR6300	GIGANT	09285257	EFR6006
FRUEHAUF	CF104250E50	EFR6301	GIGANT	09285258	EFR6007
FRUEHAUF	CF104300	CAC012	GIGANT	09285259	EFR7002
FRUEHAUF	CF104301	CAC011	GIGANT	09285260	EFR7003
FRUEHAUF	CF104327	CAC005	GIGANT	09291042	2918302
FRUEHAUF	CF104387	CAC016	GIGANT	16030000	FCV4420B
FRUEHAUF	CF104437E50	EFR6603	GIGANT	19001019	W0610SA
FRUEHAUF	CF104437E75	EFR6603	GIGANT	2100090	EFR7301
FRUEHAUF	CF104438E50	EFR6602	GIGANT	2100091	EFR7300
FRUEHAUF	CF104438E75	EFR6602	GIGANT	2100092	EFR7301
FRUEHAUF	CF104443	CAC015	GIGANT	2100093	EFR7300
FRUEHAUF	CF104458E50	EFR7300	GIGANT	2100192	EFR7301
FRUEHAUF	CF104459E50	EFR7301	GIGANT	2100193	EFR7300
FRUEHAUF	CF104460E50	EFR6300	GIGANT	40800320	EFR6007
FRUEHAUF	CF104461E50	EFR6301	GIGANT	40800330	EFR6006
FRUEHAUF	CF104464E50	EFR7302	GIGANT	50300001	EFR6006
FRUEHAUF	CF104465E50	EFR7303	GIGANT	50302001	EFR6007
FRUEHAUF	CF104474E50	EFR7301	GIGANT	700000538	2933601
FRUEHAUF	CF104475E50	EFR7300	GIGANT	703010372	29xxxxx
FRUEHAUF	CF104542	CAC026	GIGANT	703011017	W0610SA
FRUEHAUF	CF104543	CAC011	GIGANT	709267037	FCR295A
FRUEHAUF	CF104563E400	EFR6650	GIGANT	709267038	FCR295A
FRUEHAUF	CF104563E75	EFR6650	GIGANT	709291064	2918100604
FRUEHAUF	CF104564E400	EFR6651	GIGANT	709291064	2918101
FRUEHAUF	CF104564E75	EFR6651	GIGANT	716030001	FCV4420B
FRUEHAUF	CF104672	CAC009	GIGANT	877930	EFR6006
FRUEHAUF	CF104706	CAC024	GIGANT	877931	EFR6007
FRUEHAUF	CF105116E175	EFR6300	GIGANT	9265165	EFR6301
FRUEHAUF	CF105117E175	EFR6301	GIGANT	9265166	EFR6300
FRUEHAUF	CF105118E275	EFR7692	GIGANT	9267037	FCR295A
FRUEHAUF	CF105119E275	EFR7693	GIGANT	9267038	FCR295A
FRUEHAUF	CF105131E175	EFR7301	GIGANT	9285022	EFR7300
FRUEHAUF	CF105132E175	EFR7300	GIGANT	9285023	EFR7301
FRUEHAUF	CF140032	EFR7630	GIGANT	9285031	EFR6300
FRUEHAUF	CF140033	EFR7631	GIGANT	92850312	EFR6301
FRUEHAUF	M91000101	2932004	GIGANT	9285032	EFR6301
FRUEHAUF	M91000101	CVP036K	GIGANT	92850322	EFR6300
GIGANT	09267086	FCR362A	GIGANT	9285046	EFR7302
GIGANT	09285157	EFR7301	GIGANT	9285047	EFR7303

Les correspondances de références ont pour seul objectif d'aider la recherche de référence

Cross references are there for the sole purpose of helping the reference search

CORRESPONDANCES DES REFERENCES CROSS REFERENCE LIST

MARQUE/MAKER	REF/PN OES	REF/PN	MARQUE/MAKER	REF/PN OES	REF/PN
GIGANT	9285050	EFR5303	HALDEX	89715	EFR7203
GIGANT	9285051	EFR5302	HALDEX	89717	EFR7202
GIGANT	9285098	EFR6300	HALDEX	89718	EFR7202
GIGANT	9285099	EFR6301	HALDEX	89719	EFR7209
GIGANT	9285157	EFR7301	HALDEX	89720	EFR7203
GIGANT	9285158	EFR7300	HALDEX	89721	EFR7202
GIGANT	9285159	EFR7303	HALDEX	89726	EFR7208
GIGANT	9285160	EFR7302	HALDEX	89755	EFR7209
GIGANT	9285161	EFR7301	HALDEX	89774	EFR7208
GIGANT	9285162	EFR7300	HALDEX	89796	2918100604
GIGANT	9285163	EFR7303	HALDEX	89796	2918101
GIGANT	9285164	EFR7302	HALDEX	89895	EFR7209
GIGANT	9285165	EFR6301	HALDEX	89915	EFR7208
GIGANT	9285166	EFR6300	HALDEX	89916	EFR6201
GIGANT	9285167	EFR6301	HALDEX	89947	EFR7209
GIGANT	9285168	EFR6300	HALDEX	89952	EFR7209
GIGANT	9285230	EFR7208	HALDEX	89954	EFR7203
GIGANT	9285245	EFR7204	HALDEX	89975	EFR7203
GIGANT	9285250	EFR7204	HALDEX	90645	EFR7202
GIGANT	9285255	EFR6201	HALDEX	90677	EFR7209
GIGANT	9285256	EFR7204	HALDEX	90678	EFR7203
GIGANT	9285257	EFR6006	HALDEX	90679	EFR7202
GIGANT	9285258	EFR6007	HALDEX	90694	EFR7208
GIGANT	9285259	EFR7002	HALDEX	90717	EFR7209
GIGANT	9285260	EFR7003	HALDEX	90733	EFR6201
GIGANT	9285267	EFR7208	HALDEX	90734	EFR7208
GIGANT	9285282	EFR6201	HALDEX	91030	EFR7209
GIGANT	9291063	2914302	HALDEX	91211	EFR7203
GIGANT	9291073	2918100604	HALDEX	91239	2927802
GIGANT	9291073	2918101	HALDEX	91251	EFR7202
GIGANT	9291073	2932004	HALDEX	91794	EFR7202
GIGANT	9291073	CVP036K	HALDEX	92009	2914302
GIGANT	9291074	2933601	HALDEX	92199	EFR7209
GIGANT	9317202	2927801	HALDEX	92200	EFR7209
GIGANT	93327	2918100604	HALDEX	92201	EFR7203
GIGANT	93327	2918101	HALDEX	92202	EFR7202
GIGANT	M91002703	2914302	HALDEX	92203	EFR7208
GIGANT	M91002704	2914302	HALDEX	92245	EFR6200
HALDEX	81996	EFR7209	HALDEX	92246	EFR6200
HALDEX	81999	EFR7203	HALDEX	92249	EFR6200
HALDEX	87531	EFR7209	HALDEX	92250	EFR6200
HALDEX	87979	EFR7202	HALDEX	92251	EFR6200
HALDEX	882269	EFR7208	HALDEX	92252	EFR6200
HALDEX	89531	EFR7209	HALDEX	92253	EFR6200
HALDEX	89533	EFR7203	HALDEX	92254	EFR6200
HALDEX	89540	EFR7209	HALDEX	92257	EFR6200
HALDEX	89690	EFR7202	HALDEX	92258	EFR6200
HALDEX	89712	EFR7209	HALDEX	92259	EFR6200

Les correspondances de références ont pour seul objectif d'aider la recherche de référence

Cross references are there for the sole purpose of helping the reference search

CORRESPONDANCES DES REFERENCES CROSS REFERENCE LIST

MARQUE/MAKER	REF/PN OES	REF/PN	MARQUE/MAKER	REF/PN OES	REF/PN
HALDEX	92260	EFR6200	HENDRICKSON	98881005	2920200604
HALDEX	92502	EFR7209	HENDRICKSON	98881005	2927801
HALDEX	92503	EFR7209	HENDRICKSON	98881005	CVP020K
HALDEX	92774	EFR7209	HENDRICKSON	HA100159	EFR6626
HALDEX	92776	EFR7208	HENDRICKSON	HA100160	EFR6627
HALDEX	92779	EFR7200	HENDRICKSON	HA100180	EFR6304
HALDEX	92779	EFR7201	HENDRICKSON	HA100181	EFR6305
HALDEX	92779	EFR7202	HENDRICKSON	HB100405	EFR6307
HALDEX	92808	EFR7203	HENDRICKSON	HB100406	EFR6306
HALDEX	92810	EFR7203	HENDRICKSON	HB100410	EFR6317
HALDEX	92824	EFR7204	HENDRICKSON	HB100411	EFR6316
HALDEX	93200	FCV4420B	HENDRICKSON	S269231L	EFR7303
HALDEX	93441	FCV4420B	HENDRICKSON	S269231R	EFR7302
HALDEX	93694	EFR6201	HENDRICKSON	S291522	2920200604
HALDEX	93835	EFR7202	HENDRICKSON	S353031	2933606
HALDEX	93836	EFR7208	HENDRICKSON	S368381	2931302
HALDEX	93839	EFR7202	HENDRICKSON	S368389	CAC022
HALDEX	93840	EFR7203	HENDRICKSON	S368389	CAC023
HALDEX	93841	EFR7204	IRISBUS	2995552	2915001
HALDEX	93842	EFR7204	IRISBUS	2996068	2913105
HALDEX	93887	FCV4420B	IRISBUS	2996068	CVP088K
HALDEX	94605	EFR6200	IRISBUS	2996353	09.8059.20
HALDEX	94608	2918100604	IRISBUS	2996353	93105000
HALDEX	94608	2918101	IRISBUS	2996353	FCR244A
HALDEX	94618	EFR7207	IRISBUS	41200611	09.8059.20
HALDEX	94619	EFR7206	IRISBUS	41200611	93105000
HALDEX	94728	EFR7204	IRISBUS	41200611	FCR244A
HALDEX	94769	EFR6201	IRISBUS	42535061	09.8059.20
HALDEX	95396	FCV4420B	IRISBUS	42535061	93105000
HALDEX	95446	EFR7207	IRISBUS	42535061	FCR244A
HALDEX	95447	EFR7206	IRISBUS	500021159	2913111
HALDEX	95566	2918100604	IRISBUS	500021159	CVP088K
HALDEX	95566	2918101	IRISBUS	500055596	09.8059.20
HALDEX	95620	EFR7206	IRISBUS	500055596	93105000
HALDEX	95620C	EFR7206	IRISBUS	500055596	FCR244A
HALDEX	95621	EFR7207	IRISBUS	500086357	2913111
HALDEX	95621C	EFR7207	IRISBUS	500086357	CVP088K
HALDEX	96150	W0610SA	IRISBUS	5001020312	CVP088K
HALDEX	96304	EFR6202	IRISBUS	5001823000	CVP013K
HALDEX	96305	EFR6203	IRISBUS	5001849922	93243400
HALDEX	96306	29xxxxx	IRISBUS	5001849922	FCR353A
HALDEX	96545	EFR7210	IRISBUS	5001863243	EFR7672
HALDEX	96546	EFR7211	IRISBUS	5001863244	EFR7673
HALDEX	96656	293400956	IRISBUS	5001864545	EFR7674
HENDRICKSON	1134600	09.B325.30	IRISBUS	5001864546	EFR7675
HENDRICKSON	1134600	93087900	IRISBUS	5006028005	CAC007
HENDRICKSON	1134600	DF70000	IRISBUS	5006028410	2913115
HENDRICKSON	1134600	FCR145A	IRISBUS	5006028410	CVP088K

Les correspondances de références ont pour seul objectif d'aider la recherche de référence

Cross references are there for the sole purpose of helping the reference search

CORRESPONDANCES DES REFERENCES CROSS REFERENCE LIST

MARQUE/MAKER	REF/PN OES	REF/PN	MARQUE/MAKER	REF/PN OES	REF/PN
IRISBUS	5006028414	CAC011	IRISBUS	503623714	09.E161.10
IRISBUS	5006028417	CAC001	IRISBUS	503623714	FCR353A
IRISBUS	5006172150	93086100	IRISBUS	504115353	EFR7686
IRISBUS	5006172150	FCR134A	IRISBUS	504115354	EFR7687
IRISBUS	50083553	2913111	IRISBUS	504134958	09.8059.20
IRISBUS	50083553	CVP088K	IRISBUS	504134958	93105000
IRISBUS	5010207432	520.5320.12	IRISBUS	504134958	FCR244A
IRISBUS	5010207433	520.5320.22	IRISBUS	504287479	EFR7664
IRISBUS	5010207434	520.5320.32	IRISBUS	504287480	EFR7665
IRISBUS	5010207435	520.5320.42	IRISBUS	504314990	EFR7664
IRISBUS	5010512467	EFR7674	IRISBUS	504314991	EFR7665
IRISBUS	5010512468	EFR7675	IRISBUS	93162048	CAC005
IRISBUS	5010556273	EFR7672	IVECO	041033394	EFR7304
IRISBUS	5010556274	EFR7673	IVECO	041033395	EFR7305
IRISBUS	501316075	93243400	IVECO	097130542	EFR7300
IRISBUS	501316075	FCR353A	IVECO	097130543	EFR7301
IRISBUS	503126152	93243400	IVECO	099458477	EFR7300
IRISBUS	503126152	FCR353A	IVECO	099458478	EFR7301
IRISBUS	503128110	EFR7685	IVECO	099483108	EFR7300
IRISBUS	503128111	EFR7684	IVECO	099483109	EFR7301
IRISBUS	503128757	CAC011	IVECO	13162033	09.7804.60
IRISBUS	503130944	EFR7686	IVECO	13162033	93127400
IRISBUS	503130945	EFR7687	IVECO	13162033	FCR237A
IRISBUS	503131307	09.E161.10	IVECO	1903651	98025300
IRISBUS	503131307	93243400	IVECO	1903651	W0310IV34
IRISBUS	503131307	FCR353A	IVECO	1904533	09.7873.10
IRISBUS	503131342	CAC040	IVECO	1904534	09.5301.10
IRISBUS	503135255	EFR7611	IVECO	1904534	FCR109A
IRISBUS	503135259	EFR7610	IVECO	1906170	2903203
IRISBUS	503136217	09.E161.10	IVECO	1906191	2901105
IRISBUS	503136217	FCR353A	IVECO	1906438	09.9983.40
IRISBUS	503137561	09.E161.10	IVECO	1906438	93096100
IRISBUS	503137561	FCR353A	IVECO	1906438	FCR173A
IRISBUS	503137965	2913111	IVECO	1906439	2920200604
IRISBUS	503137965	CVP088K	IVECO	1906439	2925305390
IRISBUS	503139523	2913111	IVECO	1906439	2927801
IRISBUS	503139523	CVP088K	IVECO	1906439	CVP020K
IRISBUS	503140088	2913105	IVECO	1906449	09.7804.60
IRISBUS	503140088	2913111	IVECO	1906449	93127400
IRISBUS	503140088	CVP088K	IVECO	1906449	FCR237A
IRISBUS	503140089	2913111	IVECO	1906459	2901105
IRISBUS	503140089	CVP088K	IVECO	1906461	09.9983.40
IRISBUS	503140090	2913111	IVECO	1906461	93096100
IRISBUS	503140090	CVP088K	IVECO	1906461	FCR173A
IRISBUS	503142233	93243400	IVECO	1906466	09.7804.60
IRISBUS	503142233	FCR353A	IVECO	1906466	93127400
IRISBUS	503621049	09.E161.10	IVECO	1906466	FCR237A
IRISBUS	503621049	FCR353A	IVECO	1906467	2928503

Les correspondances de références ont pour seul objectif d'aider la recherche de référence

Cross references are there for the sole purpose of helping the reference search

CORRESPONDANCES DES REFERENCES CROSS REFERENCE LIST

MARQUE/MAKER	REF/PN OES	REF/PN	MARQUE/MAKER	REF/PN OES	REF/PN
IVECO	1906467	CVP032K	IVECO	2992476	2925305390
IVECO	1906468	98031500	IVECO	2992476	2927801
IVECO	1906468	W0365IV1	IVECO	2992476	2927802
IVECO	1906469	09.7286.10	IVECO	2992476	CVP020K
IVECO	1906469	FCR180A	IVECO	2992477	09.9983.10
IVECO	1907568	09.7315.20	IVECO	2992477	93142900
IVECO	1907568	93085000	IVECO	2992477	DF70006
IVECO	1907568	FCR110A	IVECO	2992477	FCR254A
IVECO	1907569	09.7316.20	IVECO	2992479	2901105
IVECO	1907569	93085100	IVECO	2992635	09.7929.90
IVECO	1907569	FCR111A	IVECO	2992635	93188600
IVECO	1907631	09.6739.20	IVECO	2992635	FCR307A
IVECO	1907631	93085200	IVECO	2992636	09.A563.80
IVECO	1907631	FCR132A	IVECO	2992636	93309200
IVECO	1907920	09.7873.10	IVECO	2992636	FCR308A
IVECO	1907956	98022400	IVECO	2992666	98025300
IVECO	1907956	W0400IV	IVECO	2992666	W0310IV34
IVECO	1908231	98022500	IVECO	2992669	2915001
IVECO	1908231	W0250IV	IVECO	2995552	2915001
IVECO	1908614	09.6739.20	IVECO	2995637	2920200604
IVECO	1908614	93085200	IVECO	2995637	2925305390
IVECO	1908614	FCR132A	IVECO	2995637	2927801
IVECO	1908729	09.6739.20	IVECO	2995637	2927802
IVECO	1908729	FCR132A	IVECO	2995637	CVP020K
IVECO	2922088	CAC012	IVECO	2995638	2927801
IVECO	2991979	09.6739.20	IVECO	2995702	09.A562.10
IVECO	2991979	FCR132A	IVECO	2995702	93175200
IVECO	2991990	EFR7300	IVECO	2995702	FCR319A
IVECO	2991991	EFR7301	IVECO	2995809	2920200604
IVECO	2992000	EFR7304	IVECO	2995809	2925305390
IVECO	2992001	EFR7305	IVECO	2995809	2927801
IVECO	2992271	09.A563.40	IVECO	2995809	CVP020K
IVECO	2992271	93127500	IVECO	2995812	09.9983.60
IVECO	2992271	FCR238A	IVECO	2995812	93253000
IVECO	2992291	09.A563.30	IVECO	2995812	DF70007
IVECO	2992291	93127600	IVECO	2995812	FCR318A
IVECO	2992291	FCR239A	IVECO	2995819	2920200604
IVECO	2992336	2932003	IVECO	2995819	2925305390
IVECO	2992336	2932005	IVECO	2995819	2927801
IVECO	2992336	CVP036K	IVECO	2995819	2927802
IVECO	2992348	2920200604	IVECO	2995819	CVP020K
IVECO	2992348	2925305390	IVECO	2995894	09.A562.10
IVECO	2992348	2927801	IVECO	2995894	93175200
IVECO	2992348	CVP020K	IVECO	2995894	FCR319A
IVECO	2992470	09.9983.40	IVECO	2995938	2920200604
IVECO	2992470	93096100	IVECO	2995938	2925305390
IVECO	2992470	FCR173A	IVECO	2995938	2927801
IVECO	2992476	2920200604	IVECO	2995938	CVP020K

Les correspondances de références ont pour seul objectif d'aider la recherche de référence

Cross references are there for the sole purpose of helping the reference search

CORRESPONDANCES DES REFERENCES CROSS REFERENCE LIST

MARQUE/MAKER	REF/PN OES	REF/PN	MARQUE/MAKER	REF/PN OES	REF/PN
IVECO	2996010	93188700	IVECO	2996710	09.A563.80
IVECO	2996010	FCR322A	IVECO	2996710	93309200
IVECO	2996065	2913103	IVECO	2996710	FCR308A
IVECO	2996065	CVP088K	IVECO	2997450	09.7804.60
IVECO	2996189	2927801	IVECO	2997450	93127400
IVECO	2996327	09.9983.10	IVECO	2997450	FCR237A
IVECO	2996327	93142900	IVECO	41033392	EFR7304
IVECO	2996327	DF70006	IVECO	41033392EZ	EFR7304
IVECO	2996327	FCR254A	IVECO	41033393	EFR7305
IVECO	2996328	09.9983.60	IVECO	41033393EZ	EFR7305
IVECO	2996328	93253000	IVECO	41033394	EFR7304
IVECO	2996328	DF70007	IVECO	41033395	EFR7305
IVECO	2996328	FCR318A	IVECO	41211269	EFR7333
IVECO	2996329	09.9983.40	IVECO	41211270	EFR7332
IVECO	2996329	93096100	IVECO	41211271	EFR7333
IVECO	2996329	FCR173A	IVECO	41211272	EFR7332
IVECO	2996378	2920200604	IVECO	41211278	2920200604
IVECO	2996378	2925305390	IVECO	41211278	2925305390
IVECO	2996378	2927801	IVECO	41211278	2927801
IVECO	2996378	2927802	IVECO	41211278	CVP020K
IVECO	2996378	CVP020K	IVECO	41211279	2927801
IVECO	2996418	09.A315.60	IVECO	41211286	EFR7300
IVECO	2996418	93221200	IVECO	41211287	EFR7301
IVECO	2996418	FCR342A	IVECO	41211288	EFR7300
IVECO	2996419	09.A315.10	IVECO	41211289	EFR7301
IVECO	2996419	93221300	IVECO	41211291	2927801
IVECO	2996419	FCR338A	IVECO	41212279	2920200604
IVECO	2996430	2928503	IVECO	41212279	2925305390
IVECO	2996430	CVP032K	IVECO	41212279	2927801
IVECO	2996468	2932003	IVECO	41212279	CVP020K
IVECO	2996468	2932005	IVECO	41285001	EFR7300
IVECO	2996468	CVP036K	IVECO	41285002	EFR7301
IVECO	2996515	2920200604	IVECO	41285003	EFR7300
IVECO	2996515	2925305390	IVECO	41285004	EFR7301
IVECO	2996515	2927801	IVECO	41285006	EFR7333
IVECO	2996515	CVP020K	IVECO	41285007	EFR7332
IVECO	2996706	09.A563.40	IVECO	41285183	EFR7300
IVECO	2996706	93127500	IVECO	41285184	EFR7301
IVECO	2996706	FCR238A	IVECO	41285185	EFR7333
IVECO	2996707	09.A563.30	IVECO	41285186	EFR7332
IVECO	2996707	93127600	IVECO	42037120	09.7873.10
IVECO	2996707	FCR239A	IVECO	42116227	09.7873.10
IVECO	2996708	09.A562.10	IVECO	42535438	EFR6602
IVECO	2996708	93175200	IVECO	42535439	EFR6603
IVECO	2996708	FCR319A	IVECO	42535770	2907503
IVECO	2996709	09.7929.90	IVECO	42535773	2918602
IVECO	2996709	93188600	IVECO	42535775	2907503
IVECO	2996709	FCR307A	IVECO	42535775	2918602

Les correspondances de références ont pour seul objectif d'aider la recherche de référence

Cross references are there for the sole purpose of helping the reference search

CORRESPONDANCES DES REFERENCES CROSS REFERENCE LIST

MARQUE/MAKER	REF/PN OES	REF/PN	MARQUE/MAKER	REF/PN OES	REF/PN
IVECO	42536300	2907503	IVECO	42568133	EFR7300
IVECO	42536300	2918602	IVECO	42568134	EFR7301
IVECO	42536301	2907503	IVECO	42568833	2907503
IVECO	42536301	2918602	IVECO	42568833	2918602
IVECO	42536956	98031500	IVECO	42568838	2907503
IVECO	42536956	W0365IV1	IVECO	42568838	2918602
IVECO	42536957	CAC017	IVECO	42575089	CAC024
IVECO	42537451	CAC005	IVECO	42575089	CAC042
IVECO	42537451	CAC042	IVECO	42575090	EFR6313
IVECO	42538002	CAC024	IVECO	42575091	EFR6312
IVECO	42538002	CAC042	IVECO	42575092	EFR7304
IVECO	42538981	EFR7671	IVECO	42575093	EFR7305
IVECO	42538982	EFR7670	IVECO	42575094	EFR7300
IVECO	42541062	2927801	IVECO	42575095	EFR7301
IVECO	42541277	09.B325.40	IVECO	42575096	EFR6311
IVECO	42541277	93086800	IVECO	42575097	EFR6310
IVECO	42541277	FCR168A	IVECO	4856911	2903203
IVECO	42541341	CAC008	IVECO	4856912	2901105
IVECO	42541412	CAC007	IVECO	500021159	CVP088K
IVECO	42541412	CAC042	IVECO	500034242	EFR7301
IVECO	42541413	CAC009	IVECO	500037231	EFR6309
IVECO	42549008	09.7804.60	IVECO	500037232	EFR6308
IVECO	42549008	93127400	IVECO	500037233	EFR7301
IVECO	42549008	FCR237A	IVECO	500037234	EFR7300
IVECO	42552622	CAC009	IVECO	500037235	EFR6301
IVECO	42553530	CAC008	IVECO	500037236	EFR6300
IVECO	42555201	CAC012	IVECO	500037237	EFR7305
IVECO	42555205	CAC040	IVECO	500037238	EFR7304
IVECO	42555487	EFR6900	IVECO	500037239	EFR7302
IVECO	42555488	EFR6901	IVECO	500037240	EFR7303
IVECO	42557315	09.9983.40	IVECO	500037241	EFR7303
IVECO	42557315	93096100	IVECO	500037243	EFR6301
IVECO	42557315	FCR173A	IVECO	500037244	EFR6302
IVECO	42558850	EFR7300	IVECO	500037245	EFR6303
IVECO	42558851	EFR7301	IVECO	500037246	EFR6300
IVECO	42558852	EFR7304	IVECO	500037247	EFR7302
IVECO	42558853	EFR7305	IVECO	500037248	EFR7300
IVECO	42558854	EFR7333	IVECO	500039935	09.7316.20
IVECO	42558855	EFR7332	IVECO	500039935	93085100
IVECO	42558856	EFR7300	IVECO	500039935	FCR111A
IVECO	42558857	EFR7301	IVECO	500043169	09.B750.10
IVECO	42558858	EFR6310	IVECO	500054632	2920200604
IVECO	42558859	EFR6311	IVECO	500054632	2925305390
IVECO	42558860	EFR6313	IVECO	500054632	2927801
IVECO	42558861	EFR6312	IVECO	500054632	CVP020K
IVECO	42562856	CAC025	IVECO	500055019	2932005
IVECO	42568071	EFR7333	IVECO	500055019	CVP036K
IVECO	42568072	EFR7332	IVECO	500055167	2927801

Les correspondances de références ont pour seul objectif d'aider la recherche de référence

Cross references are there for the sole purpose of helping the reference search

CORRESPONDANCES DES REFERENCES CROSS REFERENCE LIST

MARQUE/MAKER	REF/PN OES	REF/PN	MARQUE/MAKER	REF/PN OES	REF/PN
IVECO	500055372	2928503	IVECO	5801109377	CAC005
IVECO	500055372	CVP032K	IVECO	5801109381	2927801
IVECO	500055566	2920200604	IVECO	5801341078	EFR7300
IVECO	500055656	2932003	IVECO	5801341079	EFR7301
IVECO	500055656	CVP036K	IVECO	5801341080	EFR7300
IVECO	500086003	98025300	IVECO	5801341081	EFR7301
IVECO	500086003	W0310IV34	IVECO	5801341082	EFR7333
IVECO	500086004	2932003	IVECO	5801341083	EFR7332
IVECO	500086004	2932005	IVECO	5801341084	EFR7333
IVECO	500086004	CVP036K	IVECO	5801341085	EFR7332
IVECO	500086211	2920200604	IVECO	5801543639	EFR5003
IVECO	500086211	2925305390	IVECO	5801911087	EFR6313
IVECO	500086211	2927801	IVECO	5801911088	EFR6312
IVECO	500086211	CVP020K	IVECO	7172880	09.7315.20
IVECO	500086357	CVP088K	IVECO	7172880	93085000
IVECO	500328232	EFR5002	IVECO	7172880	FCR110A
IVECO	500328234	EFR5003	IVECO	7172882	09.7315.20
IVECO	500363442	EFR6311	IVECO	7172882	93085000
IVECO	500363443	EFR6310	IVECO	7172882	FCR110A
IVECO	500371649	EFR5002	IVECO	7172928	09.7316.20
IVECO	500371650	EFR5003	IVECO	7172928	93085100
IVECO	50055019	2932005	IVECO	7172928	FCR111A
IVECO	50055019	CVP036K	IVECO	7172930	09.7316.20
IVECO	5006028410	2913115	IVECO	7172930	93085100
IVECO	5006028410	CVP088K	IVECO	7172930	FCR111A
IVECO	5006045908	EFR7300	IVECO	7173317	2901105
IVECO	5006045909	EFR7301	IVECO	7179778	09.9983.40
IVECO	50083553	CVP088K	IVECO	7179778	93096100
IVECO	503126153	EFR7685	IVECO	7179778	FCR173A
IVECO	503136113	2913105	IVECO	7180111	09.6739.20
IVECO	503136113	CVP088K	IVECO	7180111	FCR132A
IVECO	503137965	CVP088K	IVECO	7182199	09.7804.60
IVECO	503139523	CVP088K	IVECO	7182199	93127400
IVECO	503140088	CVP088K	IVECO	7182199	FCR237A
IVECO	503140089	CVP088K	IVECO	7182305	09.9983.40
IVECO	503140090	CVP088K	IVECO	7182305	93096100
IVECO	503142233	09.B750.10	IVECO	7182305	FCR173A
IVECO	503142454	2913105	IVECO	7183632	09.7804.60
IVECO	503142454	CVP088K	IVECO	7183632	93127400
IVECO	503512819	CAC019	IVECO	7183632	FCR237A
IVECO	504045358	EFR6313	IVECO	7183775	09.A563.40
IVECO	504045359	EFR6312	IVECO	7183775	93127500
IVECO	504079033	EFR6313	IVECO	7183775	FCR238A
IVECO	504079034	EFR6312	IVECO	7183776	09.A563.30
IVECO	504185601	EFR6313	IVECO	7183776	93127600
IVECO	504185603	EFR6312	IVECO	7183776	FCR239A
IVECO	504318871	EFR6313	IVECO	7183804	09.A563.40
IVECO	504318872	EFR6312	IVECO	7183804	93127500

Les correspondances de références ont pour seul objectif d'aider la recherche de référence

Cross references are there for the sole purpose of helping the reference search

CORRESPONDANCES DES REFERENCES CROSS REFERENCE LIST

MARQUE/MAKER	REF/PN OES	REF/PN	MARQUE/MAKER	REF/PN OES	REF/PN
IVECO	7183804	FCR238A	IVECO	7189859	FCR238A
IVECO	7183805	09.A563.30	IVECO	7189863	09.A563.80
IVECO	7183805	93127600	IVECO	7189863	93309200
IVECO	7183805	FCR239A	IVECO	7189863	FCR308A
IVECO	7184077	09.7929.90	IVECO	7189864	09.7929.90
IVECO	7184077	93188600	IVECO	7189864	93188600
IVECO	7184077	FCR307A	IVECO	7189864	FCR307A
IVECO	7184078	09.A563.80	IVECO	7189976	09.A562.10
IVECO	7184078	93309200	IVECO	7189976	93175200
IVECO	7184078	FCR308A	IVECO	7189976	FCR319A
IVECO	7184136	09.9983.10	IVECO	8124117	09.5301.10
IVECO	7184136	93142900	IVECO	8124117	FCR109A
IVECO	7184136	DF70006	IVECO	89199336424	CAC005
IVECO	7184136	FCR254A	IVECO	93161191	W0400IV
IVECO	7185503	09.9983.60	IVECO	93161314	2907503
IVECO	7185503	93253000	IVECO	93161314	2918602
IVECO	7185503	DF70007	IVECO	93161407	09.5351.10
IVECO	7185503	FCR318A	IVECO	93161407	93101100
IVECO	7187539	09.A563.80	IVECO	93161407	FCR179A
IVECO	7187539	93309200	IVECO	93162048	CAC005
IVECO	7187539	FCR308A	IVECO	93162048	CAC042
IVECO	7187541	09.A562.10	IVECO	93162050	CAC008
IVECO	7187541	93175200	IVECO	93163056	520.5310.10
IVECO	7187541	FCR319A	IVECO	93163057	520.5310.20
IVECO	7187567	93188700	IVECO	93190874	520.5360.22
IVECO	7187567	FCR322A	IVECO	93190875	520.5360.12
IVECO	7187713	09.7929.90	IVECO	97130542	EFR7300
IVECO	7187713	93188600	IVECO	97130543	EFR7301
IVECO	7187713	FCR307A	IVECO	98120044	2907702
IVECO	7189265	09.A315.10	IVECO	98417405	EFR7900
IVECO	7189265	93221300	IVECO	98417406	EFR7901
IVECO	7189265	FCR338A	IVECO	98447621	EFR6901
IVECO	7189456	09.A315.60	IVECO	98479590	EFR6902
IVECO	7189456	93221200	IVECO	98479591	EFR6903
IVECO	7189456	FCR342A	IVECO	98479613	EFR6900
IVECO	7189475	09.9983.10	IVECO	98479614	EFR6901
IVECO	7189475	93142900	IVECO	99456377	09.7286.10
IVECO	7189475	DF70006	IVECO	99456377	FCR180A
IVECO	7189475	FCR254A	IVECO	99458477	EFR7300
IVECO	7189476	09.9983.60	IVECO	99458478	EFR7301
IVECO	7189476	93253000	IVECO	99458497	EFR7300
IVECO	7189476	DF70007	IVECO	99458498	EFR7301
IVECO	7189476	FCR318A	IVECO	99476098	2920200604
IVECO	7189858	09.A563.30	IVECO	99476098	2925305390
IVECO	7189858	93127600	IVECO	99476098	2927801
IVECO	7189858	FCR239A	IVECO	99476098	CVP020K
IVECO	7189859	09.A563.40	IVECO	99483108	EFR7300
IVECO	7189859	93127500	IVECO	99483109	EFR7301

Les correspondances de références ont pour seul objectif d'aider la recherche de référence

Cross references are there for the sole purpose of helping the reference search

CORRESPONDANCES DES REFERENCES CROSS REFERENCE LIST

MARQUE/MAKER	REF/PN OES	REF/PN	MARQUE/MAKER	REF/PN OES	REF/PN
IVECO	AP06904000	EFR6311	KASSBOHRER	8285443	EFR7606
IVECO	AP06904100	EFR6310	KASSBOHRER	8285444	EFR7607
JOST	JAE0110400012	93276800	KASSBOHRER	8285519000A	EFR7606
JOST	JAE0110400012	FCR346A	KASSBOHRER	8285520000A	EFR7607
JOST	JAE0110400112	09.B325.30	KASSBOHRER	8285515573	2920200604
JOST	JAE0110400112	93087900	KNORR	351605	09.8128.10
JOST	JAE0110400112	DF70000	KNORR	351605	93067600
JOST	JAE0110400112	FCR145A	KNORR	351605	FCR113A
JOST	JAE0250401020	2920200604	KNORR	C55014	CAC008
JOST	JAE0250401020	2925305390	KNORR	II15235	EFR7302
JOST	JAE0250401020	2927801	KNORR	II15498	EFR7303
JOST	JAE0250401020	CVP020K	KNORR	II16059	EFR7302
JOST	JAE0250402601	EFR6300	KNORR	II16060	EFR7302
JOST	JAE0250402701	EFR6301	KNORR	II16069	EFR7303
JOST	JAE0250407020	2925705390	KNORR	II16070	EFR7303
JOST	JAE0250407020	2926900604	KNORR	II16296	CAC006
JOST	JAE0250407020	2926901	KNORR	II16404	93101200
JOST	JAE0250407820	2932004	KNORR	II16404EVO	93101200
JOST	JAE0250407820	CVP036K	KNORR	II17281	EFR7302
JOST	JAE0250408383	EFR7300	KNORR	II17282	EFR7303
JOST	JAE0250408483	EFR7301	KNORR	II179320065	CAC008
JOST	JAE0250409183	EFR6308	KNORR	II17935	EFR7302
JOST	JAE0250409283	EFR6309	KNORR	II17936	EFR7303
JOST	JAE0250410020	293400956	KNORR	II17937	EFR7302
JOST	JAE0250410083	EFR7210	KNORR	II17938	EFR7303
JOST	JAE0250410117	W0610SA	KNORR	II180220062	2920200604
JOST	JAE0250410183	EFR7211	KNORR	II180220062	2924401
KAMAZ	4510435017690	EFR6313	KNORR	II180220062	2927801
KAMAZ	4510435017790	EFR6312	KNORR	II180220062	2927802
KAROSA	2996353	09.8059.20	KNORR	II180220062	2927804
KAROSA	2996353	93105000	KNORR	II180220062	CVP020K
KAROSA	2996353	FCR244A	KNORR	II180220062	FCV4418PTS
KAROSA	5004134958	09.8059.20	KNORR	II183750062	2920200604
KAROSA	5004134958	93105000	KNORR	II183750062	2924401
KAROSA	5004134958	FCR244A	KNORR	II183750062	2927801
KAROSA	68325986	09.8059.20	KNORR	II183750062	2927802
KAROSA	68325986	93105000	KNORR	II183750062	2927804
KAROSA	68325986	FCR244A	KNORR	II183750062	FCV4418PTS
KASSBOHRER	8285000571	2920200604	KNORR	II18547	EFR7300
KASSBOHRER	8285000571	2925305390	KNORR	II18548	EFR7301
KASSBOHRER	8285000571	2927801	KNORR	II18923	EFR7302
KASSBOHRER	8285000571	CVP020K	KNORR	II18924	EFR7303
KASSBOHRER	8285388	EFR7606	KNORR	II18925	EFR7302
KASSBOHRER	8285389	EFR7607	KNORR	II18926	EFR7303
KASSBOHRER	8285408	EFR7606	KNORR	II18927	EFR7302
KASSBOHRER	8285409	EFR7607	KNORR	II18928	EFR7303
KASSBOHRER	8285441	EFR7606	KNORR	II19221	EFR7300
KASSBOHRER	8285442	EFR7607	KNORR	II19222	EFR7301

Les correspondances de références ont pour seul objectif d'aider la recherche de référence

Cross references are there for the sole purpose of helping the reference search

CORRESPONDANCES DES REFERENCES CROSS REFERENCE LIST

MARQUE/MAKER	REF/PN OES	REF/PN	MARQUE/MAKER	REF/PN OES	REF/PN
KNORR	II19245	EFR7300	KNORR	II31018	EFR6301
KNORR	II19246	EFR7301	KNORR	II31018AT	EFR6301
KNORR	II19451	EFR7302	KNORR	II31018M1	EFR6301
KNORR	II19452	EFR7303	KNORR	II31022	EFR7302
KNORR	II19453	EFR6300	KNORR	II31023	EFR7303
KNORR	II19454	EFR6301	KNORR	II31026	EFR7302
KNORR	II19705AT	EFR7302	KNORR	II31027	EFR7303
KNORR	II19706AT	EFR7303	KNORR	II31028	CAC008
KNORR	II19707	EFR7302	KNORR	II31030	EFR7302
KNORR	II19708	EFR7303	KNORR	II31031	EFR7303
KNORR	II197140062	CAC005	KNORR	II310370066	CAC010
KNORR	II19723	EFR7300	KNORR	II31984	EFR7324
KNORR	II19724	EFR7301	KNORR	II31984AT	EFR7324
KNORR	II19725	EFR7300	KNORR	II31985	EFR7325
KNORR	II19726	EFR7301	KNORR	II31985AT	EFR7325
KNORR	II19727	EFR7302	KNORR	II319880062	2920200604
KNORR	II19728	EFR7303	KNORR	II319880062	2924401
KNORR	II197330062	CAC005	KNORR	II319880062	2927801
KNORR	II19737	EFR7302	KNORR	II319880062	FCV4418PTS
KNORR	II19738	EFR7303	KNORR	II32192	EFR6300
KNORR	II19739	EFR7302	KNORR	II32193	EFR6301
KNORR	II19740	EFR7303	KNORR	II32194	EFR6300
KNORR	II30157	EFR7310	KNORR	II32195	EFR6301
KNORR	II30158	EFR7311	KNORR	II32203	EFR7300
KNORR	II30161	EFR6300	KNORR	II32203AT	EFR7300
KNORR	II30162	EFR6301	KNORR	II32204	EFR7301
KNORR	II30175	EFR7302	KNORR	II32204AT	EFR7301
KNORR	II30400	EFR7303	KNORR	II32208	EFR5300
KNORR	II30401	EFR7302	KNORR	II32209	EFR5301
KNORR	II30402	EFR7303	KNORR	II32798	EFR7304
KNORR	II304130065	CAC008	KNORR	II32798A	EFR7304
KNORR	II30418	09.8574.10	KNORR	II32798AT	EFR7304
KNORR	II30418	93101300	KNORR	II32799	EFR7305
KNORR	II30418	FCR186A	KNORR	II32799A	EFR7305
KNORR	II304190061	09.9182.10	KNORR	II32799AT	EFR7305
KNORR	II304190061	93102400	KNORR	II32800	EFR7304
KNORR	II304190061	FCR188A	KNORR	II32800AT	EFR7304
KNORR	II30676	09.8573.10	KNORR	II32801	EFR7305
KNORR	II30676	93101400	KNORR	II32801AT	EFR7305
KNORR	II30676	FCR189A	KNORR	II32802	EFR7304
KNORR	II30677	09.8925.10	KNORR	II32802AT	EFR7304
KNORR	II30677	93101500	KNORR	II32803	EFR7305
KNORR	II30677	FCR190A	KNORR	II32803AT	EFR7305
KNORR	II30692	EFR6300	KNORR	II32804	EFR6307
KNORR	II30693	EFR6301	KNORR	II32805	EFR6306
KNORR	II31017	EFR6300	KNORR	II32806	EFR6304
KNORR	II31017AT	EFR6300	KNORR	II32807	EFR6305
KNORR	II31017M1	EFR6300	KNORR	II32807S	EFR6305

Les correspondances de références ont pour seul objectif d'aider la recherche de référence

Cross references are there for the sole purpose of helping the reference search

CORRESPONDANCES DES REFERENCES CROSS REFERENCE LIST

MARQUE/MAKER	REF/PN OES	REF/PN	MARQUE/MAKER	REF/PN OES	REF/PN
KNORR	I1328090062	CAC005	KNORR	I133978	EFR6301
KNORR	I1328090063	CAC005	KNORR	I133981	EFR7300
KNORR	I132812	EFR7306	KNORR	I133981AT	EFR7300
KNORR	I132812M2	EFR7306	KNORR	I133981V1	EFR7300
KNORR	I132813	EFR7307	KNORR	I133981V2	EFR7300
KNORR	I132813M2	EFR7307	KNORR	I133982	EFR7301
KNORR	I132935	EFR7310	KNORR	I133982AT	EFR7301
KNORR	I132936	EFR7311	KNORR	I133982V1	EFR7301
KNORR	I1329400062	2920200604	KNORR	I133982V2	EFR7301
KNORR	I1329400062	2924401	KNORR	I134161	EFR6300
KNORR	I1329400062	2927801	KNORR	I134161AT	EFR6300
KNORR	I1329400062	2927802	KNORR	I134162	EFR6301
KNORR	I1329400062	2927804	KNORR	I134162AT	EFR6301
KNORR	I1329400062	FCV4418PTS	KNORR	I134315	EFR7302
KNORR	I132941	EFR7302	KNORR	I134316	EFR7303
KNORR	I132942	EFR7303	KNORR	I134317	EFR7302
KNORR	I132955	2903203	KNORR	I134318	EFR7303
KNORR	I132957	2901105	KNORR	I134323	EFR7301
KNORR	I132995	EFR7300	KNORR	I134323AT	EFR7301
KNORR	I132996	EFR7301	KNORR	I134324	EFR7300
KNORR	I133420	EFR7301	KNORR	I134324AT	EFR7300
KNORR	I133421	EFR7300	KNORR	I134325	EFR7301
KNORR	I133428	EFR6300	KNORR	I134326	EFR7300
KNORR	I133429	EFR6301	KNORR	I134452	EFR7302
KNORR	I133430	EFR7302	KNORR	I134453	EFR7303
KNORR	I133430AT	EFR7302	KNORR	I134454	EFR7302
KNORR	I133431	EFR7303	KNORR	I134455	EFR7303
KNORR	I133431AT	EFR7303	KNORR	I134456	EFR7302
KNORR	I133432	EFR7310	KNORR	I134456AT	EFR7302
KNORR	I133432AT	EFR7310	KNORR	I134457	EFR7303
KNORR	I133433	EFR7311	KNORR	I134457AT	EFR7303
KNORR	I133433AT	EFR7311	KNORR	I134458	EFR7302
KNORR	I133640	93086700	KNORR	I134458AT	EFR7302
KNORR	I133640	FCR167A	KNORR	I134459	EFR7303
KNORR	I133758	EFR7304	KNORR	I134459AT	EFR7303
KNORR	I133759	EFR7305	KNORR	I134464	EFR7301
KNORR	I133760	EFR7304	KNORR	I134464AT	EFR7301
KNORR	I133761	EFR7305	KNORR	I134465	EFR7300
KNORR	I133762	EFR7304	KNORR	I134465AT	EFR7300
KNORR	I133763	EFR7305	KNORR	I134475	EFR7304
KNORR	I1339680062	CAC005	KNORR	I134476	EFR7305
KNORR	I1339760062	2920200604	KNORR	I134477	EFR7304
KNORR	I1339760062	2924401	KNORR	I134478	EFR7305
KNORR	I1339760062	2927801	KNORR	I134479	EFR7304
KNORR	I1339760062	2927802	KNORR	I134480	EFR7305
KNORR	I1339760062	2927804	KNORR	I134487	EFR7302
KNORR	I1339760062	FCV4418PTS	KNORR	I134487AT	EFR7302
KNORR	I133977	EFR6300	KNORR	I134488	EFR7303

Les correspondances de références ont pour seul objectif d'aider la recherche de référence

Cross references are there for the sole purpose of helping the reference search

CORRESPONDANCES DES REFERENCES CROSS REFERENCE LIST

MARQUE/MAKER	REF/PN OES	REF/PN	MARQUE/MAKER	REF/PN OES	REF/PN
KNORR	I134488AT	EFR7303	KNORR	I1349450062	2924401
KNORR	I134498	EFR7314	KNORR	I1349450062	2927801
KNORR	I134499	EFR7315	KNORR	I1349450062	2927802
KNORR	I134592	EFR7300	KNORR	I1349450062	2927804
KNORR	I134593	EFR7301	KNORR	I1349450062	FCV4418PTS
KNORR	I134594	EFR7302	KNORR	I1349470062	2920200604
KNORR	I134595	EFR7303	KNORR	I1349470062	2924401
KNORR	I134596	EFR7306	KNORR	I1349470062	2927801
KNORR	I134597	EFR7307	KNORR	I1349470062	2927802
KNORR	I134598	EFR7302	KNORR	I1349470062	2927804
KNORR	I134598AT	EFR7302	KNORR	I1349470062	FCV4418PTS
KNORR	I134599	EFR7303	KNORR	I1350470061	CAC005
KNORR	I134599AT	EFR7303	KNORR	I1350470062	CAC005
KNORR	I134603	EFR7302	KNORR	I135053	EFR7305
KNORR	I134603AT	EFR7302	KNORR	I135054	EFR7304
KNORR	I134604	EFR7303	KNORR	I135055	EFR7305
KNORR	I134604AT	EFR7303	KNORR	I135056	EFR7304
KNORR	I134820	EFR7300	KNORR	I135057	EFR7305
KNORR	I134820AT	EFR7300	KNORR	I135058	EFR7304
KNORR	I134821	EFR7301	KNORR	I1351605	09.8128.10
KNORR	I134821AT	EFR7301	KNORR	I1351605	93067600
KNORR	I134892	EFR6300	KNORR	I1351605	FCR113A
KNORR	I134893	EFR6301	KNORR	I135396	EFR7316
KNORR	I134894	EFR7301	KNORR	I135396AT	EFR7316
KNORR	I134895	EFR7300	KNORR	I135397	EFR7317
KNORR	I134898	EFR7314	KNORR	I135397AT	EFR7317
KNORR	I134898AT	EFR7314	KNORR	I135401	EFR7300
KNORR	I134899	EFR7315	KNORR	I135401AT	EFR7300
KNORR	I134899AT	EFR7315	KNORR	I135402	EFR7301
KNORR	I1349020062	2920200604	KNORR	I135402AT	EFR7301
KNORR	I1349020062	2924401	KNORR	I135403	EFR7302
KNORR	I1349020062	2927801	KNORR	I135404	EFR7303
KNORR	I1349020062	2927802	KNORR	I135540	EFR7302
KNORR	I1349020062	2927804	KNORR	I135540AT	EFR7302
KNORR	I1349020062	FCV4418PTS	KNORR	I135541	EFR7303
KNORR	I1349390062	2920200604	KNORR	I135541AT	EFR7303
KNORR	I1349390062	2924401	KNORR	I135800	EFR7300
KNORR	I1349390062	2927801	KNORR	I135801	EFR7301
KNORR	I1349390062	2927802	KNORR	I135813	EFR7304
KNORR	I1349390062	2927804	KNORR	I135813AT	EFR7304
KNORR	I1349390062	FCV4418PTS	KNORR	I135814	EFR7305
KNORR	I1349410062	2920200604	KNORR	I135814AT	EFR7305
KNORR	I1349410062	2924401	KNORR	I135815	EFR7304
KNORR	I1349410062	2927801	KNORR	I135815AT	EFR7304
KNORR	I1349410062	2927802	KNORR	I135816	EFR7305
KNORR	I1349410062	2927804	KNORR	I135816AT	EFR7305
KNORR	I1349410062	FCV4418PTS	KNORR	I135838	EFR7304
KNORR	I1349450062	2920200604	KNORR	I135838AT	EFR7304

Les correspondances de références ont pour seul objectif d'aider la recherche de référence

Cross references are there for the sole purpose of helping the reference search

CORRESPONDANCES DES REFERENCES CROSS REFERENCE LIST

MARQUE/MAKER	REF/PN OES	REF/PN	MARQUE/MAKER	REF/PN OES	REF/PN
KNORR	I135839	EFR7305	KNORR	I136702	EFR6305
KNORR	I135839AT	EFR7305	KNORR	I136702AT	EFR6305
KNORR	I1358510062	CAC005	KNORR	I136703	EFR6307
KNORR	I135957	EFR7302	KNORR	I136704	EFR6306
KNORR	I135958	EFR7303	KNORR	I136705	EFR6304
KNORR	I135964	EFR7302	KNORR	I136705AT	EFR6304
KNORR	I135965	EFR7303	KNORR	I136706	EFR6305
KNORR	I136430	EFR7314	KNORR	I136706AT	EFR6305
KNORR	I136430AT	EFR7314	KNORR	I136767	EFR7300
KNORR	I136431	EFR7315	KNORR	I136768	EFR7301
KNORR	I136431AT	EFR7315	KNORR	I136769	EFR7302
KNORR	I136490	EFR7302	KNORR	I136770	EFR7303
KNORR	I136490AT	EFR7302	KNORR	I136802	EFR7304
KNORR	I136491	EFR7303	KNORR	I136803	EFR7305
KNORR	I136491AT	EFR7303	KNORR	I136804	EFR7308
KNORR	I136503	EFR7324	KNORR	I136805	EFR7309
KNORR	I136504	EFR7325	KNORR	I136806	EFR7300
KNORR	I136681	EFR5303	KNORR	I136807	EFR7301
KNORR	I136681AT	EFR5303	KNORR	I136808	EFR7304
KNORR	I136682	EFR5302	KNORR	I136809	EFR7305
KNORR	I136682AT	EFR5302	KNORR	I136815	EFR7304
KNORR	I136683	EFR5301	KNORR	I1369100062	CAC005
KNORR	I136683AT	EFR5301	KNORR	I136917	2918302
KNORR	I136684	EFR5300	KNORR	I136991	2918302
KNORR	I136684AT	EFR5300	KNORR	I136999	EFR7304
KNORR	I136685	EFR5303	KNORR	I136999AT	EFR7304
KNORR	I136685AT	EFR5303	KNORR	I137000	EFR7305
KNORR	I136686	EFR5302	KNORR	I137000AT	EFR7305
KNORR	I136687	EFR5301	KNORR	I137001	EFR7310
KNORR	I136688	EFR5300	KNORR	I137001AT	EFR7310
KNORR	I136689	EFR7304	KNORR	I137001AT	EFR7310
KNORR	I136689AT	EFR7304	KNORR	I137002	EFR7311
KNORR	I136690	EFR7305	KNORR	I137002AT	EFR7311
KNORR	I136690AT	EFR7305	KNORR	I137002AT	EFR7311
KNORR	I136691	EFR7304	KNORR	I137006	EFR7300
KNORR	I136691AT	EFR7304	KNORR	I137006AT	EFR7300
KNORR	I136692	EFR7305	KNORR	I137007	EFR7301
KNORR	I136692AT	EFR7305	KNORR	I137007AT	EFR7301
KNORR	I136693	EFR7304	KNORR	I137010	EFR7302
KNORR	I136693AT	EFR7304	KNORR	I137012	EFR7303
KNORR	I136694	EFR7305	KNORR	I137013	EFR7302
KNORR	I136694AT	EFR7305	KNORR	I137014	EFR7303
KNORR	I136699	EFR6307	KNORR	I137015	EFR7302
KNORR	I136699AT	EFR6307	KNORR	I137015AT	EFR7302
KNORR	I136700	EFR6306	KNORR	I137016	EFR7303
KNORR	I136700AT	EFR6306	KNORR	I137016AT	EFR7303
KNORR	I136701	EFR6304	KNORR	I137017	EFR7302
KNORR	I136701AT	EFR6304	KNORR	I137017AT	EFR7302

Les correspondances de références ont pour seul objectif d'aider la recherche de référence

Cross references are there for the sole purpose of helping the reference search

CORRESPONDANCES DES REFERENCES CROSS REFERENCE LIST

MARQUE/MAKER	REF/PN OES	REF/PN	MARQUE/MAKER	REF/PN OES	REF/PN
KNORR	II37018	EFR7303	KNORR	II37221	EFR6304
KNORR	II37018AT	EFR7303	KNORR	II37222	EFR6305
KNORR	II37019	EFR7302	KNORR	II37223	EFR6300
KNORR	II37019AT	EFR7302	KNORR	II37223AT	EFR6300
KNORR	II37020	EFR7303	KNORR	II37224	EFR6301
KNORR	II37020AT	EFR7303	KNORR	II37224AT	EFR6301
KNORR	II37021	EFR7302	KNORR	II37225	EFR6300
KNORR	II37022	EFR7303	KNORR	II37226	EFR6301
KNORR	II37025	EFR6304	KNORR	II37229	EFR7310
KNORR	II37025AT	EFR6304	KNORR	II37230	EFR7311
KNORR	II37026	EFR6305	KNORR	II37231	EFR7310
KNORR	II37026AT	EFR6305	KNORR	II37231AT	EFR7310
KNORR	II37029	EFR7302	KNORR	II37232	EFR7311
KNORR	II37029AT	EFR7302	KNORR	II37232AT	EFR7311
KNORR	II37030	EFR7303	KNORR	II37233	EFR7310
KNORR	II37030AT	EFR7303	KNORR	II37234	EFR7311
KNORR	II37061	EFR7304	KNORR	II37236	EFR7302
KNORR	II37061AT	EFR7304	KNORR	II37237	EFR7303
KNORR	II37061DC	EFR7304	KNORR	II37239	EFR7302
KNORR	II37062	EFR7305	KNORR	II37240	EFR7303
KNORR	II37062AT	EFR7305	KNORR	II37246	EFR7304
KNORR	II37062DC	EFR7305	KNORR	II37246AT	EFR7304
KNORR	II37063	EFR7304	KNORR	II37247	EFR7305
KNORR	II37063AT	EFR7304	KNORR	II37247AT	EFR7305
KNORR	II37064	EFR7305	KNORR	II37248	EFR7304
KNORR	II37064AT	EFR7305	KNORR	II37249	EFR7305
KNORR	II37068	EFR7310	KNORR	II37252	EFR6300
KNORR	II37069	EFR7311	KNORR	II37253	EFR6301
KNORR	II37070	EFR7312	KNORR	II37380	EFR7310
KNORR	II37071	EFR7313	KNORR	II37381	EFR7311
KNORR	II37072	EFR7312	KNORR	II37390	EFR7300
KNORR	II37073	EFR7313	KNORR	II37390AT	EFR7300
KNORR	II37077	EFR7304	KNORR	II37391	EFR7301
KNORR	II37077AT	EFR7304	KNORR	II37391AT	EFR7301
KNORR	II37078	EFR7305	KNORR	II37392	EFR7310
KNORR	II37078AT	EFR7305	KNORR	II37392AT	EFR7310
KNORR	II37080	EFR7302	KNORR	II37393	EFR7311
KNORR	II37080AT	EFR7302	KNORR	II37393AT	EFR7311
KNORR	II37081	EFR7303	KNORR	II37394	EFR7304
KNORR	II37081AT	EFR7303	KNORR	II37395	EFR7305
KNORR	II37191	09.B325.40	KNORR	II37398	EFR7304
KNORR	II37191	93086800	KNORR	II37398AT	EFR7304
KNORR	II37191	FCR168A	KNORR	II37399	EFR7305
KNORR	II371910061	09.B325.40	KNORR	II37399AT	EFR7305
KNORR	II371910061	93086800	KNORR	II37415	93101200
KNORR	II371910061	FCR168A	KNORR	II37419	EFR7302
KNORR	II37209	EFR7310	KNORR	II37420	EFR7303
KNORR	II37210	EFR7311	KNORR	II37421	EFR7302

Les correspondances de références ont pour seul objectif d'aider la recherche de référence

Cross references are there for the sole purpose of helping the reference search

CORRESPONDANCES DES REFERENCES CROSS REFERENCE LIST

MARQUE/MAKER	REF/PN OES	REF/PN	MARQUE/MAKER	REF/PN OES	REF/PN
KNORR	II37421AT	EFR7302	KNORR	II37700	EFR7300
KNORR	II37422	EFR7303	KNORR	II37701	EFR7301
KNORR	II37422AT	EFR7303	KNORR	II37702	EFR7304
KNORR	II37423	EFR7324	KNORR	II37703	EFR7305
KNORR	II37423AT	EFR7324	KNORR	II37761	2918302
KNORR	II37423M1	EFR7324	KNORR	II37783	09.8793.10
KNORR	II37423M1AT	EFR7324	KNORR	II37791	EFR7302
KNORR	II37424	EFR7325	KNORR	II37791AT	EFR7302
KNORR	II37424AT	EFR7325	KNORR	II37792	EFR7303
KNORR	II37424M1	EFR7325	KNORR	II37792AT	EFR7303
KNORR	II37424M1AT	EFR7325	KNORR	II37793	EFR7300
KNORR	II376320062	2920200604	KNORR	II37793AT	EFR7300
KNORR	II376320062	2924401	KNORR	II37794	EFR7301
KNORR	II376320062	2927801	KNORR	II37794AT	EFR7301
KNORR	II376320062	2927802	KNORR	II37795	EFR7300
KNORR	II376320062	2927804	KNORR	II37795AT	EFR7300
KNORR	II376320062	FCV4418PTS	KNORR	II37796	EFR7301
KNORR	II37638	09.B325.30	KNORR	II37796AT	EFR7301
KNORR	II37638	93087900	KNORR	II37797	EFR6304
KNORR	II37638	DF70000	KNORR	II37797AT	EFR6304
KNORR	II37638	FCR145A	KNORR	II37798	EFR6305
KNORR	II376380061	09.B325.30	KNORR	II37798AT	EFR6305
KNORR	II376380061	93087900	KNORR	II37799	EFR6304
KNORR	II376380061	DF70000	KNORR	II37799AT	EFR6304
KNORR	II376380061	FCR145A	KNORR	II37799-K	EFR6304
KNORR	II37649	EFR7302	KNORR	II37800	EFR6305
KNORR	II37650	EFR7303	KNORR	II37800AT	EFR6305
KNORR	II37654	09.9983.40	KNORR	II37800-K	EFR6305
KNORR	II37654	93096100	KNORR	II37801	EFR6304
KNORR	II37654	FCR173A	KNORR	II37801AT	EFR6304
KNORR	II376580062	2932004	KNORR	II37801AT	EFR6304
KNORR	II376580062	CVP036K	KNORR	II37802	EFR6305
KNORR	II37686	EFR6300	KNORR	II37802AT	EFR6305
KNORR	II37686AT	EFR6300	KNORR	II37803	EFR5303
KNORR	II37687	EFR6301	KNORR	II37803AT	EFR5303
KNORR	II37687AT	EFR6301	KNORR	II37803DC	EFR5303
KNORR	II37690	EFR6302	KNORR	II37804	EFR5302
KNORR	II37690AT	EFR6302	KNORR	II37804AT	EFR5302
KNORR	II37691	EFR6303	KNORR	II37804DC	EFR5302
KNORR	II37691AT	EFR6303	KNORR	II37805	EFR5303
KNORR	II37692	EFR7300	KNORR	II37805AT	EFR5303
KNORR	II37693	EFR7301	KNORR	II37806	EFR5302
KNORR	II37694	EFR7302	KNORR	II37806AT	EFR5302
KNORR	II37695	EFR7303	KNORR	II37808	EFR7300
KNORR	II37696	EFR7304	KNORR	II37808AT	EFR7300
KNORR	II37697	EFR7305	KNORR	II37808M1	EFR7300
KNORR	II37698	EFR7308	KNORR	II37809	EFR7301
KNORR	II37699	EFR7309	KNORR	II37809AT	EFR7301

Les correspondances de références ont pour seul objectif d'aider la recherche de référence

Cross references are there for the sole purpose of helping the reference search

CORRESPONDANCES DES REFERENCES CROSS REFERENCE LIST

MARQUE/MAKER	REF/PN OES	REF/PN	MARQUE/MAKER	REF/PN OES	REF/PN
KNORR	II37810	EFR6300	KNORR	II38341F	EFR7307
KNORR	II37810AT	EFR6300	KNORR	II38341FAT	EFR7307
KNORR	II37811	EFR6301	KNORR	II38341FM1	EFR7307
KNORR	II37811AT	EFR6301	KNORR	II38342F	EFR7324
KNORR	II37812	EFR7314	KNORR	II38343F	EFR7325
KNORR	II37812AT	EFR7314	KNORR	II38344F	EFR7306
KNORR	II37812AT	EFR7314	KNORR	II38344FM1	EFR7306
KNORR	II37812M1	EFR7314	KNORR	II38345F	EFR7307
KNORR	II37813	EFR7315	KNORR	II38345FM1	EFR7307
KNORR	II37813AT	EFR7315	KNORR	II38346FM062	CAC005
KNORR	II37813AT	EFR7315	KNORR	II38350F	EFR7300
KNORR	II37813M1	EFR7315	KNORR	II38350FAT	EFR7300
KNORR	II37814	EFR7316	KNORR	II38351F	EFR7301
KNORR	II37814AT	EFR7316	KNORR	II38351FAT	EFR7301
KNORR	II37814M1	EFR7316	KNORR	II38352F	EFR7300
KNORR	II37814M4	EFR7316	KNORR	II38352FAT	EFR7300
KNORR	II37814M5	EFR7316	KNORR	II38353F	EFR7301
KNORR	II37815	EFR7317	KNORR	II38353FAT	EFR7301
KNORR	II37815AT	EFR7317	KNORR	II38363F	EFR7300
KNORR	II37815M1	EFR7317	KNORR	II38364F	EFR7301
KNORR	II37815M4	EFR7317	KNORR	II38365F	EFR6310
KNORR	II37815M5	EFR7317	KNORR	II38366F	EFR6311
KNORR	II37816	EFR7314	KNORR	II38367F	EFR7310
KNORR	II37816AT	EFR7314	KNORR	II38368F	EFR7311
KNORR	II37816M1	EFR7314	KNORR	II38621F	2920200604
KNORR	II37817	EFR7315	KNORR	II38621F	2927801
KNORR	II37817AT	EFR7315	KNORR	II38630F	EFR7310
KNORR	II37817M1	EFR7315	KNORR	II38630F1	EFR7310
KNORR	II37818	EFR7324	KNORR	II38631F	EFR7311
KNORR	II37818M1	EFR7324	KNORR	II38631F1	EFR7311
KNORR	II37819	EFR7325	KNORR	II38632F	EFR5303
KNORR	II37819M1	EFR7325	KNORR	II38633F	EFR5302
KNORR	II38036F	EFR7316	KNORR	II38648F	EFR7314
KNORR	II38037F	EFR7317	KNORR	II38648FAT	EFR7314
KNORR	II38038F	EFR7300	KNORR	II38648FM1	EFR7314
KNORR	II38038FAT	EFR7300	KNORR	II38649F	EFR7315
KNORR	II38039F	EFR7301	KNORR	II38649FAT	EFR7315
KNORR	II38039FAT	EFR7301	KNORR	II38649FM1	EFR7315
KNORR	II38042F	EFR6307	KNORR	II38694F	EFR7312
KNORR	II38043F	EFR6306	KNORR	II38695F	EFR7313
KNORR	II38046F	EFR7300	KNORR	II38696F	EFR7312
KNORR	II38047F	EFR7301	KNORR	II38697F	EFR7313
KNORR	II38157F0062	2918302	KNORR	II38722F	EFR6300
KNORR	II38333F	2920200604	KNORR	II38723F	EFR6301
KNORR	II38333F	2927801	KNORR	II38724F	EFR7304
KNORR	II38340F	EFR7306	KNORR	II38724FAT	EFR7304
KNORR	II38340FAT	EFR7306	KNORR	II38725F	EFR7305
KNORR	II38340FM1	EFR7306	KNORR	II38725FAT	EFR7305

Les correspondances de références ont pour seul objectif d'aider la recherche de référence

Cross references are there for the sole purpose of helping the reference search

CORRESPONDANCES DES REFERENCES CROSS REFERENCE LIST

MARQUE/MAKER	REF/PN OES	REF/PN	MARQUE/MAKER	REF/PN OES	REF/PN
KNORR	II38726F	EFR7304	KNORR	II39034F	EFR7302
KNORR	II38726FAT	EFR7304	KNORR	II39034FAT	EFR7302
KNORR	II38727F	EFR7305	KNORR	II39035F	EFR7303
KNORR	II38727FAT	EFR7305	KNORR	II39035FAT	EFR7303
KNORR	II38728F	EFR7304	KNORR	II39036F	EFR6300
KNORR	II38728FAT	EFR7304	KNORR	II39036FAT	EFR6300
KNORR	II38729F	EFR7305	KNORR	II39037F	EFR6301
KNORR	II38729FAT	EFR7305	KNORR	II39037FAT	EFR6301
KNORR	II38730F	EFR7312	KNORR	II39038F	EFR6300
KNORR	II38731F	EFR7313	KNORR	II39038FAT	EFR6300
KNORR	II38737F	EFR7300	KNORR	II39039F	EFR6301
KNORR	II38738F	EFR7301	KNORR	II39044F	EFR7302
KNORR	II38810F	EFR7300	KNORR	II39044FAT	EFR7302
KNORR	II38810FAT	EFR7300	KNORR	II39045F	EFR7303
KNORR	II38811F	EFR7301	KNORR	II39045FAT	EFR7303
KNORR	II38811FAT	EFR7301	KNORR	II39046F	EFR6300
KNORR	II38816F	EFR7310	KNORR	II39046FAT	EFR6300
KNORR	II38816FAT	EFR7308	KNORR	II39047F	EFR6301
KNORR	II38817F	EFR7311	KNORR	II39047FAT	EFR6301
KNORR	II38817FAT	EFR7309	KNORR	II39048F	EFR6302
KNORR	II38818F	EFR6307	KNORR	II39048FAT	EFR6302
KNORR	II38819F	EFR6306	KNORR	II39049F	EFR6303
KNORR	II38822F	EFR6307	KNORR	II39049FAT	EFR6303
KNORR	II38823F	EFR6306	KNORR	II39068F	EFR6300
KNORR	II38824F	EFR7310	KNORR	II39068FAT	EFR6300
KNORR	II38825F	EFR7311	KNORR	II39069F	EFR6301
KNORR	II38826F	EFR7310	KNORR	II39069FAT	EFR6301
KNORR	II38827F	EFR7311	KNORR	II39098F	09.6739.20
KNORR	II38863F0062	2920200604	KNORR	II39098F	FCR132A
KNORR	II38863F0062	2927801	KNORR	II39100F	2911303
KNORR	II39000F	EFR7312	KNORR	II39102F	2905503
KNORR	II39001F	EFR7313	KNORR	II39106F	2909006
KNORR	II39002F	EFR7314	KNORR	II39106F	CVP023K
KNORR	II39002FAT	EFR7314	KNORR	II39107F	2911303
KNORR	II39003F	EFR7315	KNORR	II39251F	EFR6300
KNORR	II39003FAT	EFR7315	KNORR	II39251FAT	EFR6300
KNORR	II39004F	EFR7306	KNORR	II39252F	EFR6301
KNORR	II39005F	EFR7307	KNORR	II39252FAT	EFR6301
KNORR	II39006F	EFR7316	KNORR	II39258F	EFR6311
KNORR	II39006FAT	EFR7316	KNORR	II39258FAT	EFR6311
KNORR	II39007F	EFR7317	KNORR	II39258FIV	EFR6311
KNORR	II39007FAT	EFR7317	KNORR	II39259F	EFR6310
KNORR	II39008F	EFR7314	KNORR	II39259FAT	EFR6310
KNORR	II39009F	EFR7315	KNORR	II39259FIV	EFR6310
KNORR	II39030F	EFR7314	KNORR	II39262F	EFR7310
KNORR	II39031F	EFR7315	KNORR	II39262FAT	EFR7310
KNORR	II39032F	EFR7314	KNORR	II39263F	EFR7311
KNORR	II39033F	EFR7315	KNORR	II39263FAT	EFR7311

Les correspondances de références ont pour seul objectif d'aider la recherche de référence

Cross references are there for the sole purpose of helping the reference search

CORRESPONDANCES DES REFERENCES CROSS REFERENCE LIST

MARQUE/MAKER	REF/PN OES	REF/PN	MARQUE/MAKER	REF/PN OES	REF/PN
KNORR	II39264F	EFR7300	KNORR	K000005AT	EFR6302
KNORR	II39265F	EFR7301	KNORR	K000006	EFR6303
KNORR	II39266F	EFR6300	KNORR	K000007	EFR7302
KNORR	II39267F	EFR6301	KNORR	K000007AT	EFR7302
KNORR	II39274F	EFR6304	KNORR	K000008	EFR7303
KNORR	II39275F	EFR6305	KNORR	K000011	EFR7302
KNORR	II39290F	09.A461.10	KNORR	K000012	EFR7303
KNORR	II39290F	93086900	KNORR	K000035	EFR7314
KNORR	II39290F	FCR147A	KNORR	K000035AT	EFR7314
KNORR	II39294F	EFR7302	KNORR	K000036	EFR7315
KNORR	II39295F	EFR7303	KNORR	K000036AT	EFR7315
KNORR	II39298F	EFR7316	KNORR	K000037	EFR7314
KNORR	II39299F	EFR7317	KNORR	K000038	EFR7315
KNORR	II39459F	2907203	KNORR	K000039	EFR7316
KNORR	II39515F	EFR7304	KNORR	K000040	EFR7317
KNORR	II39516F	EFR7305	KNORR	K000041	EFR7316
KNORR	II39537F	EFR7304	KNORR	K000042	EFR7317
KNORR	II39538F	EFR7305	KNORR	K000043	EFR7302
KNORR	II39539F	EFR7304	KNORR	K000044	EFR7303
KNORR	II39540F	EFR7305	KNORR	K000045	EFR7310
KNORR	II39541F	93145600	KNORR	K000046	EFR7311
KNORR	II39541F	DF70004+	KNORR	K000051	EFR7300
KNORR	II39541F	FCR225A	KNORR	K000051AT	EFR7300
KNORR	II39544F	EFR7308	KNORR	K000052	EFR7301
KNORR	II39544FAT	EFR7308	KNORR	K000052AT	EFR7301
KNORR	II39545F	EFR7309	KNORR	K000053	EFR7304
KNORR	II39545FAT	EFR7309	KNORR	K000054	EFR7305
KNORR	II39769F0062	CAC005	KNORR	K000091	EFR7300
KNORR	II39842	EFR7304	KNORR	K000092	EFR7301
KNORR	II39843	EFR7305	KNORR	K000093	EFR7302
KNORR	II39844	EFR7316	KNORR	K000094	EFR7303
KNORR	II39844F	EFR7316	KNORR	K000095	EFR6300
KNORR	II39845	EFR7317	KNORR	K000096	EFR6301
KNORR	II39845F	EFR7317	KNORR	K000097	EFR6300
KNORR	II39846	EFR7310	KNORR	K000098	EFR6301
KNORR	II39847	EFR7311	KNORR	K000105	EFR6300
KNORR	II39848	EFR7304	KNORR	K000106	EFR6301
KNORR	II39849	EFR7305	KNORR	K000115	EFR6300
KNORR	II40009F	EFR5304	KNORR	K000116	EFR6301
KNORR	II40010F	EFR5305	KNORR	K000116AT	EFR6301
KNORR	II40232F	EFR7300	KNORR	K000117	EFR7302
KNORR	II40233F	EFR7301	KNORR	K000118	EFR7303
KNORR	II40242FM3	EFR7326	KNORR	K000119	EFR7302
KNORR	II40243FM3	EFR7327	KNORR	K000120	EFR7303
KNORR	K000002	EFR7308	KNORR	K000136	EFR7302
KNORR	K000003	EFR7309	KNORR	K000136AT	EFR7302
KNORR	K000004	CAC010	KNORR	K000137	EFR7303
KNORR	K000005	EFR6302	KNORR	K000137AT	EFR7303

Les correspondances de références ont pour seul objectif d'aider la recherche de référence

Cross references are there for the sole purpose of helping the reference search

CORRESPONDANCES DES REFERENCES CROSS REFERENCE LIST

MARQUE/MAKER	REF/PN OES	REF/PN	MARQUE/MAKER	REF/PN OES	REF/PN
KNORR	K000138	EFR7300	KNORR	K000304	EFR7304
KNORR	K000139	EFR7301	KNORR	K000305	EFR7305
KNORR	K000166	EFR7314	KNORR	K000306	EFR7304
KNORR	K000167	EFR7315	KNORR	K000306AT	EFR7304
KNORR	K000202	EFR7300	KNORR	K000307	EFR7305
KNORR	K000203	EFR7301	KNORR	K000307AT	EFR7305
KNORR	K000204	EFR7300	KNORR	K000308	EFR7304
KNORR	K000205	EFR7301	KNORR	K000309	EFR7305
KNORR	K000206	EFR7300	KNORR	K000310	EFR7304
KNORR	K000207	EFR7301	KNORR	K000311	EFR7305
KNORR	K000208	EFR7300	KNORR	K000312	EFR7304
KNORR	K000209	EFR7301	KNORR	K000313	EFR7305
KNORR	K000210	EFR6300	KNORR	K000314	EFR7304
KNORR	K000210AT	EFR6300	KNORR	K000315	EFR7305
KNORR	K000211	EFR6301	KNORR	K000316	EFR7304
KNORR	K000211AT	EFR6301	KNORR	K000317	EFR7305
KNORR	K000212	EFR6300	KNORR	K000320	EFR7302
KNORR	K000213	EFR6301	KNORR	K000321	EFR7303
KNORR	K000214	EFR6300	KNORR	K000322	EFR6300
KNORR	K000215	EFR6301	KNORR	K000323	EFR6301
KNORR	K000216	EFR6300	KNORR	K000356	CAC010
KNORR	K000217	EFR6301	KNORR	K000366	CAC009
KNORR	K000258	EFR7324	KNORR	K000375	CAC024
KNORR	K000258AT	EFR7324	KNORR	K000386	EFR7308
KNORR	K000258SC	EFR7324	KNORR	K000386AT	EFR7308
KNORR	K000258SX	EFR7324	KNORR	K000387	EFR7309
KNORR	K000259	EFR7325	KNORR	K000387AT	EFR7309
KNORR	K000259AT	EFR7325	KNORR	K000412	EFR7300
KNORR	K000259SC	EFR7325	KNORR	K000412AT	EFR7300
KNORR	K000259SX	EFR7325	KNORR	K000412IV	EFR7300
KNORR	K000260	EFR7304	KNORR	K000413	EFR7301
KNORR	K000260AT	EFR7304	KNORR	K000413AT	EFR7301
KNORR	K000260IV	EFR7304	KNORR	K000413IV	EFR7301
KNORR	K000261	EFR7305	KNORR	K000422	CAC010
KNORR	K000261AT	EFR7305	KNORR	K000445	EFR7300
KNORR	K000261IV	EFR7305	KNORR	K000445SX	EFR7300
KNORR	K000262	EFR7306	KNORR	K000446	EFR7301
KNORR	K000263	EFR7307	KNORR	K000446SX	EFR7301
KNORR	K000266	EFR7302	KNORR	K000447	EFR7300
KNORR	K000267	EFR7303	KNORR	K000448	EFR7301
KNORR	K000279	EFR5300	KNORR	K000449	EFR7300
KNORR	K000280	EFR5301	KNORR	K000450	EFR7301
KNORR	K000281	EFR5301	KNORR	K000464	2932003
KNORR	K000282	EFR5300	KNORR	K000464	2932005
KNORR	K000300	EFR6300	KNORR	K000464	CVP036K
KNORR	K000301	EFR6301	KNORR	K000472	CAC007
KNORR	K000302	EFR7304	KNORR	K000474	EFR7300
KNORR	K000303	EFR7305	KNORR	K000475	EFR7301

Les correspondances de références ont pour seul objectif d'aider la recherche de référence

Cross references are there for the sole purpose of helping the reference search

CORRESPONDANCES DES REFERENCES CROSS REFERENCE LIST

MARQUE/MAKER	REF/PN OES	REF/PN	MARQUE/MAKER	REF/PN OES	REF/PN
KNORR	K000476	EFR7300	KNORR	K000781	EFR7303
KNORR	K000476SX	EFR7300	KNORR	K000782	EFR7304
KNORR	K000477	EFR7301	KNORR	K000782AT	EFR7304
KNORR	K000477SX	EFR7301	KNORR	K000783	EFR7305
KNORR	K000485	EFR7314	KNORR	K000783AT	EFR7305
KNORR	K000485AT	EFR7314	KNORR	K000786	EFR7310
KNORR	K000486	EFR7315	KNORR	K000787	EFR7311
KNORR	K000486AT	EFR7315	KNORR	K000790	EFR7300
KNORR	K000487	EFR7310	KNORR	K000791	EFR7301
KNORR	K000488	EFR7311	KNORR	K000810	09.A995.10
KNORR	K000502	EFR7304	KNORR	K000810	93088300
KNORR	K000503	EFR7305	KNORR	K000810	DF70003
KNORR	K000504	EFR7308	KNORR	K000810	FCR170A
KNORR	K000505	EFR7309	KNORR	K000815	EFR7312
KNORR	K000517	EFR7300	KNORR	K000815AT	EFR7312
KNORR	K000517AT	EFR7300	KNORR	K000816	EFR7313
KNORR	K000518	EFR7301	KNORR	K000816AT	EFR7313
KNORR	K000518AT	EFR7301	KNORR	K000822	EFR7300
KNORR	K000550	EFR7300	KNORR	K000823	EFR7301
KNORR	K000551	EFR7301	KNORR	K000826	EFR7302
KNORR	K000552	EFR7302	KNORR	K000827	EFR7303
KNORR	K000553	EFR7303	KNORR	K000830	EFR7312
KNORR	K000564	EFR7302	KNORR	K000831	EFR7313
KNORR	K000565	EFR7303	KNORR	K000849	EFR7333
KNORR	K000566	EFR7308	KNORR	K000850	EFR7332
KNORR	K000567	EFR7309	KNORR	K000851	EFR7300
KNORR	K000571	EFR7300	KNORR	K000851IV	EFR7300
KNORR	K000572	EFR7301	KNORR	K000852	EFR7301
KNORR	K000584	EFR6302	KNORR	K000852IV	EFR7301
KNORR	K000584AT	EFR6302	KNORR	K000870	EFR7302
KNORR	K000585	EFR6303	KNORR	K000871	EFR7303
KNORR	K000585AT	EFR6303	KNORR	K000871AT	EFR7303
KNORR	K000605	EFR7310	KNORR	K000872	EFR7302
KNORR	K000606	EFR7311	KNORR	K000872SX	EFR7302
KNORR	K000696	CAC010	KNORR	K000873	EFR7303
KNORR	K000715	EFR6301	KNORR	K000873SX	EFR7303
KNORR	K000716	EFR6300	KNORR	K000878	EFR6313
KNORR	K000719	EFR7302	KNORR	K000879	EFR6312
KNORR	K000719AT	EFR7302	KNORR	K000937	98028800
KNORR	K000720	EFR7303	KNORR	K000937	W0360SA
KNORR	K000720AT	EFR7303	KNORR	K000937	W0760BP
KNORR	K000771	EFR7304	KNORR	K000938	98028800
KNORR	K000772	EFR7305	KNORR	K000938	W0360SA
KNORR	K000773	EFR7304	KNORR	K000944	CAC008
KNORR	K000774	EFR7305	KNORR	K000993	EFR7344
KNORR	K000778	EFR7305	KNORR	K000994	EFR7345
KNORR	K000779	EFR7304	KNORR	K001007	EFR7310
KNORR	K000780	EFR7302	KNORR	K001008	EFR7311

Les correspondances de références ont pour seul objectif d'aider la recherche de référence

Cross references are there for the sole purpose of helping the reference search

CORRESPONDANCES DES REFERENCES CROSS REFERENCE LIST

MARQUE/MAKER	REF/PN OES	REF/PN	MARQUE/MAKER	REF/PN OES	REF/PN
KNORR	K001009	EFR7310	KNORR	K001142SX	EFR7300
KNORR	K001010	EFR7311	KNORR	K001143	EFR7301
KNORR	K001038	EFR7300	KNORR	K001143SX	EFR7301
KNORR	K001039	EFR7301	KNORR	K001164	EFR7310
KNORR	K001051	EFR7302	KNORR	K001164AT	EFR7310
KNORR	K001051AT	EFR7302	KNORR	K001165	EFR7311
KNORR	K001051SX	EFR7302	KNORR	K001165AT	EFR7311
KNORR	K001052	EFR7303	KNORR	K001169	EFR7302
KNORR	K001052AT	EFR7303	KNORR	K001170	EFR7303
KNORR	K001052SX	EFR7303	KNORR	K001175	EFR6306
KNORR	K001054	EFR6300	KNORR	K001176	EFR6307
KNORR	K001055	EFR6301	KNORR	K001177	EFR6305
KNORR	K001077	EFR7310	KNORR	K001177DC	EFR6305
KNORR	K001078	EFR7311	KNORR	K001178	EFR6306
KNORR	K001079	EFR6300	KNORR	K001178DC	EFR6304
KNORR	K001079DC	EFR6300	KNORR	K001216	EFR7304
KNORR	K001080	EFR6301	KNORR	K001216DC	EFR7304
KNORR	K001080DC	EFR6301	KNORR	K001217	EFR7305
KNORR	K001081	EFR6300	KNORR	K001217DC	EFR7305
KNORR	K001081SX	EFR6300	KNORR	K001228	EFR7316
KNORR	K001082	EFR6301	KNORR	K001229	EFR7317
KNORR	K001082SX	EFR6301	KNORR	K001232	EFR7310
KNORR	K001083	EFR6300	KNORR	K001233	EFR7311
KNORR	K001084	EFR6301	KNORR	K001280	CAC007
KNORR	K001085	EFR6300	KNORR	K001289	EFR7302
KNORR	K001086	EFR6301	KNORR	K001290	EFR7303
KNORR	K001087	EFR6300	KNORR	K001291	EFR7300
KNORR	K001088	EFR6301	KNORR	K001292	EFR7301
KNORR	K001089	EFR6300	KNORR	K001300	CAC009
KNORR	K001090	EFR6301	KNORR	K001312	EFR7326
KNORR	K001091	EFR6300	KNORR	K001313	EFR7327
KNORR	K001092	EFR6301	KNORR	K001314	EFR7326
KNORR	K001093	EFR6300	KNORR	K001315	EFR7327
KNORR	K001094	EFR6301	KNORR	K001316	EFR7344
KNORR	K001104	2920200604	KNORR	K001317	EFR7345
KNORR	K001104	2924401	KNORR	K001336	EFR7308
KNORR	K001104	2927801	KNORR	K001337	EFR7309
KNORR	K001104	CVP020K	KNORR	K001338	EFR6300
KNORR	K001104	FCV4418PTS	KNORR	K001339	EFR6301
KNORR	K001115	EFR7300	KNORR	K001340	EFR6300
KNORR	K001116	EFR7301	KNORR	K001341	EFR6301
KNORR	K001117	EFR6300	KNORR	K001352	EFR7308
KNORR	K001117SX	EFR6300	KNORR	K001353	EFR7309
KNORR	K001118	EFR6301	KNORR	K001356	EFR7308
KNORR	K001118SX	EFR6301	KNORR	K001357	EFR7309
KNORR	K001140	EFR7300	KNORR	K001358	EFR7304
KNORR	K001141	EFR7301	KNORR	K001359	EFR7305
KNORR	K001142	EFR7300	KNORR	K001360	EFR7304

Les correspondances de références ont pour seul objectif d'aider la recherche de référence

Cross references are there for the sole purpose of helping the reference search

CORRESPONDANCES DES REFERENCES CROSS REFERENCE LIST

MARQUE/MAKER	REF/PN OES	REF/PN	MARQUE/MAKER	REF/PN OES	REF/PN
KNORR	K001361	EFR7305	KNORR	K001590SC	EFR7334
KNORR	K001362	EFR7304	KNORR	K001591	EFR7306
KNORR	K001362AT	EFR7304	KNORR	K001591SC	EFR7306
KNORR	K001363	EFR7305	KNORR	K001592	EFR7307
KNORR	K001363AT	EFR7305	KNORR	K001592SC	EFR7307
KNORR	K001364	EFR7304	KNORR	K001593	EFR7306
KNORR	K001364AT	EFR7304	KNORR	K001594	EFR7307
KNORR	K001365	EFR7305	KNORR	K001654	EFR7320
KNORR	K001365AT	EFR7305	KNORR	K001654SC	EFR7320
KNORR	K001370	EFR7300	KNORR	K001655	EFR7321
KNORR	K001371	EFR7301	KNORR	K001655SC	EFR7321
KNORR	K001372	EFR7302	KNORR	K001659	EFR7302
KNORR	K001373	EFR7303	KNORR	K001659SC	EFR7302
KNORR	K001374	EFR7302	KNORR	K001660	EFR7303
KNORR	K001375	EFR7303	KNORR	K001660SC	EFR7303
KNORR	K001413	EFR7300	KNORR	K001661	EFR7302
KNORR	K001414	EFR7301	KNORR	K001662	EFR7303
KNORR	K001419	EFR7304	KNORR	K001747	EFR5301
KNORR	K001420	EFR7305	KNORR	K001747DC	EFR5301
KNORR	K001421	EFR7304	KNORR	K001748	EFR5300
KNORR	K001422	EFR7305	KNORR	K001748DC	EFR5300
KNORR	K001440	EFR6300	KNORR	K001749	EFR5301
KNORR	K001441	EFR6301	KNORR	K001750	EFR5300
KNORR	K001442	EFR6300	KNORR	K001751	EFR5303
KNORR	K001442SX	EFR6300	KNORR	K001751DC	EFR5303
KNORR	K001443	EFR6301	KNORR	K001752	EFR5302
KNORR	K001443SX	EFR6301	KNORR	K001752DC	EFR5302
KNORR	K001444	EFR6300	KNORR	K001753	EFR5303
KNORR	K001444SX	EFR6300	KNORR	K001754	EFR5302
KNORR	K001445	EFR6301	KNORR	K001763	EFR6307
KNORR	K001445SX	EFR6301	KNORR	K001764	EFR6306
KNORR	K001451	EFR7302	KNORR	K001765	EFR6307
KNORR	K001451SX	EFR7302	KNORR	K001766	EFR6306
KNORR	K001452	EFR7303	KNORR	K001767	EFR6304
KNORR	K001452SX	EFR7303	KNORR	K001768	EFR6305
KNORR	K001460	EFR7302	KNORR	K001769	EFR6304
KNORR	K001461	EFR7303	KNORR	K001770	EFR6305
KNORR	K001475	EFR7304	KNORR	K001896	EFR7308
KNORR	K001476	EFR7305	KNORR	K001897	EFR7309
KNORR	K001481	EFR6308	KNORR	K001908	EFR6308
KNORR	K001482	EFR6309	KNORR	K001909	EFR6309
KNORR	K001532	CAC010	KNORR	K001915	CAC025
KNORR	K001537	2918302	KNORR	K001921	2933100604
KNORR	K001545	EFR6300	KNORR	K001921	2933101
KNORR	K001546	EFR6301	KNORR	K001925	CAC025
KNORR	K001589	EFR7335	KNORR	K001942	EFR5304
KNORR	K001589SC	EFR7335	KNORR	K001943	EFR5305
KNORR	K001590	EFR7334	KNORR	K001944	EFR5304

Les correspondances de références ont pour seul objectif d'aider la recherche de référence

Cross references are there for the sole purpose of helping the reference search

CORRESPONDANCES DES REFERENCES CROSS REFERENCE LIST

MARQUE/MAKER	REF/PN OES	REF/PN	MARQUE/MAKER	REF/PN OES	REF/PN
KNORR	K001945	EFR5305	KNORR	K002167SX	EFR7300
KNORR	K001949	EFR7314	KNORR	K002168	EFR7301
KNORR	K001950	EFR7315	KNORR	K002168SX	EFR7301
KNORR	K001951	EFR7302	KNORR	K002222	EFR7302
KNORR	K001952	EFR7303	KNORR	K002223	EFR7303
KNORR	K001953	EFR7300	KNORR	K002242	2932002
KNORR	K001954	EFR7301	KNORR	K002242	2932004
KNORR	K001955	EFR6300	KNORR	K002246	EFR7302
KNORR	K001956	EFR6301	KNORR	K002247	EFR7303
KNORR	K001957	EFR7336	KNORR	K002306	EFR7302
KNORR	K001958	EFR7337	KNORR	K002307	EFR7303
KNORR	K002010	EFR7302	KNORR	K002337	EFR7304
KNORR	K002011	EFR7303	KNORR	K002338	EFR7305
KNORR	K002012	EFR7315	KNORR	K002339	EFR7304
KNORR	K002012AT	EFR7314	KNORR	K002340	EFR7305
KNORR	K002013	EFR7314	KNORR	K002341	EFR7300
KNORR	K002013AT	EFR7315	KNORR	K002342	EFR7301
KNORR	K002057	EFR7302	KNORR	K002343	EFR7300
KNORR	K002058	EFR7303	KNORR	K002344	EFR7301
KNORR	K002059	EFR6306	KNORR	K002345	EFR7304
KNORR	K002059DC	EFR6307	KNORR	K002346	EFR7305
KNORR	K002060	EFR6307	KNORR	K002347	EFR7304
KNORR	K002060DC	EFR6306	KNORR	K002348	EFR7305
KNORR	K002061	EFR6306	KNORR	K002349	EFR7304
KNORR	K002062	EFR6307	KNORR	K002350	EFR7305
KNORR	K002063	EFR6304	KNORR	K002351	EFR7304
KNORR	K002063DC	EFR6304	KNORR	K002352	EFR7305
KNORR	K002064	EFR6305	KNORR	K002353	EFR7304
KNORR	K002064DC	EFR6305	KNORR	K002354	EFR7305
KNORR	K002065	EFR6304	KNORR	K002355	EFR7304
KNORR	K002066	EFR6305	KNORR	K002355DC	EFR7304
KNORR	K002099	EFR7310	KNORR	K002356	EFR7305
KNORR	K002100	EFR7311	KNORR	K002356DC	EFR7305
KNORR	K002107	EFR6313	KNORR	K002357	EFR7300
KNORR	K002108	EFR6312	KNORR	K002358	EFR7301
KNORR	K002118	EFR7300	KNORR	K002359	EFR7300
KNORR	K002118SX	EFR7300	KNORR	K002360	EFR7301
KNORR	K002119	EFR7301	KNORR	K002361	EFR7304
KNORR	K002119SX	EFR7301	KNORR	K002362	EFR7305
KNORR	K002142	EFR6300	KNORR	K002363	EFR7304
KNORR	K002142AT	EFR6300	KNORR	K002363DC	EFR7304
KNORR	K002143	EFR6301	KNORR	K002364	EFR7305
KNORR	K002143AT	EFR6301	KNORR	K002364DC	EFR7305
KNORR	K002144	EFR7300	KNORR	K002375	EFR7300
KNORR	K002144SX	EFR7300	KNORR	K002376	EFR7301
KNORR	K002145	EFR7301	KNORR	K002409	2918302
KNORR	K002145SX	EFR7301	KNORR	K002444	EFR7308
KNORR	K002167	EFR7300	KNORR	K002444AT	EFR7328

Les correspondances de références ont pour seul objectif d'aider la recherche de référence

Cross references are there for the sole purpose of helping the reference search

CORRESPONDANCES DES REFERENCES CROSS REFERENCE LIST

MARQUE/MAKER	REF/PN OES	REF/PN	MARQUE/MAKER	REF/PN OES	REF/PN
KNORR	K002445	EFR7309	KNORR	K002915	EFR6301
KNORR	K002445AT	EFR7329	KNORR	K002916	EFR6300
KNORR	K002446	EFR7308	KNORR	K002919	EFR6311
KNORR	K002446AT	EFR7308	KNORR	K002920	EFR6310
KNORR	K002447	EFR7309	KNORR	K002923	EFR6302
KNORR	K002447AT	EFR7309	KNORR	K002923K64	EFR6302
KNORR	K002515	EFR6300	KNORR	K002924	EFR6303
KNORR	K002516	EFR6301	KNORR	K002924K64	EFR6303
KNORR	K002517	EFR7302	KNORR	K002934	EFR6300
KNORR	K002518	EFR7303	KNORR	K002935	EFR6301
KNORR	K002519	EFR5303	KNORR	K002962	EFR7315
KNORR	K002520	EFR5302	KNORR	K002963	EFR7314
KNORR	K002522	EFR7300	KNORR	K002964	EFR7317
KNORR	K002523	EFR7301	KNORR	K002965	EFR7316
KNORR	K002561	EFR7305	KNORR	K002966	EFR7307
KNORR	K002562	EFR7304	KNORR	K002967	EFR7306
KNORR	K002571	EFR7310	KNORR	K002968	EFR7325
KNORR	K002572	EFR7311	KNORR	K002969	EFR7324
KNORR	K002575	EFR7326	KNORR	K002983	EFR7310
KNORR	K002576	EFR7327	KNORR	K002984	EFR7311
KNORR	K002654	EFR6300	KNORR	K003056	EFR6300
KNORR	K002655	EFR6301	KNORR	K003057	EFR6301
KNORR	K002658	EFR7302	KNORR	K003192	EFR7325
KNORR	K002659	EFR7303	KNORR	K003193	EFR7324
KNORR	K002660	EFR7302	KNORR	K003249AT	EFR7310
KNORR	K002661	EFR7303	KNORR	K003250AT	EFR7311
KNORR	K002708	EFR7301	KNORR	K003301	EFR5300
KNORR	K002709	EFR7300	KNORR	K003302	EFR5301
KNORR	K002716	CAC025	KNORR	K003312	EFR7300
KNORR	K002717	2932002	KNORR	K003313	EFR7301
KNORR	K002759	EFR7311	KNORR	K003346	EFR7304
KNORR	K002760	EFR7310	KNORR	K003347	EFR7305
KNORR	K002783	EFR7311	KNORR	K003348	EFR7304
KNORR	K002784	EFR7310	KNORR	K003349	EFR7305
KNORR	K002785	EFR7303	KNORR	K003350	EFR7304
KNORR	K002786	EFR7302	KNORR	K003350AT	EFR7304
KNORR	K002793	EFR7301	KNORR	K003351	EFR7305
KNORR	K002794	EFR7300	KNORR	K003351AT	EFR7305
KNORR	K002797	EFR7313	KNORR	K003352	EFR7304
KNORR	K002798	EFR7312	KNORR	K003353	EFR7305
KNORR	K002837	CAC008	KNORR	K003386	EFR7311
KNORR	K002845	CAC007	KNORR	K003387	EFR7310
KNORR	K002846	CAC009	KNORR	K003400	EFR6308
KNORR	K002872	CAC026	KNORR	K003401	EFR6309
KNORR	K002874	EFR6301	KNORR	K003402	EFR6308
KNORR	K002875	EFR6300	KNORR	K003403	EFR6309
KNORR	K002878	EFR6301	KNORR	K003453	EFR6308
KNORR	K002879	EFR6300	KNORR	K003454	EFR6309

Les correspondances de références ont pour seul objectif d'aider la recherche de référence

Cross references are there for the sole purpose of helping the reference search

CORRESPONDANCES DES REFERENCES CROSS REFERENCE LIST

MARQUE/MAKER	REF/PN OES	REF/PN	MARQUE/MAKER	REF/PN OES	REF/PN
KNORR	K003455	EFR7314	KNORR	K003797	EFR7305
KNORR	K003456	EFR7315	KNORR	K003798	EFR7304
KNORR	K003662	EFR6300	KNORR	K003799	EFR7305
KNORR	K003662AT	EFR6300	KNORR	K003800	EFR7304
KNORR	K003663	EFR6301	KNORR	K003801	EFR7304
KNORR	K003663AT	EFR6301	KNORR	K003802	EFR7305
KNORR	K003664	EFR7302	KNORR	K003803	EFR7303
KNORR	K003665	EFR7303	KNORR	K003804	EFR7302
KNORR	K003666	EFR7302	KNORR	K003805	EFR7309
KNORR	K003667	EFR7303	KNORR	K003806	EFR7308
KNORR	K003668	EFR6302	KNORR	K003807	EFR7329
KNORR	K003669	EFR6303	KNORR	K003808	EFR7328
KNORR	K003670	EFR7302	KNORR	K003809	EFR7311
KNORR	K003671	EFR7303	KNORR	K003810	EFR7310
KNORR	K003672	EFR6300	KNORR	K003811	EFR7311
KNORR	K003673	EFR6301	KNORR	K003812	EFR7310
KNORR	K003702	EFR7306	KNORR	K003813	EFR7321
KNORR	K003703	EFR7307	KNORR	K003814	EFR7320
KNORR	K003715	EFR6306	KNORR	K003815	EFR7331
KNORR	K003715DC	EFR6306	KNORR	K003816	EFR7330
KNORR	K003716	EFR6307	KNORR	K003825	EFR6301
KNORR	K003716DC	EFR6307	KNORR	K003826	EFR6300
KNORR	K003717	EFR6305	KNORR	K003827	EFR6307
KNORR	K003717DC	EFR6305	KNORR	K003828	EFR6306
KNORR	K003718	EFR6304	KNORR	K003830	EFR7344
KNORR	K003718DC	EFR6304	KNORR	K003831	EFR7345
KNORR	K003779	EFR6301	KNORR	K003849	EFR7315
KNORR	K003780	EFR6300	KNORR	K003850	EFR7314
KNORR	K003781	EFR7301	KNORR	K003852	EFR7302
KNORR	K003782	EFR7300	KNORR	K003852SC	EFR7302
KNORR	K003783	EFR7303	KNORR	K003853	EFR7303
KNORR	K003783K64	EFR7303	KNORR	K003853SC	EFR7303
KNORR	K003784	EFR7302	KNORR	K003856	EFR6317
KNORR	K003784K64	EFR7302	KNORR	K003857	EFR6316
KNORR	K003785	EFR7303	KNORR	K003860	EFR7316
KNORR	K003786	EFR7302	KNORR	K003861	EFR7317
KNORR	K003787	EFR7311	KNORR	K004100	CAC026
KNORR	K003787K64	EFR7311	KNORR	K004161	EFR6300
KNORR	K003788	EFR7310	KNORR	K004161SX	EFR6300
KNORR	K003788K64	EFR7310	KNORR	K004162	EFR6301
KNORR	K003789	EFR6313	KNORR	K004162SX	EFR6301
KNORR	K003790	EFR6312	KNORR	K004168	CAC026
KNORR	K003791	EFR6305	KNORR	K004169K50	2925705390
KNORR	K003792	EFR6304	KNORR	K004169K50	2926900604
KNORR	K003793	EFR6306	KNORR	K004169K50	2926901
KNORR	K003794	EFR6307	KNORR	K004169K64	2926900604
KNORR	K003795	EFR7301	KNORR	K004169K64	2926901
KNORR	K003796	EFR7300	KNORR	K004198	2925305390

Les correspondances de références ont pour seul objectif d'aider la recherche de référence

Cross references are there for the sole purpose of helping the reference search

CORRESPONDANCES DES REFERENCES CROSS REFERENCE LIST

MARQUE/MAKER	REF/PN OES	REF/PN	MARQUE/MAKER	REF/PN OES	REF/PN
KNORR	K004198	2927802	KNORR	K005038	EFR7345
KNORR	K004198	CVP020K	KNORR	K005077	EFR7320
KNORR	K004276	EFR7304	KNORR	K005078	EFR7321
KNORR	K004277	EFR7305	KNORR	K005079	EFR7302
KNORR	K004278	EFR7304	KNORR	K005080	EFR7303
KNORR	K004279	EFR7305	KNORR	K005481	EFR7314
KNORR	K004322	93145600	KNORR	K005482	EFR7315
KNORR	K004322	DF70004+	KNORR	K005504	EFR7303
KNORR	K004322	FCR225A	KNORR	K005505	EFR7302
KNORR	K004481	EFR6300	KNORR	K005594	09.8574.10
KNORR	K004482	EFR6301	KNORR	K005594	93101300
KNORR	K004483	EFR6300	KNORR	K005594	FCR186A
KNORR	K004484	EFR6301	KNORR	K005610	EFR5304
KNORR	K004496	EFR7302	KNORR	K005611	EFR5305
KNORR	K004497	EFR7303	KNORR	K005713	EFR7312
KNORR	K004526	EFR6300	KNORR	K005714	EFR7313
KNORR	K004527	EFR6301	KNORR	K005757	EFR7302
KNORR	K004545	EFR7336	KNORR	K005758	EFR7303
KNORR	K004546	EFR7337	KNORR	K005759	EFR7302
KNORR	K004547	EFR7302	KNORR	K005760	EFR7303
KNORR	K004548	EFR7303	KNORR	K005938	09.8793.10
KNORR	K004549	EFR7344	KNORR	K005938	93101800
KNORR	K004550	EFR7345	KNORR	K005938	FCR201A
KNORR	K004570	EFR5301	KNORR	K005968	EFR6314
KNORR	K004571	EFR5300	KNORR	K005969	EFR6315
KNORR	K004572	EFR5303	KNORR	K005970	EFR6314
KNORR	K004573	EFR5302	KNORR	K005971	EFR6315
KNORR	K004578	EFR7301	KNORR	K006430	EFR7328
KNORR	K004579	EFR7300	KNORR	K006430AT	EFR7328
KNORR	K004580	EFR7305	KNORR	K006431	EFR7329
KNORR	K004581	EFR7304	KNORR	K006431AT	EFR7329
KNORR	K004623	EFR7333	KNORR	K006432	EFR7308
KNORR	K004624	EFR7332	KNORR	K006432AT	EFR7308
KNORR	K004625	EFR7300	KNORR	K006433	EFR7309
KNORR	K004626	EFR7301	KNORR	K006433AT	EFR7309
KNORR	K004674	EFR6308	KNORR	K006539	EFR7323
KNORR	K004675	EFR6309	KNORR	K006540	EFR7322
KNORR	K004733	EFR5302	KNORR	K006605	EFR7302
KNORR	K004734	EFR5303	KNORR	K006606	EFR7303
KNORR	K004758	EFR6301	KNORR	K006843	EFR6300
KNORR	K004759	EFR6301	KNORR	K006844	EFR6301
KNORR	K004804	EFR7336	KNORR	K006872	EFR7300
KNORR	K004805	EFR7337	KNORR	K006873	EFR7301
KNORR	K004854	EFR7302	KNORR	K007088	EFR7304
KNORR	K004855	EFR7303	KNORR	K007089	EFR7305
KNORR	K005020	EFR7302	KNORR	K007090	EFR7304
KNORR	K005021	EFR7303	KNORR	K007090DC	EFR7304
KNORR	K005037	EFR7344	KNORR	K007091	EFR7305

Les correspondances de références ont pour seul objectif d'aider la recherche de référence

Cross references are there for the sole purpose of helping the reference search

CORRESPONDANCES DES REFERENCES CROSS REFERENCE LIST

MARQUE/MAKER	REF/PN OES	REF/PN	MARQUE/MAKER	REF/PN OES	REF/PN
KNORR	K007091DC	EFR7305	KNORR	K008653	EFR7335
KNORR	K007092	EFR7304	KNORR	K008654	EFR7334
KNORR	K007093	EFR7305	KNORR	K009083	EFR7320
KNORR	K007094	EFR7304	KNORR	K009084	EFR7321
KNORR	K007095	EFR7305	KNORR	K009085	EFR7302
KNORR	K007096	EFR7304	KNORR	K009086	EFR7303
KNORR	K007097	EFR7305	KNORR	K009087	EFR7302
KNORR	K007098	EFR7304	KNORR	K009088	EFR7303
KNORR	K007098DC	EFR7304	KNORR	K009161	EFR6315
KNORR	K007099	EFR7305	KNORR	K009162	EFR6314
KNORR	K007099DC	EFR7305	KNORR	K009173	EFR6300
KNORR	K007151	EFR7304	KNORR	K009174	EFR6301
KNORR	K007152	EFR7305	KNORR	K009258	EFR7302
KNORR	K007153	EFR7304	KNORR	K009259	EFR7303
KNORR	K007154	EFR7305	KNORR	K009277	EFR7302
KNORR	K007155	EFR7304	KNORR	K009278	EFR7303
KNORR	K007156	EFR7305	KNORR	K009279	EFR7302
KNORR	K007159	EFR7304	KNORR	K009280	EFR7303
KNORR	K007160	EFR7305	KNORR	K009281	EFR7302
KNORR	K007187	EFR7304	KNORR	K009282	EFR7303
KNORR	K007188	EFR7305	KNORR	K009283	EFR7302
KNORR	K007189	EFR7304	KNORR	K009284	EFR7303
KNORR	K007190	EFR7305	KNORR	K009744	EFR6308
KNORR	K007197	CAC009	KNORR	K009745	EFR6309
KNORR	K007243	2920200604	KNORR	K009746	EFR6308
KNORR	K007243	2924401	KNORR	K009747	EFR6309
KNORR	K007243	2927801	KNORR	K009839	2918302
KNORR	K007243	FCV4418PTS	KNORR	K009883	EFR6306
KNORR	K007765	EFR7300	KNORR	K009883DC	EFR6307
KNORR	K007766	EFR7301	KNORR	K009884	EFR6307
KNORR	K007767	EFR7333	KNORR	K009884DC	EFR6306
KNORR	K007767IV	EFR7333	KNORR	K009897	EFR7335
KNORR	K007768	EFR7332	KNORR	K009897SC	EFR7335
KNORR	K007768IV	EFR7332	KNORR	K009898	EFR7334
KNORR	K008168	EFR7304	KNORR	K009898SC	EFR7334
KNORR	K008169	EFR7305	KNORR	K009899	EFR7335
KNORR	K008170	EFR7304	KNORR	K009900	EFR7334
KNORR	K008171	EFR7305	KNORR	K009901	EFR7306
KNORR	K008172	EFR7304	KNORR	K009902	EFR7307
KNORR	K008172DC	EFR7304	KNORR	K009903	EFR7306
KNORR	K008173	EFR7305	KNORR	K009903SC	EFR7306
KNORR	K008173DC	EFR7305	KNORR	K009904	EFR7307
KNORR	K008415	EFR7314	KNORR	K009904SC	EFR7307
KNORR	K008416	EFR7315	KNORR	K009910	EFR6306
KNORR	K008649	EFR7306	KNORR	K009911	EFR6307
KNORR	K008650	EFR7307	KNORR	K009912	EFR6304
KNORR	K008651	EFR7306	KNORR	K009913	EFR6305
KNORR	K008652	EFR7307	KNORR	K009914	EFR6304

Les correspondances de références ont pour seul objectif d'aider la recherche de référence

Cross references are there for the sole purpose of helping the reference search

CORRESPONDANCES DES REFERENCES CROSS REFERENCE LIST

MARQUE/MAKER	REF/PN OES	REF/PN	MARQUE/MAKER	REF/PN OES	REF/PN
KNORR	K009914DC	EFR6304	KNORR	K010627	EFR7336
KNORR	K009915	EFR6305	KNORR	K010650	EFR7316
KNORR	K009915DC	EFR6305	KNORR	K010651	EFR7317
KNORR	K009965	EFR7300	KNORR	K010652	EFR7314
KNORR	K009966	EFR7301	KNORR	K010653	EFR7315
KNORR	K010053	EFR7322	KNORR	K010654	EFR7316
KNORR	K010054	EFR7323	KNORR	K010655	EFR7317
KNORR	K010114	EFR7302	KNORR	K010656	EFR7323
KNORR	K010115	EFR7303	KNORR	K010657	EFR7322
KNORR	K010147	EFR7304	KNORR	K010658	EFR7314
KNORR	K010148	EFR7305	KNORR	K010658AT	EFR7314
KNORR	K010149	EFR7304	KNORR	K010659	EFR7315
KNORR	K010150	EFR7305	KNORR	K010659AT	EFR7315
KNORR	K010151	EFR7304	KNORR	K010694	EFR5303
KNORR	K010152	EFR7305	KNORR	K010695	EFR5302
KNORR	K010153	EFR7344	KNORR	K010743	EFR7303
KNORR	K010154	EFR7345	KNORR	K010744	EFR7302
KNORR	K010155	EFR7321	KNORR	K010749	EFR7310
KNORR	K010155SC	EFR7321	KNORR	K010750	EFR7311
KNORR	K010156	EFR7320	KNORR	K010766	CAC026
KNORR	K010156SC	EFR7320	KNORR	K010766K62	CAC026
KNORR	K010164	EFR7314	KNORR	K010766K64	CAC026
KNORR	K010165	EFR7315	KNORR	K010791	EFR5303
KNORR	K010166	EFR7315	KNORR	K010792	EFR5302
KNORR	K010166AT	EFR7314	KNORR	K010793	EFR5301
KNORR	K010167	EFR7314	KNORR	K010794	EFR5300
KNORR	K010167AT	EFR7315	KNORR	K010809	EFR7334
KNORR	K010168	EFR7314	KNORR	K010810	EFR7335
KNORR	K010169	EFR7315	KNORR	K010897	EFR7304
KNORR	K010170	EFR7316	KNORR	K010898	EFR7305
KNORR	K010171	EFR7317	KNORR	K010899	EFR7304
KNORR	K010172	EFR7316	KNORR	K010900	EFR7305
KNORR	K010173	EFR7317	KNORR	K010901	EFR7304
KNORR	K010277	EFR6308	KNORR	K010902	EFR7305
KNORR	K010277DC	EFR6308	KNORR	K011130	EFR7304
KNORR	K010278	EFR6309	KNORR	K011131	EFR7305
KNORR	K010278DC	EFR6309	KNORR	K011132	EFR7304
KNORR	K010279	EFR6308	KNORR	K011133	EFR7305
KNORR	K010280	EFR6309	KNORR	K011134	EFR7304
KNORR	K010281	EFR6308	KNORR	K011135	EFR7305
KNORR	K010282	EFR6309	KNORR	K011136	EFR7304
KNORR	K010283	EFR6308	KNORR	K011137	EFR7305
KNORR	K010284	EFR6309	KNORR	K011138	EFR7310
KNORR	K010603	CAC009	KNORR	K011139	EFR7311
KNORR	K010603K62	CAC009	KNORR	K011140	EFR7310
KNORR	K010604	CAC008	KNORR	K011141	EFR7311
KNORR	K010604K62	CAC008	KNORR	K011170	EFR7302
KNORR	K010626	EFR7337	KNORR	K011171	EFR7303

Les correspondances de références ont pour seul objectif d'aider la recherche de référence

Cross references are there for the sole purpose of helping the reference search

CORRESPONDANCES DES REFERENCES CROSS REFERENCE LIST

MARQUE/MAKER	REF/PN OES	REF/PN	MARQUE/MAKER	REF/PN OES	REF/PN
KNORR	K011172	EFR7302	KNORR	K011367	EFR6308
KNORR	K011173	EFR7303	KNORR	K011368	EFR6309
KNORR	K011174	EFR7300	KNORR	K011391	EFR7308
KNORR	K011175	EFR7301	KNORR	K011392	EFR7309
KNORR	K011176	EFR7300	KNORR	K011470K50	2930701
KNORR	K011177	EFR7301	KNORR	K011470K50	CVP093K
KNORR	K011178	EFR5304	KNORR	K011471K50	2930801
KNORR	K011179	EFR5305	KNORR	K011471K50	CVP094K
KNORR	K011180	EFR5304	KNORR	K011537	EFR6306
KNORR	K011181	EFR5305	KNORR	K011538	EFR6307
KNORR	K011237	EFR5304	KNORR	K011539	EFR6300
KNORR	K011238	EFR5305	KNORR	K011540	EFR6301
KNORR	K011239	EFR5300	KNORR	K011541	EFR6300
KNORR	K011240	EFR5301	KNORR	K011542	EFR6301
KNORR	K011257	EFR5302	KNORR	K011545	EFR6308
KNORR	K011258	EFR5303	KNORR	K011546	EFR6309
KNORR	K011259	EFR5302	KNORR	K011547	EFR6308
KNORR	K011259DC	EFR5302	KNORR	K011548	EFR6309
KNORR	K011260	EFR5303	KNORR	K011549	EFR5300
KNORR	K011260DC	EFR5303	KNORR	K011550	EFR5301
KNORR	K011261	EFR5300	KNORR	K011666	EFR7302
KNORR	K011262	EFR5301	KNORR	K011667	EFR7303
KNORR	K011263	EFR5300	KNORR	K011668	EFR7310
KNORR	K011263DC	EFR5300	KNORR	K011669	EFR7311
KNORR	K011264	EFR5301	KNORR	K011670	EFR7310
KNORR	K011264DC	EFR5301	KNORR	K011670AT	EFR7310
KNORR	K011294	EFR7310	KNORR	K011671	EFR7311
KNORR	K011295	EFR7311	KNORR	K011671AT	EFR7311
KNORR	K011296	EFR7302	KNORR	K011672	EFR7300
KNORR	K011297	EFR7303	KNORR	K011673	EFR7301
KNORR	K011298	EFR7302	KNORR	K011700	EFR7308
KNORR	K011298AT	EFR7302	KNORR	K011701	EFR7309
KNORR	K011299	EFR7303	KNORR	K011702	EFR7304
KNORR	K011299AT	EFR7303	KNORR	K011703	EFR7305
KNORR	K011300	EFR7304	KNORR	K011704	EFR6300
KNORR	K011301	EFR7305	KNORR	K011705	EFR6301
KNORR	K011302	EFR7300	KNORR	K011796	EFR6314
KNORR	K011303	EFR7301	KNORR	K011797	EFR6315
KNORR	K011304	EFR7300	KNORR	K0118606K55	EFR7314
KNORR	K011304AT	EFR7300	KNORR	K011872	EFR7310
KNORR	K011305	EFR7301	KNORR	K011873	EFR7311
KNORR	K011305AT	EFR7301	KNORR	K012001	EFR7314
KNORR	K011309	EFR7300	KNORR	K012002	EFR7315
KNORR	K011310	EFR7301	KNORR	K012003	EFR7314
KNORR	K011311	EFR7314	KNORR	K012004	EFR7315
KNORR	K011312	EFR7315	KNORR	K012005	EFR7340
KNORR	K011365	EFR6308	KNORR	K012006	EFR7341
KNORR	K011366	EFR6309	KNORR	K012007	EFR7340

Les correspondances de références ont pour seul objectif d'aider la recherche de référence

Cross references are there for the sole purpose of helping the reference search

CORRESPONDANCES DES REFERENCES CROSS REFERENCE LIST

MARQUE/MAKER	REF/PN OES	REF/PN	MARQUE/MAKER	REF/PN OES	REF/PN
KNORR	K012008	EFR7341	KNORR	K013181K64	EFR7301
KNORR	K012009	EFR7308	KNORR	K013182	EFR7300
KNORR	K012010	EFR7309	KNORR	K013182K64	EFR7300
KNORR	K012276	EFR7323	KNORR	K013183	EFR7303
KNORR	K012276AT	EFR7323	KNORR	K013184	EFR7302
KNORR	K012276SC	EFR7323	KNORR	K013203	EFR6301
KNORR	K012277	EFR7322	KNORR	K013204	EFR6300
KNORR	K012277AT	EFR7322	KNORR	K013221	EFR6316
KNORR	K012277SC	EFR7322	KNORR	K013222	EFR6317
KNORR	K012278	EFR7314	KNORR	K013328	EFR7304
KNORR	K012278AT	EFR7314	KNORR	K013329	EFR7305
KNORR	K012278SC	EFR7314	KNORR	K013473	EFR5300
KNORR	K012279	EFR7315	KNORR	K013474	EFR5301
KNORR	K012279AT	EFR7315	KNORR	K013576	EFR6300
KNORR	K012279SC	EFR7315	KNORR	K013577	EFR6301
KNORR	K012341	EFR6308	KNORR	K013592	EFR7302
KNORR	K012342	EFR6309	KNORR	K013593	EFR7303
KNORR	K012343	EFR7302	KNORR	K013655	EFR6301
KNORR	K012344	EFR7303	KNORR	K013656	EFR6300
KNORR	K012345	EFR6300	KNORR	K013807	EFR7300
KNORR	K012346	EFR6301	KNORR	K013808	EFR7301
KNORR	K012633	EFR6308	KNORR	K013818	EFR6313
KNORR	K012633K64	EFR6308	KNORR	K013818IV	EFR6313
KNORR	K012633K69	EFR6308	KNORR	K013819	EFR6312
KNORR	K012634	EFR6309	KNORR	K013819IV	EFR6312
KNORR	K012634K64	EFR6309	KNORR	K013869	EFR6300
KNORR	K012634K69	EFR6309	KNORR	K013870	EFR6301
KNORR	K012731	EFR6306	KNORR	K013871	EFR6300
KNORR	K012732	EFR6307	KNORR	K013872	EFR6301
KNORR	K012733	EFR6305	KNORR	K013873	EFR6308
KNORR	K012734	EFR6304	KNORR	K013874	EFR6309
KNORR	K013152	EFR6300	KNORR	K013879	EFR7300
KNORR	K013153	EFR6301	KNORR	K013880	EFR7301
KNORR	K013154	EFR6300	KNORR	K013883	EFR7300
KNORR	K013155	EFR6301	KNORR	K013884	EFR7301
KNORR	K013160	EFR7332	KNORR	K013885	EFR7300
KNORR	K013161	EFR7333	KNORR	K013886	EFR7301
KNORR	K013173	EFR6301	KNORR	K013887	EFR7302
KNORR	K013173K64	EFR6301	KNORR	K013888	EFR7303
KNORR	K013173K69	EFR6301	KNORR	K013889	EFR7302
KNORR	K013174	EFR6300	KNORR	K013890	EFR7303
KNORR	K013174K64	EFR6300	KNORR	K013891	EFR7300
KNORR	K013174K69	EFR6300	KNORR	K013892	EFR7301
KNORR	K013175	EFR6305	KNORR	K014065	EFR7341
KNORR	K013176	EFR6304	KNORR	K014066	EFR7340
KNORR	K013177	EFR6306	KNORR	K014186	EFR7304
KNORR	K013178	EFR6307	KNORR	K014187	EFR7305
KNORR	K013181	EFR7301	KNORR	K014334	EFR7300

Les correspondances de références ont pour seul objectif d'aider la recherche de référence

Cross references are there for the sole purpose of helping the reference search

CORRESPONDANCES DES REFERENCES CROSS REFERENCE LIST

MARQUE/MAKER	REF/PN OES	REF/PN	MARQUE/MAKER	REF/PN OES	REF/PN
KNORR	K014335	EFR7301	KNORR	K015005	EFR7336
KNORR	K014336	EFR7300	KNORR	K015006	EFR7337
KNORR	K014337	EFR7301	KNORR	K015007	EFR7336
KNORR	K014338	EFR7300	KNORR	K015008	EFR7337
KNORR	K014339	EFR7301	KNORR	K015009	EFR7310
KNORR	K014344	EFR7302	KNORR	K015010	EFR7311
KNORR	K014345	EFR7303	KNORR	K015013	EFR7302
KNORR	K014513	EFR6300	KNORR	K015014	EFR7303
KNORR	K014514	EFR6301	KNORR	K015015	EFR7302
KNORR	K014522	EFR7336	KNORR	K015016	EFR7303
KNORR	K014523	EFR7337	KNORR	K015086	EFR6308
KNORR	K014597	2932002	KNORR	K015087	EFR6309
KNORR	K014651	EFR7304	KNORR	K015234	EFR7302
KNORR	K014652	EFR7305	KNORR	K015234AT	EFR7302
KNORR	K014653	EFR7304	KNORR	K015235	EFR7303
KNORR	K014653AT	EFR7304	KNORR	K015235AT	EFR7303
KNORR	K014654	EFR7305	KNORR	K015425	EFR7300
KNORR	K014654AT	EFR7305	KNORR	K015425DC	EFR7300
KNORR	K014655	EFR7300	KNORR	K015426	EFR7301
KNORR	K014655AT	EFR7300	KNORR	K015426DC	EFR7301
KNORR	K014656	EFR7301	KNORR	K015427	EFR7300
KNORR	K014656AT	EFR7301	KNORR	K015428	EFR7301
KNORR	K014935	EFR6300	KNORR	K015429	EFR7300
KNORR	K014936	EFR6301	KNORR	K015430	EFR7301
KNORR	K014937	EFR6300	KNORR	K015557	EFR7302
KNORR	K014938	EFR6301	KNORR	K015558	EFR7303
KNORR	K014939	EFR6300	KNORR	K015559	EFR7302
KNORR	K014940	EFR6301	KNORR	K015560	EFR7303
KNORR	K014941	EFR6300	KNORR	K015804	EFR6307
KNORR	K014942	EFR6301	KNORR	K015804DC	EFR6307
KNORR	K014987	EFR7310	KNORR	K015805	EFR6306
KNORR	K014988	EFR7311	KNORR	K015805DC	EFR6306
KNORR	K014989	EFR7310	KNORR	K015806	EFR6304
KNORR	K014990	EFR7311	KNORR	K015806DC	EFR6304
KNORR	K014991	EFR7310	KNORR	K015807	EFR6305
KNORR	K014992	EFR7311	KNORR	K015807DC	EFR6305
KNORR	K014993	EFR7302	KNORR	K015899	EFR6305
KNORR	K014994	EFR7303	KNORR	K015899DC	EFR6306
KNORR	K014995	EFR7302	KNORR	K015900	EFR6304
KNORR	K014996	EFR7303	KNORR	K015900DC	EFR6307
KNORR	K014997	EFR7310	KNORR	K015972	EFR5304
KNORR	K014998	EFR7311	KNORR	K015973	EFR5305
KNORR	K014999	EFR7326	KNORR	K016039K62	2926900604
KNORR	K015000	EFR7327	KNORR	K016039K62	2926901
KNORR	K015001	EFR7326	KNORR	K016382	2918302
KNORR	K015002	EFR7327	KNORR	K016515	EFR7303
KNORR	K015003	EFR7326	KNORR	K016516	EFR7302
KNORR	K015004	EFR7327	KNORR	K016524	EFR7342

Les correspondances de références ont pour seul objectif d'aider la recherche de référence

Cross references are there for the sole purpose of helping the reference search

CORRESPONDANCES DES REFERENCES CROSS REFERENCE LIST

MARQUE/MAKER	REF/PN OES	REF/PN	MARQUE/MAKER	REF/PN OES	REF/PN
KNORR	K016525	EFR7343	KNORR	K023210	EFR7314
KNORR	K016526	EFR7342	KNORR	K023211	EFR7315
KNORR	K016527	EFR7343	KNORR	K023248	EFR7346
KNORR	K016528	EFR7342	KNORR	K023249	EFR7347
KNORR	K016529	EFR7343	KNORR	K023278	EFR7348
KNORR	K016618	EFR5304	KNORR	K023279	EFR7349
KNORR	K016619	EFR5305	KNORR	K023366	EFR7348
KNORR	K016620	EFR5305	KNORR	K023367	EFR7349
KNORR	K016621	EFR5304	KNORR	K023558	EFR7304
KNORR	K016622	EFR5301	KNORR	K023559	EFR7305
KNORR	K016623	EFR5300	KNORR	K023627	EFR7314
KNORR	K016626	EFR5304	KNORR	K023628	EFR7315
KNORR	K016627	EFR5305	KNORR	K023629	EFR7300
KNORR	K016811	EFR7300	KNORR	K023630	EFR7301
KNORR	K016812	EFR7301	KNORR	K023735	EFR7300
KNORR	K016813	EFR7300	KNORR	K023736	EFR7301
KNORR	K016814	EFR7301	KNORR	K023796	EFR6308
KNORR	K016827	EFR7300	KNORR	K023797	EFR6309
KNORR	K016828	EFR7301	KNORR	K024731	EFR6304
KNORR	K016829	EFR7333	KNORR	K024732	EFR6305
KNORR	K016830	EFR7332	KNORR	K024733	EFR6304
KNORR	K017172	EFR6314	KNORR	K024734	EFR6305
KNORR	K017173	EFR6315	KNORR	K024735	EFR6307
KNORR	K017195	EFR7302	KNORR	K024736	EFR6306
KNORR	K017196	EFR7303	KNORR	K024737	EFR6307
KNORR	K017384	EFR7314	KNORR	K024738	EFR6306
KNORR	K017385	EFR7315	KNORR	K025626	EFR6313
KNORR	K017395	EFR7300	KNORR	K025627	EFR6312
KNORR	K017396	EFR7301	KNORR	K026763	EFR7343
KNORR	K017477	EFR7302	KNORR	K026764	EFR7342
KNORR	K017478	EFR7303	KNORR	K028024	EFR6308
KNORR	K017479	EFR7302	KNORR	K028025	EFR6309
KNORR	K017480	EFR7303	KNORR	K028143	EFR7336
KNORR	K017707	CAC025	KNORR	K028144	EFR7337
KNORR	K017811	EFR7353	KNORR	K028451	CAC025
KNORR	K017812	EFR7352	KNORR	K028455	EFR6307
KNORR	K019013	EFR6300	KNORR	K028455DC	EFR6307
KNORR	K019014	EFR6301	KNORR	K028456	EFR6306
KNORR	K019136	EFR7333	KNORR	K028456DC	EFR6306
KNORR	K019137	EFR7332	KNORR	K028457	EFR6307
KNORR	K019417	EFR7333	KNORR	K028457DC	EFR6307
KNORR	K019418	EFR7332	KNORR	K028458	EFR6305
KNORR	K019562	EFR7302	KNORR	K028458	EFR6306
KNORR	K019563	EFR7303	KNORR	K028458DC	EFR6306
KNORR	K019759	EFR7302	KNORR	K029446	EFR6313
KNORR	K019760	EFR7303	KNORR	K029447	EFR6312
KNORR	K021666	EFR6308	KNORR	K031426	EFR7320
KNORR	K021667	EFR6309	KNORR	K031427	EFR7321

Les correspondances de références ont pour seul objectif d'aider la recherche de référence

Cross references are there for the sole purpose of helping the reference search

CORRESPONDANCES DES REFERENCES CROSS REFERENCE LIST

MARQUE/MAKER	REF/PN OES	REF/PN	MARQUE/MAKER	REF/PN OES	REF/PN
KNORR	K031428	EFR7321	KNORR	K035471K51	2924601
KNORR	K031428K55	EFR7321	KNORR	K035471K51	FCV4417PTS
KNORR	K031429	EFR7320	KNORR	K035472K50	2924401
KNORR	K031429K55	EFR7320	KNORR	K035472K50	FCV4418PTS
KNORR	K031430	EFR7302	KNORR	K036294	EFR7304
KNORR	K031430K55	EFR7302	KNORR	K036294K51	EFR7304
KNORR	K031431	EFR7303	KNORR	K036295	EFR7305
KNORR	K031431K55	EFR7303	KNORR	K036295K51	EFR7305
KNORR	K031434	EFR7302	KNORR	K036798	EFR7310
KNORR	K031435	EFR7303	KNORR	K036799	EFR7311
KNORR	K031436	EFR7306	KNORR	K039361	EFR7336
KNORR	K031437	EFR7307	KNORR	K039362	EFR7337
KNORR	K031438	EFR7306	KNORR	K039468	EFR7321
KNORR	K031438K55	EFR7306	KNORR	K039469	EFR7320
KNORR	K031439	EFR7307	KNORR	K039470	EFR7302
KNORR	K031439K55	EFR7307	KNORR	K039471	EFR7303
KNORR	K031440	EFR7335	KNORR	K039472	EFR7320
KNORR	K031440K55	EFR7335	KNORR	K039473	EFR7321
KNORR	K031441	EFR7334	KNORR	K039474	EFR7321
KNORR	K031441K55	EFR7334	KNORR	K039475	EFR7320
KNORR	K031442	EFR7335	KNORR	K039476	EFR7302
KNORR	K031443	EFR7334	KNORR	K039477	EFR7303
KNORR	K031678	EFR7308	KNORR	K039478	EFR7302
KNORR	K031679	EFR7309	KNORR	K039479	EFR7303
KNORR	K031680	EFR7310	KNORR	K039480	EFR7302
KNORR	K031681	EFR7311	KNORR	K039481	EFR7303
KNORR	K031890K50	2927802	KNORR	K040054	EFR7335
KNORR	K031890K50	CVP020K	KNORR	K040055	EFR7334
KNORR	K031891K50	2920200604	KNORR	K040056	EFR7306
KNORR	K031891K50	2927801	KNORR	K040057	EFR7307
KNORR	K032543	EFR7323	KNORR	K040060	EFR7323
KNORR	K032543K55	EFR7323	KNORR	K040061	EFR7322
KNORR	K032544	EFR7322	KNORR	K040231K64	2926900604
KNORR	K032544K55	EFR7322	KNORR	K040231K64	2926901
KNORR	K032578	EFR6306	KNORR	K040756	EFR7314
KNORR	K032578DC	EFR6306	KNORR	K040757	EFR7315
KNORR	K032579	EFR6307	KNORR	K040911	EFR6306
KNORR	K032579DC	EFR6307	KNORR	K040912	EFR6307
KNORR	K032585	EFR6306	KNORR	K040913	EFR7300
KNORR	K032586	EFR6307	KNORR	K040914	EFR7301
KNORR	K034248K50	93145600	KNORR	K040915	EFR7333
KNORR	K034248K50	DF70004+	KNORR	K040916	EFR7332
KNORR	K034248K50	FCR225A	KNORR	K040940	EFR7307
KNORR	K034249K50	93145600	KNORR	K040940K50	EFR7307
KNORR	K034249K50	DF70004+	KNORR	K040941	EFR7306
KNORR	K034249K50	FCR225A	KNORR	K040941K50	EFR7306
KNORR	K035471K50	2924601	KNORR	K040943	EFR7322
KNORR	K035471K50	FCV4417PTS	KNORR	K040943K50	EFR7322

Les correspondances de références ont pour seul objectif d'aider la recherche de référence

Cross references are there for the sole purpose of helping the reference search

CORRESPONDANCES DES REFERENCES CROSS REFERENCE LIST

MARQUE/MAKER	REF/PN OES	REF/PN	MARQUE/MAKER	REF/PN OES	REF/PN
KNORR	K040944	EFR7323	KNORR	K046771K50	2925305390
KNORR	K040944K50	EFR7323	KNORR	K046771K50	2927801
KNORR	K040945	EFR7334	KNORR	K046771K50	2927802
KNORR	K040945K50	EFR7334	KNORR	K046771K50	2927804
KNORR	K040946	EFR7335	KNORR	K046771K50	2930701
KNORR	K040946K50	EFR7335	KNORR	K046771K50	CVP020K
KNORR	K040953	EFR7321	KNORR	K046771K50	CVP093K
KNORR	K040953K50	EFR7321	KNORR	K046772K50	2920200604
KNORR	K040954	EFR7320	KNORR	K046772K50	2927801
KNORR	K040954K50	EFR7320	KNORR	K046772K50	CVP020K
KNORR	K041389K50	EFR7303	KNORR	K046773K50	2924601
KNORR	K041390K50	EFR7302	KNORR	K046773K50	FCV4417PTS
KNORR	K041454	EFR7302	KNORR	K046774K50	2924401
KNORR	K041455	EFR7303	KNORR	K046774K50	FCV4418PTS
KNORR	K043656	EFR7335	KNORR	K046837	EFR7300
KNORR	K043657	EFR7334	KNORR	K046838	EFR7301
KNORR	K043662	EFR7335	KNORR	K046839	EFR7333
KNORR	K043663	EFR7334	KNORR	K046840	EFR7332
KNORR	K044399	EFR7346	KNORR	K047412	EFR7316
KNORR	K044400	EFR7347	KNORR	K047413	EFR7317
KNORR	K044401	EFR7350	KNORR	K047846	EFR6300
KNORR	K044402	EFR7351	KNORR	K047847	EFR6301
KNORR	K045318	EFR7320	KNORR	K047865K50	2920200604
KNORR	K045319	EFR7321	KNORR	K047865K50	2927802
KNORR	K045320	EFR7321	KNORR	K047865K50	2927804
KNORR	K045320K55	EFR7321	KNORR	K047865K50	CVP020K
KNORR	K045321	EFR7320	KNORR	K048157	EFR7300
KNORR	K045321K55	EFR7320	KNORR	K048158	EFR7301
KNORR	K045322	EFR7302	KNORR	K048389K50	CAC025
KNORR	K045322K55	EFR7302	KNORR	K048434K62	CAC024
KNORR	K045323	EFR7303	KNORR	K049075	EFR7340
KNORR	K045323K55	EFR7303	KNORR	K049075AT	EFR7340
KNORR	K045324	EFR7302	KNORR	K049076	EFR7341
KNORR	K045325	EFR7303	KNORR	K049076AT	EFR7341
KNORR	K045326	EFR7302	KNORR	K049574	EFR7300
KNORR	K045327	EFR7303	KNORR	K049575	EFR7301
KNORR	K045381	EFR7300	KNORR	K049577	EFR7300
KNORR	K045381AT	EFR7300	KNORR	K049578	EFR7301
KNORR	K045382	EFR7301	KNORR	K049583	EFR7300
KNORR	K045382AT	EFR7301	KNORR	K049584	EFR7301
KNORR	K045383	EFR7300	KNORR	K049585	EFR7300
KNORR	K045384	EFR7301	KNORR	K049586	EFR7301
KNORR	K046523K50	CAC043	KNORR	K049587	EFR7310
KNORR	K046528K50	EFR7353	KNORR	K049588	EFR7311
KNORR	K046528K51	EFR7353	KNORR	K049969	EFR7300
KNORR	K046529K50	EFR7352	KNORR	K049970	EFR7301
KNORR	K046529K51	EFR7352	KNORR	K049971	EFR7300
KNORR	K046771K50	2920200604	KNORR	K049972	EFR7301

Les correspondances de références ont pour seul objectif d'aider la recherche de référence

Cross references are there for the sole purpose of helping the reference search

CORRESPONDANCES DES REFERENCES CROSS REFERENCE LIST

MARQUE/MAKER	REF/PN OES	REF/PN	MARQUE/MAKER	REF/PN OES	REF/PN
KNORR	K049973	EFR7300	KNORR	K052050	EFR7345
KNORR	K049974	EFR7301	KNORR	K052380K50	EFR7346
KNORR	K049975	EFR7300	KNORR	K052380K51	EFR7346
KNORR	K049976	EFR7301	KNORR	K052381K50	EFR7347
KNORR	K050040	EFR7300	KNORR	K052381K51	EFR7347
KNORR	K050041	EFR7301	KNORR	K052382K50	EFR7350
KNORR	K050042	EFR7300	KNORR	K052382K51	EFR7350
KNORR	K050043	EFR7301	KNORR	K052383K50	EFR7351
KNORR	K050085	09.B072.10	KNORR	K052383K51	EFR7351
KNORR	K050085	93127100	KNORR	K052392K50	EFR7348
KNORR	K050085	FCR222A	KNORR	K052392K51	EFR7348
KNORR	K050086	09.8486.20	KNORR	K052393K50	EFR7349
KNORR	K050088	09.8925.10	KNORR	K052393K51	EFR7349
KNORR	K050088	93101500	KNORR	K053490	EFR7328
KNORR	K050088	FCR190A	KNORR	K053491	EFR7329
KNORR	K050090	93105600	KNORR	K054617K50	EFR7301
KNORR	K050090	FCR204A	KNORR	K054618K50	EFR7300
KNORR	K050091	09.9983.10	KNORR	K055202K64	2925705390
KNORR	K050091	93142900	KNORR	K055420K50	EFR6300
KNORR	K050091	DF70006	KNORR	K055421K50	EFR6301
KNORR	K050091	FCR254A	KNORR	K055492	EFR7342
KNORR	K050103	EFR7302	KNORR	K055493	EFR7343
KNORR	K050104	EFR7303	KNORR	K055525	EFR6308
KNORR	K050185	EFR7302	KNORR	K055526	EFR6309
KNORR	K050186	EFR7303	KNORR	K056447AT	EFR7316
KNORR	K050921	EFR6308	KNORR	K056448	EFR7317
KNORR	K050921N64	EFR6308	KNORR	K056448AT	EFR7317
KNORR	K050922	EFR6309	KNORR	K056758K50	2932001
KNORR	K050922N64	EFR6309	KNORR	K056758K50	2932003
KNORR	K051219	EFR6300	KNORR	K056758K50	2932004
KNORR	K051220	EFR6301	KNORR	K056761K50	2932005
KNORR	K051221	EFR7304	KNORR	K056761K50	CVP036K
KNORR	K051222	EFR7305	KNORR	K056850	EFR7304
KNORR	K051223	EFR7302	KNORR	K056851	EFR7305
KNORR	K051224	EFR7303	KNORR	K056852	EFR7304
KNORR	K051225	EFR7302	KNORR	K056853	EFR7305
KNORR	K051226	EFR7303	KNORR	K056933	EFR5301
KNORR	K051227	EFR7302	KNORR	K056934	EFR5300
KNORR	K051228	EFR7303	KNORR	K056956	EFR7304
KNORR	K051229	EFR7314	KNORR	K056957	EFR7305
KNORR	K051230	EFR7315	KNORR	K056960	EFR7304
KNORR	K051231	EFR7300	KNORR	K056961	EFR7305
KNORR	K051232	EFR7301	KNORR	K057511	EFR6300
KNORR	K051233	EFR7302	KNORR	K057512	EFR6301
KNORR	K051234	EFR7303	KNORR	K058679	EFR7344
KNORR	K051475	EFR6306	KNORR	K058680	EFR7345
KNORR	K051476	EFR6307	KNORR	K058681	EFR6306
KNORR	K052049	EFR7344	KNORR	K058682	EFR6307

Les correspondances de références ont pour seul objectif d'aider la recherche de référence

Cross references are there for the sole purpose of helping the reference search

CORRESPONDANCES DES REFERENCES CROSS REFERENCE LIST

MARQUE/MAKER	REF/PN OES	REF/PN	MARQUE/MAKER	REF/PN OES	REF/PN
KNORR	K059174	EFR7302	KNORR	K064547	EFR7300
KNORR	K059175	EFR7303	KNORR	K064548	EFR7301
KNORR	K059176	EFR7302	KNORR	K064549	EFR7300
KNORR	K059177	EFR7303	KNORR	K064549AT	EFR7300
KNORR	K059193	EFR6312	KNORR	K064550	EFR7301
KNORR	K059194	EFR6313	KNORR	K064550AT	EFR7301
KNORR	K059965K50	2920200604	KNORR	K064551	EFR7300
KNORR	K059965K50	2927802	KNORR	K064552	EFR7301
KNORR	K059965K50	CVP020K	KNORR	K064553	EFR7300
KNORR	K060019	EFR7302	KNORR	K064554	EFR7301
KNORR	K060020	EFR7303	KNORR	K064559	EFR7304
KNORR	K060273K50	2930601	KNORR	K064560	EFR7305
KNORR	K060813	EFR6308	KNORR	K064561	EFR7304
KNORR	K060814	EFR6309	KNORR	K064562	EFR7305
KNORR	K061592	EFR7316	KNORR	K064563	EFR7304
KNORR	K061593	EFR7317	KNORR	K064564	EFR7305
KNORR	K061594	EFR7304	KNORR	K064728	EFR7302
KNORR	K061595	EFR7305	KNORR	K064729	EFR7303
KNORR	K062723K50	2920200604	KNORR	K066608K50	2925705390
KNORR	K062723K50	2927804	KNORR	K066608K50	2926900604
KNORR	K064513AT	EFR7314	KNORR	K066608K50	2926901
KNORR	K064514AT	EFR7315	KNORR	K066608K50	FCV4461PTS
KNORR	K064525	EFR7340	KNORR	K066608K64	2926900604
KNORR	K064525AT	EFR7340	KNORR	K066608K64	2926901
KNORR	K064526	EFR7341	KNORR	K066608K69	2926900604
KNORR	K064526AT	EFR7341	KNORR	K066608K69	2926901
KNORR	K064527	EFR7310	KNORR	K066610	EFR7342
KNORR	K064528	EFR7311	KNORR	K066611	EFR7343
KNORR	K064529	EFR7310	KNORR	K067417K50	CAC024
KNORR	K064529AT	EFR7310	KNORR	K067417K50	CAC042
KNORR	K064530	EFR7311	KNORR	K068872	EFR7314
KNORR	K064530AT	EFR7311	KNORR	K068873	EFR7315
KNORR	K064531	EFR7302	KNORR	K069333	09.9467.10
KNORR	K064532	EFR7303	KNORR	K069333	93087000
KNORR	K064533	EFR7302	KNORR	K069333	DF70002
KNORR	K064533AT	EFR7302	KNORR	K069333	FCR215A
KNORR	K064534	EFR7303	KNORR	K069393	EFR7354
KNORR	K064534AT	EFR7303	KNORR	K069394	EFR7355
KNORR	K064539	EFR7304	KNORR	K069395	EFR7354
KNORR	K064540	EFR7305	KNORR	K069396	EFR7355
KNORR	K064541	EFR7304	KNORR	K069434	EFR7300
KNORR	K064541AT	EFR7304	KNORR	K069434K53	EFR7300
KNORR	K064542	EFR7305	KNORR	K069435	EFR7301
KNORR	K064542AT	EFR7305	KNORR	K069435K53	EFR7301
KNORR	K064543	EFR7300	KNORR	K069436	EFR7333
KNORR	K064543AT	EFR7300	KNORR	K069436K53	EFR7333
KNORR	K064544	EFR7301	KNORR	K069437	EFR7332
KNORR	K064544AT	EFR7301	KNORR	K069437K53	EFR7332

Les correspondances de références ont pour seul objectif d'aider la recherche de référence

Cross references are there for the sole purpose of helping the reference search

CORRESPONDANCES DES REFERENCES CROSS REFERENCE LIST

MARQUE/MAKER	REF/PN OES	REF/PN	MARQUE/MAKER	REF/PN OES	REF/PN
KNORR	K069793	09.9983.60	KNORR	K071393K52	EFR7329
KNORR	K069793	93253000	KNORR	K071394	EFR7308
KNORR	K069793	DF70007	KNORR	K071394K52	EFR7308
KNORR	K069793	FCR318A	KNORR	K071395	EFR7309
KNORR	K069794	09.A562.10	KNORR	K071395K52	EFR7309
KNORR	K069794	93175200	KNORR	K071791	EFR7306
KNORR	K069794	FCR319A	KNORR	K071792	EFR7307
KNORR	K069795	09.A563.30	KNORR	K072207	EFR7314
KNORR	K069795	93127600	KNORR	K072208	EFR7315
KNORR	K069795	FCR239A	KNORR	K072209	EFR7315
KNORR	K069796	09.A563.40	KNORR	K072209AT	EFR7314
KNORR	K069796	93127500	KNORR	K072210	EFR7314
KNORR	K069796	FCR238A	KNORR	K072210AT	EFR7315
KNORR	K069797	09.A563.80	KNORR	K072296	EFR7310
KNORR	K069797	93309200	KNORR	K072297	EFR7311
KNORR	K069797	FCR308A	KNORR	K072298	EFR7304
KNORR	K069798	09.7929.90	KNORR	K072299	EFR7305
KNORR	K069798	93188600	KNORR	K072300	EFR7310
KNORR	K069798	FCR307A	KNORR	K072301	EFR7311
KNORR	K069799	09.9435.10	KNORR	K072502	EFR6306
KNORR	K069799	93087200	KNORR	K072503	EFR6307
KNORR	K069799	DF70001	KNORR	K072616	09.9900.10
KNORR	K069799	FCR214A	KNORR	K072616	92116500
KNORR	K069801	09.9181.10	KNORR	K072616	FCR210A
KNORR	K069801	93102300	KNORR	K075748	09.7870.10
KNORR	K069801	FCR187A	KNORR	K075748	93086100
KNORR	K069804	09.8367.10	KNORR	K075748	FCR134A
KNORR	K069804	93101700	KNORR	K075877	EFR7302
KNORR	K069804	FCR202A	KNORR	K075878	EFR7303
KNORR	K069805	09.8368.10	KNORR	K077253	EFR6306
KNORR	K069805	93101900	KNORR	K077253AT	EFR6306
KNORR	K069805	FCR203A	KNORR	K077254	EFR6307
KNORR	K069806	09.8543.10	KNORR	K077254AT	EFR6307
KNORR	K069806	93193600	KNORR	K078206K50	2932003
KNORR	K069806	FCR200A	KNORR	K078206K50	2932004
KNORR	K070049	EFR7302	KNORR	K078206K50	CVP036K
KNORR	K070049K52	EFR7302	KNORR	K080914	EFR7342
KNORR	K070050	EFR7303	KNORR	K080915	EFR7343
KNORR	K070050K52	EFR7303	KNORR	K081877	EFR7310
KNORR	K070895	EFR7321	KNORR	K081878	EFR7311
KNORR	K070895K55	EFR7321	KNORR	K081879	EFR7310
KNORR	K070896	EFR7320	KNORR	K081880	EFR7311
KNORR	K070896K55	EFR7320	KNORR	K081889	EFR7326
KNORR	K071018K50	2933100604	KNORR	K081890	EFR7327
KNORR	K071018K50	2933101	KNORR	K081891	EFR7326
KNORR	K071392	EFR7328	KNORR	K081892	EFR7327
KNORR	K071392K52	EFR7328	KNORR	K082433	EFR7353
KNORR	K071393	EFR7329	KNORR	K082434	EFR7352

Les correspondances de références ont pour seul objectif d'aider la recherche de référence

Cross references are there for the sole purpose of helping the reference search

CORRESPONDANCES DES REFERENCES CROSS REFERENCE LIST

MARQUE/MAKER	REF/PN OES	REF/PN	MARQUE/MAKER	REF/PN OES	REF/PN
KNORR	K082447	EFR7348	KNORR	K092092	EFR7317
KNORR	K082448	EFR7349	KNORR	K093081K51	EFR7304
KNORR	K082455	EFR7348	KNORR	K093082K51	EFR7305
KNORR	K082456	EFR7349	KNORR	K093103K51	EFR7304
KNORR	K082461	EFR7346	KNORR	K093104K51	EFR7305
KNORR	K082462	EFR7347	KNORR	K093105	EFR7342
KNORR	K082463	EFR7350	KNORR	K093105K51	EFR7343
KNORR	K082464	EFR7351	KNORR	K093106	EFR7343
KNORR	K082473	EFR7304	KNORR	K093106K51	EFR7342
KNORR	K082474	EFR7305	KNORR	K093606	EFR5303
KNORR	K082477	EFR7304	KNORR	K093607	EFR5302
KNORR	K082478	EFR7305	KNORR	K094058K51	EFR5300
KNORR	K082481	EFR7304	KNORR	K094059K51	EFR5301
KNORR	K082482	EFR7305	KNORR	K094177K51	EFR7304
KNORR	K082485	EFR7304	KNORR	K094178K51	EFR7305
KNORR	K082486	EFR7305	KNORR	K094192K51	EFR7300
KNORR	K082551	EFR5303	KNORR	K094193K51	EFR7301
KNORR	K082552	EFR5302	KNORR	K094233K51	EFR7305
KNORR	K087279K62	CAC024	KNORR	K094234K51	EFR7305
KNORR	K088633	EFR6304	KNORR	K094436K50	2920200604
KNORR	K088634	EFR6305	KNORR	K094436K50	2927802
KNORR	K088635	EFR6304	KNORR	K094436K50	2927804
KNORR	K088636	EFR6305	KNORR	K094643	EFR6306
KNORR	K088637	EFR6307	KNORR	K094644	EFR6307
KNORR	K088638	EFR6306	KNORR	K095048	EFR7302
KNORR	K088639	EFR6307	KNORR	K095049	EFR7303
KNORR	K088640	EFR6306	KNORR	K095050	EFR7310
KNORR	K090740	EFR7310	KNORR	K095051	EFR7311
KNORR	K090741	EFR7311	KNORR	K095052	EFR7302
KNORR	K090742	EFR7316	KNORR	K095053	EFR7303
KNORR	K090743	EFR7317	KNORR	K095533K51	EFR5302
KNORR	K090766	EFR7354	KNORR	K095534K51	EFR5303
KNORR	K090766N64	EFR7354	KNORR	K095726K55	EFR7335
KNORR	K090767	EFR7355	KNORR	K095727K55	EFR7334
KNORR	K090767N64	EFR7355	KNORR	K096186	EFR7343
KNORR	K090949K52	EFR7306	KNORR	K096187	EFR7342
KNORR	K090950K52	EFR7307	KNORR	K097440K51	EFR7300
KNORR	K091699	EFR7302	KNORR	K097441K51	EFR7301
KNORR	K091700	EFR7303	KNORR	K097530K50	EFR7354
KNORR	K092018	EFR5302	KNORR	K097530K64	EFR7354
KNORR	K092019	EFR5303	KNORR	K097531K50	EFR7355
KNORR	K092020	EFR5300	KNORR	K097531K64	EFR7355
KNORR	K092021	EFR5301	KNORR	K097533K50	2932801
KNORR	K092022	EFR5300	KNORR	K097533K50	FCV4736PTS
KNORR	K092023	EFR5301	KNORR	K097533K64	2932801
KNORR	K092024	EFR5302	KNORR	K097533K64	FCV4736PTS
KNORR	K092025	EFR5303	KNORR	K098864	EFR6300
KNORR	K092091	EFR7316	KNORR	K099579	EFR5302

Les correspondances de références ont pour seul objectif d'aider la recherche de référence

Cross references are there for the sole purpose of helping the reference search

CORRESPONDANCES DES REFERENCES CROSS REFERENCE LIST

MARQUE/MAKER	REF/PN OES	REF/PN	MARQUE/MAKER	REF/PN OES	REF/PN
KNORR	K099580	EFR5303	KNORR	K110087	EFR7317
KNORR	K100093	EFR7310	KNORR	K110103	EFR7314
KNORR	K100094	EFR7311	KNORR	K110104	EFR7315
KNORR	K100095	EFR7310	KNORR	K110105	EFR7302
KNORR	K100096	EFR7311	KNORR	K110106	EFR7303
KNORR	K101895	EFR7310	KNORR	K110127	EFR7302
KNORR	K101895N54	EFR7310	KNORR	K110128	EFR7303
KNORR	K101896	EFR7311	KNORR	K110129	EFR7300
KNORR	K101896N54	EFR7311	KNORR	K110130	EFR7301
KNORR	K105383	EFR7336	KNORR	K110131	EFR7302
KNORR	K105384	EFR7337	KNORR	K110132	EFR7303
KNORR	K107189	EFR7302	KNORR	K110133	EFR7310
KNORR	K107190	EFR7303	KNORR	K110134	EFR7311
KNORR	K107191	EFR7310	KNORR	K110135	EFR7310
KNORR	K107192	EFR7311	KNORR	K110136	EFR7311
KNORR	K107195	EFR7311	KNORR	K110166	EFR7300
KNORR	K107196	EFR7310	KNORR	K110167	EFR7301
KNORR	K107949K50	2920200604	KNORR	K110168	EFR7302
KNORR	K107949K50	2927802	KNORR	K110169	EFR7303
KNORR	K107949K50	2927804	KNORR	K110226	EFR6308
KNORR	K108020K50	2931801	KNORR	K110227	EFR6309
KNORR	K108020K50	FCV4725PTS	KNORR	K110228	EFR6308
KNORR	K108020K62	2931801	KNORR	K110229	EFR6309
KNORR	K108020K62	FCV4725PTS	KNORR	K110230	EFR6300
KNORR	K108461K50	2933100604	KNORR	K110231	EFR6301
KNORR	K108461K50	2933102	KNORR	K110232	EFR6300
KNORR	K109922	EFR6301	KNORR	K110233	EFR6301
KNORR	K109923	EFR6301	KNORR	K110259	EFR7302
KNORR	K109924	EFR6300	KNORR	K110260	EFR7303
KNORR	K109925	EFR7316	KNORR	K110265	EFR7302
KNORR	K109926	EFR7317	KNORR	K110266	EFR7303
KNORR	K109931	EFR6300	KNORR	K110267	EFR7310
KNORR	K109932	EFR6301	KNORR	K110268	EFR7311
KNORR	K109933	EFR6314	KNORR	K110269	EFR7302
KNORR	K109934	EFR6315	KNORR	K110270	EFR7303
KNORR	K109935	EFR6314	KNORR	K110271	EFR7302
KNORR	K109936	EFR6315	KNORR	K110272	EFR7303
KNORR	K109937	EFR6314	KNORR	K110273	EFR7304
KNORR	K109938	EFR6315	KNORR	K110274	EFR7305
KNORR	K109939	EFR6314	KNORR	K110275	EFR7300
KNORR	K109940	EFR6315	KNORR	K110276	EFR7301
KNORR	K109941	EFR6314	KNORR	K110277	EFR7300
KNORR	K109942	EFR6315	KNORR	K110278	EFR7301
KNORR	K109996	EFR7323	KNORR	K110279	EFR7300
KNORR	K109997	EFR7322	KNORR	K110280	EFR7301
KNORR	K110081	EFR7300	KNORR	K110281	EFR7308
KNORR	K110082	EFR7301	KNORR	K110282	EFR7309
KNORR	K110086	EFR7316	KNORR	K110283	EFR7308

Les correspondances de références ont pour seul objectif d'aider la recherche de référence

Cross references are there for the sole purpose of helping the reference search

CORRESPONDANCES DES REFERENCES CROSS REFERENCE LIST

MARQUE/MAKER	REF/PN OES	REF/PN	MARQUE/MAKER	REF/PN OES	REF/PN
KNORR	K110284	EFR7309	KNORR	K110462	EFR6301
KNORR	K110287	EFR7300	KNORR	K111102K53	EFR6313
KNORR	K110288	EFR7301	KNORR	K111103K53	EFR6312
KNORR	K110289	EFR7300	KNORR	K112661	EFR6300
KNORR	K110290	EFR7301	KNORR	K112661AT	EFR6300
KNORR	K110291	EFR7336	KNORR	K112662	EFR6301
KNORR	K110292	EFR7337	KNORR	K112662AT	EFR6301
KNORR	K110293	EFR7300	KNORR	K112663	EFR6306
KNORR	K110294	EFR7301	KNORR	K112663AT	EFR6306
KNORR	K110295	EFR7336	KNORR	K112664	EFR6307
KNORR	K110296	EFR7337	KNORR	K112664AT	EFR6307
KNORR	K110302	EFR7314	KNORR	K112747	EFR7300
KNORR	K110303	EFR7315	KNORR	K112748	EFR7301
KNORR	K110304	EFR7316	KNORR	K112749	EFR7300
KNORR	K110305	EFR7317	KNORR	K112750	EFR7301
KNORR	K110306	EFR6308	KNORR	K112946	EFR6300
KNORR	K110307	EFR6309	KNORR	K112947	EFR6301
KNORR	K110312	EFR6300	KNORR	K11305	EFR7317
KNORR	K110313	EFR6301	KNORR	K113467	EFR6306
KNORR	K110314	EFR6300	KNORR	K113468	EFR6307
KNORR	K110315	EFR6301	KNORR	K113518	EFR6308
KNORR	K110316	EFR6300	KNORR	K113519	EFR6309
KNORR	K110317	EFR6301	KNORR	K113718	EFR6300
KNORR	K110318	EFR6300	KNORR	K113719	EFR6301
KNORR	K110319	EFR6301	KNORR	K113720	EFR7300
KNORR	K110322	EFR6300	KNORR	K113721	EFR7301
KNORR	K110323	EFR6301	KNORR	K113722	EFR7300
KNORR	K110324	EFR6306	KNORR	K113723	EFR7301
KNORR	K110325	EFR6307	KNORR	K113724	EFR7300
KNORR	K110328	EFR6306	KNORR	K113725	EFR7301
KNORR	K110329	EFR6307	KNORR	K113726	EFR7300
KNORR	K110336	EFR5300	KNORR	K113727	EFR7301
KNORR	K110337	EFR5301	KNORR	K113728	EFR6308
KNORR	K110417	EFR6300	KNORR	K113729	EFR6309
KNORR	K110418	EFR6301	KNORR	K113730	EFR6308
KNORR	K110419	EFR6300	KNORR	K113731	EFR6309
KNORR	K110420	EFR6301	KNORR	K113732	EFR6308
KNORR	K110421	EFR6300	KNORR	K113733	EFR6309
KNORR	K110422	EFR6301	KNORR	K114142	EFR7302
KNORR	K110453	EFR6300	KNORR	K114143	EFR7303
KNORR	K110454	EFR6301	KNORR	K114823	EFR7304
KNORR	K110455	EFR6300	KNORR	K114824	EFR7305
KNORR	K110456	EFR6301	KNORR	K114977K55	EFR7323
KNORR	K110457	EFR6306	KNORR	K114978K55	EFR7322
KNORR	K110458	EFR6307	KNORR	K115441K50	2932003
KNORR	K110459	EFR6306	KNORR	K115441K50	2932004
KNORR	K110460	EFR6307	KNORR	K115613K51	EFR6308
KNORR	K110461	EFR6300	KNORR	K115614K51	EFR6309

Les correspondances de références ont pour seul objectif d'aider la recherche de référence

Cross references are there for the sole purpose of helping the reference search

CORRESPONDANCES DES REFERENCES CROSS REFERENCE LIST

MARQUE/MAKER	REF/PN OES	REF/PN	MARQUE/MAKER	REF/PN OES	REF/PN
KNORR	K115670	EFR6306	KNORR	K126631X50	EFR6308
KNORR	K115671	EFR6307	KNORR	K126632X50	EFR6309
KNORR	K115769	EFR7333	KNORR	K126860	EFR7300
KNORR	K115770	EFR7332	KNORR	K126861	EFR7301
KNORR	K115876	EFR7304	KNORR	K126862	EFR7300
KNORR	K115877	EFR7305	KNORR	K126863	EFR7301
KNORR	K116945K51	EFR6300	KNORR	K126864	EFR6300
KNORR	K116946K51	EFR6301	KNORR	K126865	EFR6301
KNORR	K117037K51	EFR7300	KNORR	K126866	EFR6308
KNORR	K117037K69	EFR7300	KNORR	K126867	EFR6309
KNORR	K117038K51	EFR7301	KNORR	K126868	EFR6300
KNORR	K117038K69	EFR7301	KNORR	K126869	EFR6301
KNORR	K118606K55	EFR7314	KNORR	K126870	EFR7300
KNORR	K118607K55	EFR7315	KNORR	K126871	EFR7301
KNORR	K119388K51	EFR6304	KNORR	K126872	EFR7300
KNORR	K119389K51	EFR6305	KNORR	K126873	EFR7301
KNORR	K119390K51	EFR6307	KNORR	K126874	EFR6308
KNORR	K119391K51	EFR6306	KNORR	K126875	EFR6309
KNORR	K119394K51	EFR6306	KNORR	K127593K53	EFR7304
KNORR	K119395K51	EFR6307	KNORR	K127594K53	EFR7305
KNORR	K119663K51	EFR7312	KNORR	K127595K53	EFR7300
KNORR	K119664K51	EFR7313	KNORR	K127596K53	EFR7301
KNORR	K119735	09.B325.30	KNORR	K127886K53	EFR6311
KNORR	K119735	93087900	KNORR	K127887K53	EFR6310
KNORR	K119735	DF70000	KNORR	K129843	EFR7310
KNORR	K119735	FCR145A	KNORR	K129844	EFR7311
KNORR	K119841	09.A741.10	KNORR	K130181	EFR7310
KNORR	K119841	93186700	KNORR	K130182	EFR7311
KNORR	K119841	DF70008	KNORR	K131120K50	2924401
KNORR	K119841	FCR323A	KNORR	K131120K50	FCV4418PTS
KNORR	K119842	09.C311.10	KNORR	K132084	EFR6306
KNORR	K119842	93291200	KNORR	K132085	EFR6307
KNORR	K119842	FCR372A	KNORR	K132662X50	EFR6308
KNORR	K120338K50	2918302	KNORR	K132663X50	EFR6309
KNORR	K124197	EFR7336	KNORR	K132664X50	EFR6301
KNORR	K124198	EFR7337	KNORR	K132665X50	EFR6300
KNORR	K124199	EFR7326	KNORR	K132685	EFR7354
KNORR	K124200	EFR7327	KNORR	K132686	EFR7355
KNORR	K124201	EFR7310	KNORR	K132858	EFR7354
KNORR	K124202	EFR7311	KNORR	K132859	EFR7355
KNORR	K124203	EFR7311	KNORR	K133485	EFR6306
KNORR	K124204	EFR7310	KNORR	K133486	EFR6307
KNORR	K124205	EFR7302	KNORR	K136360X50	EFR7310
KNORR	K124206	EFR7303	KNORR	K136361X50	EFR7311
KNORR	K124524	EFR7302	KNORR	K136362X50	EFR7304
KNORR	K124525	EFR7303	KNORR	K136363X50	EFR7305
KNORR	K124537	EFR7310	KNORR	K136386X50	EFR7302
KNORR	K124538	EFR7311	KNORR	K136387X50	EFR7303

Les correspondances de références ont pour seul objectif d'aider la recherche de référence

Cross references are there for the sole purpose of helping the reference search

CORRESPONDANCES DES REFERENCES CROSS REFERENCE LIST

MARQUE/MAKER	REF/PN OES	REF/PN	MARQUE/MAKER	REF/PN OES	REF/PN
KNORR	K136388X50	EFR7300	KNORR	SB6403RC	EFR6301
KNORR	K136389X50	EFR7301	KNORR	SB6404RC	EFR6301
KNORR	K138320	EFR7302	KNORR	SB6408	EFR6311
KNORR	K138321	EFR7303	KNORR	SB6408RC	EFR6311
KNORR	K139910K62	CAC007	KNORR	SB6410	EFR6300
KNORR	K139911K62	CAC024	KNORR	SB6410RC	EFR6300
KNORR	K140003	EFR6307	KNORR	SB6411	EFR6303
KNORR	K140004	EFR6306	KNORR	SB6411RC	EFR6303
KNORR	K140242X50	EFR7320	KNORR	SB6413	EFR6300
KNORR	K140243X50	EFR7321	KNORR	SB6413RC	EFR6300
KNORR	K140244X50	EFR7326	KNORR	SB6414RC	EFR6300
KNORR	K140245X50	EFR7327	KNORR	SB6418	EFR6310
KNORR	K140738X50	EFR7328	KNORR	SB6418RC	EFR6310
KNORR	K140739X50	EFR7329	KNORR	SB6500	EFR6300
KNORR	K140740X50	EFR7302	KNORR	SB6501	EFR6300
KNORR	K140741X50	EFR7303	KNORR	SB6502	EFR6300
KNORR	K140754X50	EFR6304	KNORR	SB6503	EFR6300
KNORR	K140755X50	EFR6305	KNORR	SB6504	EFR6300
KNORR	K140756X50	EFR6307	KNORR	SB6505	EFR6300
KNORR	K140757X50	EFR6306	KNORR	SB6506	EFR6307
KNORR	K140826K50	2932003	KNORR	SB6507	EFR6304
KNORR	K140826K50	2932004	KNORR	SB6508	EFR6300
KNORR	K149856X50	EFR7310	KNORR	SB6509	EFR6300
KNORR	K149857X50	EFR7311	KNORR	SB6510	EFR6301
KNORR	K149860X50	EFR7300	KNORR	SB6511	EFR6301
KNORR	K149861X50	EFR7301	KNORR	SB6512	EFR6301
KNORR	K155988K50	2932002	KNORR	SB6513	EFR6301
KNORR	K159176K50	2920200604	KNORR	SB6514	EFR6301
KNORR	K159176K50	2927804	KNORR	SB6515	EFR6301
KNORR	K180792K51	2924401	KNORR	SB6516	EFR6306
KNORR	K180792K51	FCV4418PTS	KNORR	SB6517	EFR6305
KNORR	K180908K50	2931801	KNORR	SB6518	EFR6301
KNORR	K180908K50	FCV4725PTS	KNORR	SB6519	EFR6301
KNORR	K212409	EFR7354	KNORR	SB6520	EFR6300
KNORR	K212410	EFR7355	KNORR	SB6521	EFR6300
KNORR	K222490	EFR7354	KNORR	SB6525	EFR6304
KNORR	K222491	EFR7355	KNORR	SB6526	EFR6304
KNORR	SB5002	EFR5301	KNORR	SB6527	EFR6300
KNORR	SB5003	EFR5303	KNORR	SB6528	EFR6302
KNORR	SB5006	EFR5303	KNORR	SB6529	EFR6300
KNORR	SB5012	EFR5300	KNORR	SB6530	EFR6301
KNORR	SB5013	EFR5302	KNORR	SB6531	EFR6301
KNORR	SB5016	EFR5302	KNORR	SB6535	EFR6305
KNORR	SB6400	EFR6301	KNORR	SB6536	EFR6305
KNORR	SB6400RC	EFR6301	KNORR	SB6537	EFR6301
KNORR	SB6401	EFR6302	KNORR	SB6538	EFR6303
KNORR	SB6401RC	EFR6302	KNORR	SB6539	EFR6301
KNORR	SB6403	EFR6301	KNORR	SB6540	EFR6300

Les correspondances de références ont pour seul objectif d'aider la recherche de référence

Cross references are there for the sole purpose of helping the reference search

CORRESPONDANCES DES REFERENCES CROSS REFERENCE LIST

MARQUE/MAKER	REF/PN OES	REF/PN	MARQUE/MAKER	REF/PN OES	REF/PN
KNORR	SB6540AT	EFR6300	KNORR	SB7103	EFR7306
KNORR	SB6541	EFR6310	KNORR	SB7103M1	EFR7306
KNORR	SB6542	EFR6300	KNORR	SB7104	EFR7306
KNORR	SB6543	EFR6307	KNORR	SB7105	EFR7314
KNORR	SB6545	EFR6300	KNORR	SB7108	EFR7316
KNORR	SB6546	EFR6300	KNORR	SB7109	EFR7314
KNORR	SB6547	EFR6311	KNORR	SB7112	EFR7325
KNORR	SB6547AT	EFR6311	KNORR	SB7113	EFR7307
KNORR	SB6548	EFR6300	KNORR	SB7113M1	EFR7307
KNORR	SB6549	EFR6304	KNORR	SB7114	EFR7307
KNORR	SB6550	EFR6301	KNORR	SB7115	EFR7315
KNORR	SB6550AT	EFR6301	KNORR	SB7118	EFR7317
KNORR	SB6551	EFR6311	KNORR	SB7119	EFR7315
KNORR	SB6552	EFR6301	KNORR	SB7120	EFR7324
KNORR	SB6553	EFR6306	KNORR	SB7122	EFR7324
KNORR	SB6555	EFR6301	KNORR	SB7123	EFR7314
KNORR	SB6556	EFR6301	KNORR	SB7124	EFR7316
KNORR	SB6557	EFR6310	KNORR	SB7125	EFR7314
KNORR	SB6557AT	EFR6310	KNORR	SB7126	EFR7324
KNORR	SB6558	EFR6301	KNORR	SB7127	EFR7306
KNORR	SB6559	EFR6305	KNORR	SB7128	EFR7324
KNORR	SB6561	EFR6300	KNORR	SB7129	EFR7306
KNORR	SB6563	EFR6300	KNORR	SB7130	EFR7325
KNORR	SB6566	EFR6300	KNORR	SB7132	EFR7325
KNORR	SB6567	EFR6300	KNORR	SB7133	EFR7315
KNORR	SB6571	EFR6301	KNORR	SB7134	EFR7317
KNORR	SB6573	EFR6301	KNORR	SB7135	EFR7315
KNORR	SB6576	EFR6301	KNORR	SB7136	EFR7325
KNORR	SB6577	EFR6301	KNORR	SB7137	EFR7307
KNORR	SB6582	EFR6302	KNORR	SB7138	EFR7325
KNORR	SB6584	EFR6300	KNORR	SB7139	EFR7307
KNORR	SB6585	EFR6300	KNORR	SB7140	EFR7314
KNORR	SB6586	EFR6300	KNORR	SB7144	EFR7314
KNORR	SB6592	EFR6303	KNORR	SB7145	EFR7306
KNORR	SB6594	EFR6301	KNORR	SB7146	EFR7316
KNORR	SB6595	EFR6301	KNORR	SB7147	EFR7314
KNORR	SB6596	EFR6301	KNORR	SB7148	EFR7314
KNORR	SB7005	EFR7302	KNORR	SB7149	EFR7314
KNORR	SB7015	EFR7303	KNORR	SB7150	EFR7315
KNORR	SB7021	EFR7302	KNORR	SB7154	EFR7315
KNORR	SB7022	EFR7302	KNORR	SB7155	EFR7307
KNORR	SB7031	EFR7303	KNORR	SB7156	EFR7317
KNORR	SB7032	EFR7303	KNORR	SB7157	EFR7315
KNORR	SB7040	EFR7302	KNORR	SB7158	EFR7315
KNORR	SB7041	EFR7302	KNORR	SB7159	EFR7315
KNORR	SB7050	EFR7303	KNORR	SB7167	EFR7306
KNORR	SB7051	EFR7303	KNORR	SB7168	EFR7314
KNORR	SB7102	EFR7324	KNORR	SB7168AT	EFR7314

Les correspondances de références ont pour seul objectif d'aider la recherche de référence

Cross references are there for the sole purpose of helping the reference search

CORRESPONDANCES DES REFERENCES CROSS REFERENCE LIST

MARQUE/MAKER	REF/PN OES	REF/PN	MARQUE/MAKER	REF/PN OES	REF/PN
KNORR	SB7169	EFR7316	KNORR	SB7212AT	EFR7334
KNORR	SB7169AT	EFR7316	KNORR	SB7212RC	EFR7334
KNORR	SB7177	EFR7307	KNORR	SB7213	EFR7307
KNORR	SB7178	EFR7315	KNORR	SB7215	EFR7315
KNORR	SB7178AT	EFR7315	KNORR	SB7216	EFR7315
KNORR	SB7179	EFR7317	KNORR	SB7217	EFR7307
KNORR	SB7179AT	EFR7317	KNORR	SB7218	EFR7314
KNORR	SB7180	EFR7316	KNORR	SB7218AT	EFR7315
KNORR	SB7180AT	EFR7316	KNORR	SB7219	EFR7317
KNORR	SB7181	EFR7314	KNORR	SB7220	EFR7323
KNORR	SB7182	EFR7306	KNORR	SB7220AT	EFR7323
KNORR	SB7182AT	EFR7306	KNORR	SB7220RC	EFR7323
KNORR	SB7184	EFR7314	KNORR	SB7221	EFR7306
KNORR	SB7185	EFR7314	KNORR	SB7222	EFR7314
KNORR	SB7185AT	EFR7314	KNORR	SB7222AT	EFR7314
KNORR	SB7186	EFR7314	KNORR	SB7225	EFR7314
KNORR	SB7187	EFR7316	KNORR	SB7226	EFR7314
KNORR	SB7187AT	EFR7316	KNORR	SB7227	EFR7314
KNORR	SB7188	EFR7314	KNORR	SB7228	EFR7340
KNORR	SB7189	EFR7306	KNORR	SB7229RC	EFR7341
KNORR	SB7190	EFR7317	KNORR	SB7230	EFR7322
KNORR	SB7190AT	EFR7317	KNORR	SB7230AT	EFR7322
KNORR	SB7191	EFR7315	KNORR	SB7230RC	EFR7322
KNORR	SB7192	EFR7307	KNORR	SB7231	EFR7307
KNORR	SB7192AT	EFR7307	KNORR	SB7232	EFR7315
KNORR	SB7194	EFR7315	KNORR	SB7232AT	EFR7315
KNORR	SB7195	EFR7315	KNORR	SB7235	EFR7315
KNORR	SB7195AT	EFR7315	KNORR	SB7236	EFR7315
KNORR	SB7196	EFR7315	KNORR	SB7237	EFR7315
KNORR	SB7197	EFR7317	KNORR	SB7238	EFR7341
KNORR	SB7197AT	EFR7317	KNORR	SB7239RC	EFR7340
KNORR	SB7198	EFR7315	KNORR	SB7243	EFR7314
KNORR	SB7199	EFR7307	KNORR	SB7244	EFR7306
KNORR	SB7200	EFR7324	KNORR	SB7244AT	EFR7306
KNORR	SB7201	EFR7314	KNORR	SB7246	EFR7316
KNORR	SB7202	EFR7335	KNORR	SB7247	EFR7316
KNORR	SB7202AT	EFR7335	KNORR	SB7253	EFR7315
KNORR	SB7202RC	EFR7335	KNORR	SB7254	EFR7307
KNORR	SB7203	EFR7306	KNORR	SB7254AT	EFR7307
KNORR	SB7205	EFR7314	KNORR	SB7256	EFR7317
KNORR	SB7206	EFR7314	KNORR	SB7257	EFR7317
KNORR	SB7207	EFR7306	KNORR	SB7401	EFR7301
KNORR	SB7208	EFR7314	KNORR	SB7401RC	EFR7301
KNORR	SB7208AT	EFR7314	KNORR	SB7403	EFR7304
KNORR	SB7209	EFR7316	KNORR	SB7403RC	EFR7304
KNORR	SB7210	EFR7325	KNORR	SB7405RC	EFR7311
KNORR	SB7211	EFR7315	KNORR	SB7409	EFR7303
KNORR	SB7212	EFR7334	KNORR	SB7409RC	EFR7303

Les correspondances de références ont pour seul objectif d'aider la recherche de référence

Cross references are there for the sole purpose of helping the reference search

CORRESPONDANCES DES REFERENCES CROSS REFERENCE LIST

MARQUE/MAKER	REF/PN OES	REF/PN	MARQUE/MAKER	REF/PN OES	REF/PN
KNORR	SB7411	EFR7300	KNORR	SB7466RC	EFR7314
KNORR	SB7411RC	EFR7300	KNORR	SB7500	EFR7310
KNORR	SB7413	EFR7305	KNORR	SB7501	EFR7302
KNORR	SB7413RC	EFR7305	KNORR	SB7505	EFR7302
KNORR	SB7415RC	EFR7310	KNORR	SB7508	EFR7302
KNORR	SB7419	EFR7302	KNORR	SB7508AT	EFR7302
KNORR	SB7419RC	EFR7302	KNORR	SB7509	EFR7316
KNORR	SB7420	EFR7301	KNORR	SB7510	EFR7311
KNORR	SB7420RC	EFR7301	KNORR	SB7511	EFR7303
KNORR	SB7422	EFR7313	KNORR	SB7515	EFR7303
KNORR	SB7422RC	EFR7313	KNORR	SB7518	EFR7303
KNORR	SB7424	EFR7303	KNORR	SB7518AT	EFR7303
KNORR	SB7424RC	EFR7303	KNORR	SB7519	EFR7317
KNORR	SB7425RC	EFR7322	KNORR	SB7521	EFR7302
KNORR	SB7426	EFR7334	KNORR	SB7522	EFR7302
KNORR	SB7426RC	EFR7334	KNORR	SB7524	EFR7300
KNORR	SB7430	EFR7300	KNORR	SB7531	EFR7303
KNORR	SB7430RC	EFR7300	KNORR	SB7532	EFR7303
KNORR	SB7432	EFR7312	KNORR	SB7534	EFR7301
KNORR	SB7432RC	EFR7312	KNORR	SB7540	EFR7302
KNORR	SB7434	EFR7302	KNORR	SB7541	EFR7302
KNORR	SB7434RC	EFR7302	KNORR	SB7549	EFR7300
KNORR	SB7435RC	EFR7323	KNORR	SB7550	EFR7303
KNORR	SB7436	EFR7335	KNORR	SB7551	EFR7303
KNORR	SB7436RC	EFR7335	KNORR	SB7559	EFR7301
KNORR	SB7450	EFR7315	KNORR	SB7560	EFR7300
KNORR	SB7450RC	EFR7315	KNORR	SB7564	EFR7302
KNORR	SB7451	EFR7317	KNORR	SB7570	EFR7301
KNORR	SB7451RC	EFR7317	KNORR	SB7574	EFR7303
KNORR	SB7452	EFR7307	KNORR	SB7580	EFR7300
KNORR	SB7452RC	EFR7307	KNORR	SB7581	EFR7302
KNORR	SB7453	EFR7325	KNORR	SB7584	EFR7302
KNORR	SB7453RC	EFR7325	KNORR	SB7585	EFR7302
KNORR	SB7455	EFR7325	KNORR	SB7586	EFR7310
KNORR	SB7455RC	EFR7325	KNORR	SB7588	EFR7302
KNORR	SB7456	EFR7315	KNORR	SB7589	EFR7302
KNORR	SB7456RC	EFR7315	KNORR	SB7590	EFR7301
KNORR	SB7460	EFR7314	KNORR	SB7591	EFR7303
KNORR	SB7460RC	EFR7314	KNORR	SB7594	EFR7303
KNORR	SB7461	EFR7316	KNORR	SB7595	EFR7303
KNORR	SB7461RC	EFR7316	KNORR	SB7596	EFR7311
KNORR	SB7462	EFR7306	KNORR	SB7598	EFR7303
KNORR	SB7462RC	EFR7306	KNORR	SB7599	EFR7303
KNORR	SB7463	EFR7324	KNORR	SB7600	EFR7302
KNORR	SB7463RC	EFR7324	KNORR	SB7601	EFR7300
KNORR	SB7465	EFR7324	KNORR	SB7602	EFR7304
KNORR	SB7465RC	EFR7324	KNORR	SB7604	EFR7302
KNORR	SB7466	EFR7314	KNORR	SB7604AT	EFR7302

Les correspondances de références ont pour seul objectif d'aider la recherche de référence

Cross references are there for the sole purpose of helping the reference search

CORRESPONDANCES DES REFERENCES CROSS REFERENCE LIST

MARQUE/MAKER	REF/PN OES	REF/PN	MARQUE/MAKER	REF/PN OES	REF/PN
KNORR	SB7607	EFR7302	KNORR	SB7701AT	EFR7301
KNORR	SB7608	EFR7302	KNORR	SB7702	EFR7301
KNORR	SB7609	EFR7300	KNORR	SB7703	EFR7302
KNORR	SB7610	EFR7303	KNORR	SB7704	EFR7302
KNORR	SB7611	EFR7301	KNORR	SB7705	EFR7302
KNORR	SB7612	EFR7305	KNORR	SB7706	EFR7302
KNORR	SB7614	EFR7303	KNORR	SB7707	EFR7302
KNORR	SB7614AT	EFR7303	KNORR	SB7708	EFR7302
KNORR	SB7617	EFR7303	KNORR	SB7709	EFR7301
KNORR	SB7618	EFR7303	KNORR	SB7711	EFR7300
KNORR	SB7619	EFR7301	KNORR	SB7711AT	EFR7300
KNORR	SB7621	EFR7310	KNORR	SB7712	EFR7300
KNORR	SB7623	EFR7300	KNORR	SB7713	EFR7303
KNORR	SB7624	EFR7302	KNORR	SB7714	EFR7303
KNORR	SB7629	EFR7302	KNORR	SB7715	EFR7303
KNORR	SB7631	EFR7311	KNORR	SB7716	EFR7303
KNORR	SB7633	EFR7301	KNORR	SB7717	EFR7303
KNORR	SB7634	EFR7303	KNORR	SB7718	EFR7303
KNORR	SB7639	EFR7303	KNORR	SB7719	EFR7300
KNORR	SB7640	EFR7302	KNORR	SB7721	EFR7302
KNORR	SB7648	EFR7304	KNORR	SB7723	EFR7300
KNORR	SB7648AT	EFR7304	KNORR	SB7724	EFR7300
KNORR	SB7649	EFR7304	KNORR	SB7725	EFR7302
KNORR	SB7650	EFR7303	KNORR	SB7726	EFR7302
KNORR	SB7658	EFR7305	KNORR	SB7729	EFR7302
KNORR	SB7658AT	EFR7305	KNORR	SB7730	EFR7303
KNORR	SB7659	EFR7305	KNORR	SB7731	EFR7303
KNORR	SB7660	EFR7304	KNORR	SB7733	EFR7301
KNORR	SB7661	EFR7302	KNORR	SB7734	EFR7301
KNORR	SB7662	EFR7300	KNORR	SB7735	EFR7303
KNORR	SB7665	EFR7301	KNORR	SB7736	EFR7303
KNORR	SB7666	EFR7302	KNORR	SB7742	EFR7302
KNORR	SB7670	EFR7305	KNORR	SB7744	EFR7300
KNORR	SB7671	EFR7303	KNORR	SB7745	EFR7302
KNORR	SB7672	EFR7301	KNORR	SB7746	EFR7304
KNORR	SB7675	EFR7300	KNORR	SB7748	EFR7300
KNORR	SB7676	EFR7303	KNORR	SB7749	EFR7304
KNORR	SB7679	EFR7300	KNORR	SB7752	EFR7303
KNORR	SB7680	EFR7300	KNORR	SB7754	EFR7301
KNORR	SB7681	EFR7300	KNORR	SB7755	EFR7303
KNORR	SB7682	EFR7300	KNORR	SB7756	EFR7305
KNORR	SB7688	EFR7302	KNORR	SB7757	EFR7309
KNORR	SB7689	EFR7301	KNORR	SB7758	EFR7301
KNORR	SB7690	EFR7301	KNORR	SB7759	EFR7305
KNORR	SB7691	EFR7301	KNORR	SB7760	EFR7304
KNORR	SB7692	EFR7301	KNORR	SB7761	EFR7310
KNORR	SB7698	EFR7303	KNORR	SB7762	EFR7302
KNORR	SB7701	EFR7301	KNORR	SB7766	EFR7312

Les correspondances de références ont pour seul objectif d'aider la recherche de référence

Cross references are there for the sole purpose of helping the reference search

CORRESPONDANCES DES REFERENCES CROSS REFERENCE LIST

MARQUE/MAKER	REF/PN OES	REF/PN	MARQUE/MAKER	REF/PN OES	REF/PN
KNORR	SB7766AT	EFR7312	KNORR	SB7834	EFR7313
KNORR	SB7767	EFR7302	KNORR	SB7835	EFR7303
KNORR	SB7770	EFR7305	KNORR	SB7836	EFR7311
KNORR	SB7771	EFR7311	KNORR	SB7838	EFR7309
KNORR	SB7772	EFR7303	KNORR	SB7839	EFR7303
KNORR	SB7776	EFR7313	KNORR	SB7842	EFR7316
KNORR	SB7776AT	EFR7313	KNORR	SB7846	EFR7326
KNORR	SB7777	EFR7303	KNORR	SB7852	EFR7317
KNORR	SB7780	EFR7310	KNORR	SB7856	EFR7327
KNORR	SB7781	EFR7302	KNORR	SB7857	EFR7302
KNORR	SB7782	EFR7304	KNORR	SB7858	EFR7312
KNORR	SB7783	EFR7310	KNORR	SB7860	EFR7303
KNORR	SB7784	EFR7300	KNORR	SB7861	EFR7302
KNORR	SB7785	EFR7310	KNORR	SB7863	EFR7302
KNORR	SB7786	EFR7304	KNORR	SB7865	EFR7300
KNORR	SB7787	EFR7304	KNORR	SB7867	EFR7303
KNORR	SB7788	EFR7302	KNORR	SB7868	EFR7313
KNORR	SB7789	EFR7302	KNORR	SB7869	EFR7309
KNORR	SB7790	EFR7311	KNORR	SB7870	EFR7302
KNORR	SB7791	EFR7303	KNORR	SB7871	EFR7303
KNORR	SB7792	EFR7305	KNORR	SB7873	EFR7303
KNORR	SB7793	EFR7311	KNORR	SB7875	EFR7301
KNORR	SB7794	EFR7301	KNORR	SB7880	EFR7308
KNORR	SB7795	EFR7311	KNORR	SB7881	EFR7302
KNORR	SB7796	EFR7305	KNORR	SB7883	EFR7302
KNORR	SB7797	EFR7305	KNORR	SB7884	EFR7310
KNORR	SB7798	EFR7303	KNORR	SB7886	EFR7300
KNORR	SB7799	EFR7303	KNORR	SB7887	EFR7304
KNORR	SB7800	EFR7300	KNORR	SB7888	EFR7302
KNORR	SB7801	EFR7300	KNORR	SB7889	EFR7310
KNORR	SB7803	EFR7300	KNORR	SB7890	EFR7309
KNORR	SB7806	EFR7300	KNORR	SB7891	EFR7303
KNORR	SB7807	EFR7310	KNORR	SB7893	EFR7303
KNORR	SB7810	EFR7301	KNORR	SB7894	EFR7311
KNORR	SB7811	EFR7301	KNORR	SB7896	EFR7301
KNORR	SB7813	EFR7301	KNORR	SB7897	EFR7305
KNORR	SB7816	EFR7301	KNORR	SB7898	EFR7303
KNORR	SB7817	EFR7311	KNORR	SB7899	EFR7311
KNORR	SB7818	EFR7301	KNORR	SB7900	EFR7302
KNORR	SB7820	EFR7308	KNORR	SB7901	EFR7300
KNORR	SB7822AT	EFR7314	KNORR	SB7902	EFR7304
KNORR	SB7824	EFR7312	KNORR	SB7902AT	EFR7304
KNORR	SB7825	EFR7302	KNORR	SB7903	EFR7300
KNORR	SB7826	EFR7310	KNORR	SB7904	EFR7302
KNORR	SB7828	EFR7308	KNORR	SB7905	EFR7302
KNORR	SB7829	EFR7302	KNORR	SB7906	EFR7300
KNORR	SB7830	EFR7309	KNORR	SB7906AT	EFR7300
KNORR	SB7832AT	EFR7315	KNORR	SB7907	EFR7300

Les correspondances de références ont pour seul objectif d'aider la recherche de référence

Cross references are there for the sole purpose of helping the reference search

CORRESPONDANCES DES REFERENCES CROSS REFERENCE LIST

MARQUE/MAKER	REF/PN OES	REF/PN	MARQUE/MAKER	REF/PN OES	REF/PN
KNORR	SB7908	EFR7308	KNORR	SB7xxx	EFR7302
KNORR	SB7909	EFR7302	KNORR	SB7xxx	EFR7303
KNORR	SB7910	EFR7303	KNORR	SK7001	EFR6308
KNORR	SB7911	EFR7301	KNORR	SK7002	EFR6308
KNORR	SB7912	EFR7305	KNORR	SK7003	EFR6308
KNORR	SB7912AT	EFR7305	KNORR	SK7004	EFR6308
KNORR	SB7913	EFR7301	KNORR	SK7006	EFR6308
KNORR	SB7914	EFR7303	KNORR	SK7007	EFR6308
KNORR	SB7915	EFR7303	KNORR	SK7007AT	EFR6308
KNORR	SB7916	EFR7301	KNORR	SK7008	EFR6308
KNORR	SB7916AT	EFR7301	KNORR	SK7009	EFR6308
KNORR	SB7917	EFR7301	KNORR	SK7011	EFR6309
KNORR	SB7918	EFR7309	KNORR	SK7012	EFR6309
KNORR	SB7919	EFR7303	KNORR	SK7013	EFR6309
KNORR	SB7922	EFR7308	KNORR	SK7014	EFR6309
KNORR	SB7929	EFR7300	KNORR	SK7016	EFR6309
KNORR	SB7932	EFR7309	KNORR	SK7017	EFR6309
KNORR	SB7939	EFR7301	KNORR	SK7017AT	EFR6309
KNORR	SB7940	EFR7302	KNORR	SK7018	EFR6309
KNORR	SB7942	EFR7316	KNORR	SK7019	EFR6309
KNORR	SB7946	EFR7304	KNORR	SK7025	EFR6308
KNORR	SB7947	EFR7304	KNORR	SK7026	EFR6308
KNORR	SB7948	EFR7304	KNORR	SK7028	EFR6308
KNORR	SB7950	EFR7303	KNORR	SK7029	EFR6308
KNORR	SB7952	EFR7317	KNORR	SK7035	EFR6309
KNORR	SB7953	EFR7309	KNORR	SK7036	EFR6309
KNORR	SB7955	EFR7309	KNORR	SK7038	EFR6309
KNORR	SB7956	EFR7305	KNORR	SK7039	EFR6309
KNORR	SB7957	EFR7305	KNORR	SK7041	EFR6308
KNORR	SB7958	EFR7305	KNORR	SK7042	EFR6308
KNORR	SB7960	EFR7302	KNORR	SK7042RC	EFR6308
KNORR	SB7962	EFR7302	KNORR	SK7051	EFR6309
KNORR	SB7963	EFR7314	KNORR	SK7052	EFR6309
KNORR	SB7964	EFR7302	KNORR	SK7052RC	EFR6309
KNORR	SB7965	EFR7300	KNORR	SL7504	EFR7346
KNORR	SB7966	EFR7314	KNORR	SL7504RC	EFR7346
KNORR	SB7967	EFR7340	KNORR	SL7505	EFR7350
KNORR	SB7967AT	EFR7340	KNORR	SL7505RC	EFR7350
KNORR	SB7970	EFR7303	KNORR	SL7514	EFR7347
KNORR	SB7972	EFR7303	KNORR	SL7514RC	EFR7347
KNORR	SB7973	EFR7315	KNORR	SL7515	EFR7351
KNORR	SB7974	EFR7303	KNORR	SL7515RC	EFR7351
KNORR	SB7975	EFR7301	KNORR	SM7003	EFR7348
KNORR	SB7976	EFR7315	KNORR	SM7003RC	EFR7348
KNORR	SB7977	EFR7341	KNORR	SM7007	EFR7348
KNORR	SB7977AT	EFR7341	KNORR	SM7013	EFR7349
KNORR	SB7989	EFR7302	KNORR	SM7013RC	EFR7349
KNORR	SB7999	EFR7303	KNORR	SM7017	EFR7349

Les correspondances de références ont pour seul objectif d'aider la recherche de référence

Cross references are there for the sole purpose of helping the reference search

CORRESPONDANCES DES REFERENCES CROSS REFERENCE LIST

MARQUE/MAKER	REF/PN OES	REF/PN	MARQUE/MAKER	REF/PN OES	REF/PN
KNORR	SM7500	EFR7353	KNORR	SN5031	EFR5301
KNORR	SM7500RC	EFR7353	KNORR	SN5033RC	EFR5305
KNORR	SM7510	EFR7352	KNORR	SN5034	EFR5301
KNORR	SM7510RC	EFR7352	KNORR	SN5037	EFR5300
KNORR	SN5001-K001942	EFR5304	KNORR	SN5038	EFR5302
KNORR	SN5001-K001944	EFR5304	KNORR	SN5039	EFR5303
KNORR	SN5001-K011178	EFR5304	KNORR	SN6500	EFR6314
KNORR	SN5001-K011180	EFR5304	KNORR	SN6504	EFR6304
KNORR	SN5001-K011237	EFR5304	KNORR	SN6504-K001763	EFR6307
KNORR	SN5001-K015972	EFR5304	KNORR	SN6504-K001765	EFR6307
KNORR	SN5001-K016618	EFR5304	KNORR	SN6504-K001767	EFR6304
KNORR	SN5001-K016621	EFR5304	KNORR	SN6504-K001769	EFR6304
KNORR	SN5001-K016626	EFR5304	KNORR	SN6504-K002063	EFR6304
KNORR	SN5002	EFR5301	KNORR	SN6504-K002065	EFR6304
KNORR	SN5002AT	EFR5301	KNORR	SN6504-K009912	EFR6304
KNORR	SN5003	EFR5303	KNORR	SN6504-K009914	EFR6304
KNORR	SN5003AT	EFR5303	KNORR	SN6504-K015806	EFR6304
KNORR	SN5005	EFR5301	KNORR	SN6504-K028457	EFR6307
KNORR	SN5005RC	EFR5301	KNORR	SN6507	EFR6300
KNORR	SN5006	EFR5303	KNORR	SN6508	EFR6301
KNORR	SN5006RC	EFR5303	KNORR	SN6509	EFR6314
KNORR	SN5007	EFR5302	KNORR	SN6510	EFR6315
KNORR	SN5011-K001943	EFR5305	KNORR	SN6514-K001764	EFR6306
KNORR	SN5011-K001945	EFR5305	KNORR	SN6514-K001766	EFR6306
KNORR	SN5011-K011179	EFR5305	KNORR	SN6514-K001768	EFR6305
KNORR	SN5011-K011181	EFR5305	KNORR	SN6514-K001770	EFR6305
KNORR	SN5011-K011238	EFR5305	KNORR	SN6514-K002064	EFR6305
KNORR	SN5011-K015973	EFR5305	KNORR	SN6514-K002066	EFR6305
KNORR	SN5011-K016619	EFR5305	KNORR	SN6514-K009913	EFR6305
KNORR	SN5011-K016620	EFR5305	KNORR	SN6514-K009915	EFR6305
KNORR	SN5011-K016627	EFR5305	KNORR	SN6514-K015807	EFR6305
KNORR	SN5011RC	EFR5300	KNORR	SN6514-K028458	EFR6306
KNORR	SN5012	EFR5300	KNORR	SN6517	EFR6301
KNORR	SN5012AT	EFR5300	KNORR	SN6518	EFR6300
KNORR	SN5013	EFR5302	KNORR	SN6519	EFR6315
KNORR	SN5013AT	EFR5302	KNORR	SN6523	EFR6313
KNORR	SN5015	EFR5300	KNORR	SN6527	EFR6300
KNORR	SN5015RC	EFR5300	KNORR	SN6527AT	EFR6300
KNORR	SN5016	EFR5302	KNORR	SN6528	EFR6300
KNORR	SN5016RC	EFR5302	KNORR	SN6529	EFR6300
KNORR	SN5017	EFR5303	KNORR	SN6533	EFR6312
KNORR	SN5021	EFR5300	KNORR	SN6537	EFR6301
KNORR	SN5021RC	EFR5301	KNORR	SN6537AT	EFR6301
KNORR	SN5023RC	EFR5304	KNORR	SN6538	EFR6301
KNORR	SN5024	EFR5300	KNORR	SN6539	EFR6301
KNORR	SN5027	EFR5301	KNORR	SN6541-K001175	EFR6306
KNORR	SN5028	EFR5303	KNORR	SN6541-K001177	EFR6305
KNORR	SN5029	EFR5302	KNORR	SN6541-K003715	EFR6306

Les correspondances de références ont pour seul objectif d'aider la recherche de référence

Cross references are there for the sole purpose of helping the reference search

CORRESPONDANCES DES REFERENCES CROSS REFERENCE LIST

MARQUE/MAKER	REF/PN OES	REF/PN	MARQUE/MAKER	REF/PN OES	REF/PN
KNORR	SN6541-K003717	EFR6305	KNORR	SN6560	EFR6306
KNORR	SN6541-K012731	EFR6306	KNORR	SN6561	EFR6312
KNORR	SN6541-K015899	EFR6305	KNORR	SN6561AT	EFR6312
KNORR	SN6541-K032578	EFR6306	KNORR	SN6562	EFR6301
KNORR	SN6541-K032585	EFR6306	KNORR	SN6563	EFR6300
KNORR	SN6542	EFR6300	KNORR	SN6563RC	EFR6300
KNORR	SN6543	EFR6300	KNORR	SN6564	EFR6312
KNORR	SN6545	EFR6300	KNORR	SN6564RC	EFR6312
KNORR	SN6546	EFR6300	KNORR	SN6565	EFR6300
KNORR	SN6547	EFR6300	KNORR	SN6565RC	EFR6300
KNORR	SN6549	EFR6300	KNORR	SN6566RC	EFR6314
KNORR	SN6550	EFR6307	KNORR	SN6567	EFR6304
KNORR	SN6551-K001176	EFR6307	KNORR	SN6567RC	EFR6304
KNORR	SN6551-K001178	EFR6304	KNORR	SN6568	EFR6307
KNORR	SN6551-K002107	EFR6313	KNORR	SN6568RC	EFR6307
KNORR	SN6551-K003716	EFR6307	KNORR	SN6569	EFR6317
KNORR	SN6551-K003718	EFR6304	KNORR	SN6570	EFR6301
KNORR	SN6551-K012732	EFR6307	KNORR	SN6570RC	EFR6301
KNORR	SN6551-K013818	EFR6313	KNORR	SN6571	EFR6300
KNORR	SN6551-K015900	EFR6304	KNORR	SN6571RC	EFR6300
KNORR	SN6551-K025626	EFR6313	KNORR	SN6572	EFR6300
KNORR	SN6551-K032579	EFR6307	KNORR	SN6572RC	EFR6300
KNORR	SN6551-K032586	EFR6307	KNORR	SN6573	EFR6301
KNORR	SN6552	EFR6301	KNORR	SN6573RC	EFR6301
KNORR	SN6552-K001339	EFR6301	KNORR	SN6574	EFR6301
KNORR	SN6552-K002515	EFR6300	KNORR	SN6575	EFR6300
KNORR	SN6552-K014941	EFR6300	KNORR	SN6576	EFR6300
KNORR	SN6553	EFR6301	KNORR	SN6576AT	EFR6300
KNORR	SN6554	EFR6313	KNORR	SN6577	EFR6306
KNORR	SN6554RC	EFR6313	KNORR	SN6578	EFR6300
KNORR	SN6555	EFR6301	KNORR	SN6579	EFR6316
KNORR	SN6555RC	EFR6301	KNORR	SN6580	EFR6300
KNORR	SN6556	EFR6301	KNORR	SN6580RC	EFR6300
KNORR	SN6556-K001443	EFR6301	KNORR	SN6581	EFR6301
KNORR	SN6556-K009161	EFR6315	KNORR	SN6581RC	EFR6301
KNORR	SN6556-K013870	EFR6301	KNORR	SN6582	EFR6301
KNORR	SN6556RC	EFR6315	KNORR	SN6582RC	EFR6301
KNORR	SN6557	EFR6305	KNORR	SN6584	EFR6301
KNORR	SN6557-K001445	EFR6301	KNORR	SN6585	EFR6301
KNORR	SN6557-K003791	EFR6305	KNORR	SN6586	EFR6301
KNORR	SN6557-K013175	EFR6305	KNORR	SN6586AT	EFR6301
KNORR	SN6557-K013872	EFR6301	KNORR	SN6587	EFR6307
KNORR	SN6557RC	EFR6305	KNORR	SN6588	EFR6301
KNORR	SN6557RC-K003791	EFR6305	KNORR	SN6589	EFR6305
KNORR	SN6557RC-K013175	EFR6305	KNORR	SN6590	EFR6300
KNORR	SN6558	EFR6306	KNORR	SN6591	EFR6300
KNORR	SN6558RC	EFR6306	KNORR	SN6592	EFR6300
KNORR	SN6559	EFR6301	KNORR	SN6594	EFR6300

Les correspondances de références ont pour seul objectif d'aider la recherche de référence

Cross references are there for the sole purpose of helping the reference search

CORRESPONDANCES DES REFERENCES CROSS REFERENCE LIST

MARQUE/MAKER	REF/PN OES	REF/PN	MARQUE/MAKER	REF/PN OES	REF/PN
KNORR	SN6595RC	EFR6316	KNORR	SN6680	EFR6301
KNORR	SN6596	EFR6300	KNORR	SN6681	EFR6301
KNORR	SN6597	EFR6300	KNORR	SN6683	EFR6307
KNORR	SN6599	EFR6304	KNORR	SN6684	EFR6307
KNORR	SN6600	EFR6301	KNORR	SN6685	EFR6307
KNORR	SN6601	EFR6301	KNORR	SN7020	EFR7304
KNORR	SN6602	EFR6301	KNORR	SN7020AT	EFR7304
KNORR	SN6604	EFR6301	KNORR	SN7020-II39515F	EFR7300
KNORR	SN6605RC	EFR6317	KNORR	SN7020-K000202	EFR7300
KNORR	SN6606	EFR6301	KNORR	SN7020-K000204	EFR7300
KNORR	SN6607	EFR6301	KNORR	SN7020-K000306	EFR7300
KNORR	SN6609	EFR6313	KNORR	SN7020-K002357	EFR7300
KNORR	SN6610RC	EFR6307	KNORR	SN7020-K002359	EFR7300
KNORR	SN6616	EFR6300	KNORR	SN7020-K002361	EFR7304
KNORR	SN6619	EFR6312	KNORR	SN7020-K002363	EFR7304
KNORR	SN6620RC	EFR6306	KNORR	SN7020-K007088	EFR7300
KNORR	SN6626	EFR6301	KNORR	SN7020-K007090	EFR7300
KNORR	SN6628	EFR6304	KNORR	SN7020-K007092	EFR7304
KNORR	SN6628AT	EFR6304	KNORR	SN7020-K007094	EFR7300
KNORR	SN6629	EFR6304	KNORR	SN7020-K007096	EFR7304
KNORR	SN6630	EFR6307	KNORR	SN7020-K007098	EFR7304
KNORR	SN6630AT	EFR6307	KNORR	SN7020-K082473	EFR7304
KNORR	SN6631	EFR6307	KNORR	SN7020-K082477	EFR7304
KNORR	SN6638	EFR6305	KNORR	SN7020-Z000723	EFR7304
KNORR	SN6638AT	EFR6305	KNORR	SN7020-Z000725	EFR7304
KNORR	SN6639	EFR6305	KNORR	SN7021	EFR7304
KNORR	SN6640	EFR6306	KNORR	SN7021-II39537F	EFR7300
KNORR	SN6640AT	EFR6306	KNORR	SN7021-K002349	EFR7304
KNORR	SN6641	EFR6306	KNORR	SN7021-K002351	EFR7304
KNORR	SN6653	EFR6300	KNORR	SN7021-K007187	EFR7304
KNORR	SN6654RC	EFR6300	KNORR	SN7021-K007189	EFR7304
KNORR	SN6655	EFR6306	KNORR	SN7021-K010147	EFR7304
KNORR	SN6655AT	EFR6306	KNORR	SN7021-K010897	EFR7300
KNORR	SN6656	EFR6306	KNORR	SN7021-K010899	EFR7300
KNORR	SN6663	EFR6301	KNORR	SN7021-K010901	EFR7300
KNORR	SN6664RC	EFR6301	KNORR	SN7021-Z0010001	EFR7304
KNORR	SN6665	EFR6307	KNORR	SN7021-Z0010003	EFR7304
KNORR	SN6665AT	EFR6307	KNORR	SN7022	EFR7304
KNORR	SN6666	EFR6307	KNORR	SN7022-II39539F	EFR7304
KNORR	SN6668	EFR6300	KNORR	SN7022-K000206	EFR7300
KNORR	SN6669	EFR6306	KNORR	SN7022-K000208	EFR7300
KNORR	SN6670	EFR6300	KNORR	SN7022-K002337	EFR7304
KNORR	SN6671	EFR6300	KNORR	SN7022-K002339	EFR7304
KNORR	SN6673	EFR6306	KNORR	SN7022-K002341	EFR7300
KNORR	SN6674	EFR6306	KNORR	SN7022-K002343	EFR7300
KNORR	SN6675	EFR6306	KNORR	SN7022-K004276	EFR7304
KNORR	SN6678	EFR6301	KNORR	SN7022-K004278	EFR7300
KNORR	SN6679	EFR6307	KNORR	SN7022-K007151	EFR7300

Les correspondances de références ont pour seul objectif d'aider la recherche de référence

Cross references are there for the sole purpose of helping the reference search

CORRESPONDANCES DES REFERENCES CROSS REFERENCE LIST

MARQUE/MAKER	REF/PN OES	REF/PN	MARQUE/MAKER	REF/PN OES	REF/PN
KNORR	SN7022-K007155	EFR7304	KNORR	SN7032-K002338	EFR7305
KNORR	SN7022-K007159	EFR7304	KNORR	SN7032-K002340	EFR7305
KNORR	SN7022-K010149	EFR7304	KNORR	SN7032-K002342	EFR7301
KNORR	SN7022-K010151	EFR7300	KNORR	SN7032-K002344	EFR7301
KNORR	SN7022-K082481	EFR7304	KNORR	SN7032-K004277	EFR7305
KNORR	SN7022-K082485	EFR7304	KNORR	SN7032-K004279	EFR7301
KNORR	SN7022-Z0010291	EFR7304	KNORR	SN7032-K007152	EFR7301
KNORR	SN7022-Z0010293	EFR7304	KNORR	SN7032-K007156	EFR7305
KNORR	SN7024	EFR7304	KNORR	SN7032-K007160	EFR7305
KNORR	SN7028	EFR7300	KNORR	SN7032-K010150	EFR7305
KNORR	SN7028AT	EFR7300	KNORR	SN7032-K010152	EFR7301
KNORR	SN7029	EFR7300	KNORR	SN7032-K082482	EFR7305
KNORR	SN7030	EFR7305	KNORR	SN7032-K082486	EFR7305
KNORR	SN7030AT	EFR7305	KNORR	SN7032-Z0010292	EFR7305
KNORR	SN7030-II39516F	EFR7301	KNORR	SN7032-Z0010294	EFR7305
KNORR	SN7030-K000203	EFR7301	KNORR	SN7034	EFR7305
KNORR	SN7030-K000205	EFR7301	KNORR	SN7038	EFR7301
KNORR	SN7030-K000307	EFR7301	KNORR	SN7038AT	EFR7301
KNORR	SN7030-K002358	EFR7301	KNORR	SN7039	EFR7301
KNORR	SN7030-K002360	EFR7301	KNORR	SN7040	EFR7302
KNORR	SN7030-K002362	EFR7305	KNORR	SN7040RC	EFR7302
KNORR	SN7030-K002364	EFR7305	KNORR	SN7041	EFR7320
KNORR	SN7030-K007089	EFR7301	KNORR	SN7042	EFR7333
KNORR	SN7030-K007091	EFR7301	KNORR	SN7045	EFR7302
KNORR	SN7030-K007093	EFR7305	KNORR	SN7047	EFR7304
KNORR	SN7030-K007095	EFR7301	KNORR	SN7049	EFR7305
KNORR	SN7030-K007097	EFR7305	KNORR	SN7050	EFR7303
KNORR	SN7030-K007099	EFR7305	KNORR	SN7050RC	EFR7303
KNORR	SN7030-K082474	EFR7305	KNORR	SN7051	EFR7321
KNORR	SN7030-K082478	EFR7305	KNORR	SN7052	EFR7332
KNORR	SN7030-Z000724	EFR7305	KNORR	SN7055	EFR7303
KNORR	SN7030-Z000726	EFR7305	KNORR	SN7057	EFR7305
KNORR	SN7031	EFR7305	KNORR	SN7059	EFR7304
KNORR	SN7031-II39538F	EFR7301	KNORR	SN7066	EFR7300
KNORR	SN7031-K002350	EFR7305	KNORR	SN7067	EFR7300
KNORR	SN7031-K002352	EFR7305	KNORR	SN7076	EFR7301
KNORR	SN7031-K007188	EFR7305	KNORR	SN7077	EFR7301
KNORR	SN7031-K007190	EFR7305	KNORR	SN7080	EFR7302
KNORR	SN7031-K010148	EFR7305	KNORR	SN7080AT	EFR7302
KNORR	SN7031-K010898	EFR7301	KNORR	SN7081	EFR7304
KNORR	SN7031-K010900	EFR7301	KNORR	SN7081AT	EFR7304
KNORR	SN7031-K010902	EFR7301	KNORR	SN7083	EFR7310
KNORR	SN7031-Z0010002	EFR7305	KNORR	SN7083AT	EFR7310
KNORR	SN7031-Z0010004	EFR7305	KNORR	SN7084	EFR7302
KNORR	SN7032	EFR7305	KNORR	SN7085	EFR7302
KNORR	SN7032-II39540F	EFR7305	KNORR	SN7086	EFR7310
KNORR	SN7032-K000207	EFR7301	KNORR	SN7090	EFR7303
KNORR	SN7032-K000209	EFR7301	KNORR	SN7090AT	EFR7303

Les correspondances de références ont pour seul objectif d'aider la recherche de référence

Cross references are there for the sole purpose of helping the reference search

CORRESPONDANCES DES REFERENCES CROSS REFERENCE LIST

MARQUE/MAKER	REF/PN OES	REF/PN	MARQUE/MAKER	REF/PN OES	REF/PN
KNORR	SN7091	EFR7305	KNORR	SN7151	EFR7303
KNORR	SN7091AT	EFR7305	KNORR	SN7152	EFR7301
KNORR	SN7093	EFR7311	KNORR	SN7153	EFR7303
KNORR	SN7093AT	EFR7311	KNORR	SN7154	EFR7305
KNORR	SN7094	EFR7303	KNORR	SN7154AT	EFR7305
KNORR	SN7095	EFR7303	KNORR	SN7156	EFR7303
KNORR	SN7096	EFR7311	KNORR	SN7157	EFR7301
KNORR	SN7101	EFR7300	KNORR	SN7160	EFR7310
KNORR	SN7102	EFR7302	KNORR	SN7160AT	EFR7310
KNORR	SN7105	EFR7300	KNORR	SN7163	EFR7300
KNORR	SN7106	EFR7300	KNORR	SN7164	EFR7302
KNORR	SN7107	EFR7310	KNORR	SN7165	EFR7302
KNORR	SN7108	EFR7302	KNORR	SN7166	EFR7300
KNORR	SN7109	EFR7304	KNORR	SN7167	EFR7328
KNORR	SN7111	EFR7301	KNORR	SN7167AT	EFR7328
KNORR	SN7112	EFR7303	KNORR	SN7168	EFR7308
KNORR	SN7115	EFR7301	KNORR	SN7168AT	EFR7308
KNORR	SN7116	EFR7301	KNORR	SN7169	EFR7300
KNORR	SN7117	EFR7311	KNORR	SN7169AT	EFR7300
KNORR	SN7118	EFR7303	KNORR	SN7170	EFR7311
KNORR	SN7119	EFR7305	KNORR	SN7170AT	EFR7311
KNORR	SN7122	EFR7310	KNORR	SN7173	EFR7301
KNORR	SN7123	EFR7302	KNORR	SN7174	EFR7303
KNORR	SN7124	EFR7300	KNORR	SN7175	EFR7303
KNORR	SN7125	EFR7326	KNORR	SN7176	EFR7301
KNORR	SN7126	EFR7330	KNORR	SN7177	EFR7329
KNORR	SN7126RC	EFR7326	KNORR	SN7177AT	EFR7329
KNORR	SN7127	EFR7310	KNORR	SN7178	EFR7309
KNORR	SN7128	EFR7308	KNORR	SN7178AT	EFR7309
KNORR	SN7129	EFR7300	KNORR	SN7179	EFR7301
KNORR	SN7132	EFR7311	KNORR	SN7179AT	EFR7301
KNORR	SN7133	EFR7303	KNORR	SN7183	EFR7302
KNORR	SN7134	EFR7301	KNORR	SN7185	EFR7301
KNORR	SN7135	EFR7327	KNORR	SN7185RC	EFR7301
KNORR	SN7136	EFR7331	KNORR	SN7186	EFR7303
KNORR	SN7136RC	EFR7327	KNORR	SN7186RC	EFR7303
KNORR	SN7137	EFR7311	KNORR	SN7187	EFR7303
KNORR	SN7138	EFR7309	KNORR	SN7187RC	EFR7303
KNORR	SN7139	EFR7301	KNORR	SN7188RC	EFR7311
KNORR	SN7140	EFR7302	KNORR	SN7189	EFR7301
KNORR	SN7141	EFR7302	KNORR	SN7189RC	EFR7301
KNORR	SN7142	EFR7300	KNORR	SN7193	EFR7303
KNORR	SN7143	EFR7302	KNORR	SN7195	EFR7300
KNORR	SN7144	EFR7304	KNORR	SN7195RC	EFR7300
KNORR	SN7144AT	EFR7304	KNORR	SN7196	EFR7302
KNORR	SN7146	EFR7302	KNORR	SN7196RC	EFR7302
KNORR	SN7147	EFR7300	KNORR	SN7197	EFR7302
KNORR	SN7150	EFR7303	KNORR	SN7197RC	EFR7302

Les correspondances de références ont pour seul objectif d'aider la recherche de référence

Cross references are there for the sole purpose of helping the reference search

CORRESPONDANCES DES REFERENCES CROSS REFERENCE LIST

MARQUE/MAKER	REF/PN OES	REF/PN	MARQUE/MAKER	REF/PN OES	REF/PN
KNORR	SN7198RC	EFR7310	KNORR	SN7240	EFR7310
KNORR	SN7199	EFR7300	KNORR	SN7241	EFR7301
KNORR	SN7199RC	EFR7300	KNORR	SN7241RC	EFR7301
KNORR	SN7200RC	EFR7305	KNORR	SN7242RC	EFR7305
KNORR	SN7201	EFR7305	KNORR	SN7247	EFR7302
KNORR	SN7201RC	EFR7305	KNORR	SN7248	EFR7302
KNORR	SN7202	EFR7305	KNORR	SN7249	EFR7300
KNORR	SN7202RC	EFR7305	KNORR	SN7250	EFR7311
KNORR	SN7203	EFR7303	KNORR	SN7251	EFR7300
KNORR	SN7203RC	EFR7303	KNORR	SN7251RC	EFR7300
KNORR	SN7204	EFR7309	KNORR	SN7252RC	EFR7304
KNORR	SN7204RC	EFR7309	KNORR	SN7257	EFR7303
KNORR	SN7205	EFR7329	KNORR	SN7258	EFR7303
KNORR	SN7205RC	EFR7329	KNORR	SN7259	EFR7301
KNORR	SN7206	EFR7311	KNORR	SN7260	EFR7302
KNORR	SN7206RC	EFR7311	KNORR	SN7263	EFR7300
KNORR	SN7207	EFR7311	KNORR	SN7263AT	EFR7300
KNORR	SN7207RC	EFR7311	KNORR	SN7264	EFR7321
KNORR	SN7208	EFR7321	KNORR	SN7264AT	EFR7321
KNORR	SN7208RC	EFR7321	KNORR	SN7264RC	EFR7321
KNORR	SN7209	EFR7327	KNORR	SN7265	EFR7337
KNORR	SN7209RC	EFR7327	KNORR	SN7265RC	EFR7337
KNORR	SN7210RC	EFR7304	KNORR	SN7266	EFR7304
KNORR	SN7211	EFR7304	KNORR	SN7267	EFR7310
KNORR	SN7211RC	EFR7304	KNORR	SN7268	EFR7302
KNORR	SN7212	EFR7304	KNORR	SN7269	EFR7302
KNORR	SN7212RC	EFR7304	KNORR	SN7270	EFR7303
KNORR	SN7213	EFR7302	KNORR	SN7273	EFR7301
KNORR	SN7213RC	EFR7302	KNORR	SN7273AT	EFR7301
KNORR	SN7214	EFR7308	KNORR	SN7274	EFR7320
KNORR	SN7214RC	EFR7308	KNORR	SN7274AT	EFR7320
KNORR	SN7215	EFR7328	KNORR	SN7274RC	EFR7320
KNORR	SN7215RC	EFR7328	KNORR	SN7275	EFR7336
KNORR	SN7216	EFR7310	KNORR	SN7275RC	EFR7336
KNORR	SN7216RC	EFR7310	KNORR	SN7276	EFR7305
KNORR	SN7217	EFR7310	KNORR	SN7277	EFR7311
KNORR	SN7217RC	EFR7310	KNORR	SN7278	EFR7303
KNORR	SN7218	EFR7320	KNORR	SN7279	EFR7303
KNORR	SN7218RC	EFR7320	KNORR	SN7280	EFR7304
KNORR	SN7219	EFR7326	KNORR	SN7281	EFR7300
KNORR	SN7219RC	EFR7326	KNORR	SN7282	EFR7300
KNORR	SN7227	EFR7302	KNORR	SN7283	EFR7300
KNORR	SN7228	EFR7336	KNORR	SN7284	EFR7308
KNORR	SN7229	EFR7302	KNORR	SN7285	EFR7304
KNORR	SN7234	EFR7302	KNORR	SN7287	EFR7308
KNORR	SN7237	EFR7303	KNORR	SN7288	EFR7302
KNORR	SN7238	EFR7337	KNORR	SN7289	EFR7332
KNORR	SN7239	EFR7303	KNORR	SN7289RC	EFR7332

Les correspondances de références ont pour seul objectif d'aider la recherche de référence

Cross references are there for the sole purpose of helping the reference search

CORRESPONDANCES DES REFERENCES CROSS REFERENCE LIST

MARQUE/MAKER	REF/PN OES	REF/PN	MARQUE/MAKER	REF/PN OES	REF/PN
KNORR	SN7290	EFR7305	KNORR	SN7350	EFR7303
KNORR	SN7291	EFR7301	KNORR	SN7351	EFR7303
KNORR	SN7292	EFR7301	KNORR	SN7356	EFR7332
KNORR	SN7293	EFR7301	KNORR	SN7357	EFR7303
KNORR	SN7294	EFR7309	KNORR	SN7358	EFR7303
KNORR	SN7295	EFR7305	KNORR	SN7361	EFR7304
KNORR	SN7297	EFR7309	KNORR	SN7362	EFR7300
KNORR	SN7298	EFR7303	KNORR	SN7366	EFR7343
KNORR	SN7299	EFR7333	KNORR	SN7366RC	EFR7343
KNORR	SN7299RC	EFR7333	KNORR	SN7367	EFR7336
KNORR	SN7300	EFR7301	KNORR	SN7371	EFR7305
KNORR	SN7300RC	EFR7301	KNORR	SN7372	EFR7301
KNORR	SN7301	EFR7303	KNORR	SN7376	EFR7342
KNORR	SN7301RC	EFR7303	KNORR	SN7376RC	EFR7342
KNORR	SN7304	EFR7304	KNORR	SN7377	EFR7337
KNORR	SN7306	EFR7304	KNORR	SN7380	EFR7308
KNORR	SN7307	EFR7336	KNORR	SN7381	EFR7310
KNORR	SN7308	EFR7303	KNORR	SN7390	EFR7309
KNORR	SN7308RC	EFR7303	KNORR	SN7391	EFR7311
KNORR	SN7309	EFR7342	KNORR	SN7399	EFR7336
KNORR	SN7309AT	EFR7343	KNORR	SN7400	EFR7310
KNORR	SN7310	EFR7300	KNORR	SN7401	EFR7304
KNORR	SN7310RC	EFR7300	KNORR	SN7401DC	EFR7304
KNORR	SN7311	EFR7302	KNORR	SN7402	EFR7300
KNORR	SN7311RC	EFR7302	KNORR	SN7402AT	EFR7300
KNORR	SN7314	EFR7305	KNORR	SN7403	EFR7333
KNORR	SN7316	EFR7305	KNORR	SN7403AT	EFR7333
KNORR	SN7317	EFR7337	KNORR	SN7405	EFR7302
KNORR	SN7318	EFR7302	KNORR	SN7406	EFR7300
KNORR	SN7318RC	EFR7302	KNORR	SN7409	EFR7337
KNORR	SN7319	EFR7343	KNORR	SN7410	EFR7311
KNORR	SN7319AT	EFR7342	KNORR	SN7411	EFR7305
KNORR	SN7322	EFR7303	KNORR	SN7411DC	EFR7305
KNORR	SN7322RC	EFR7303	KNORR	SN7412	EFR7301
KNORR	SN7323	EFR7302	KNORR	SN7412AT	EFR7301
KNORR	SN7325	EFR7336	KNORR	SN7413	EFR7332
KNORR	SN7329	EFR7302	KNORR	SN7413AT	EFR7332
KNORR	SN7332	EFR7302	KNORR	SN7415	EFR7303
KNORR	SN7332RC	EFR7302	KNORR	SN7416	EFR7301
KNORR	SN7333	EFR7303	KNORR	SN7420	EFR7302
KNORR	SN7334	EFR7303	KNORR	SN7423	EFR7300
KNORR	SN7335	EFR7337	KNORR	SN7424	EFR7300
KNORR	SN7339	EFR7303	KNORR	SN7425	EFR7310
KNORR	SN7340	EFR7302	KNORR	SN7428	EFR7300
KNORR	SN7341	EFR7302	KNORR	SN7429	EFR7300
KNORR	SN7346	EFR7333	KNORR	SN7429AT	EFR7300
KNORR	SN7347	EFR7302	KNORR	SN7429RC	EFR7300
KNORR	SN7348	EFR7302	KNORR	SN7430	EFR7303

Les correspondances de références ont pour seul objectif d'aider la recherche de référence

Cross references are there for the sole purpose of helping the reference search

CORRESPONDANCES DES REFERENCES CROSS REFERENCE LIST

MARQUE/MAKER	REF/PN OES	REF/PN	MARQUE/MAKER	REF/PN OES	REF/PN
KNORR	SN7433	EFR7301	KNORR	SSB70003	2924401
KNORR	SN7434	EFR7301	KNORR	SSB70003	2927801
KNORR	SN7435	EFR7311	KNORR	SSB70003	2927802
KNORR	SN7438	EFR7301	KNORR	SSB70003	FCV4418PTS
KNORR	SN7439	EFR7301	KNORR	ST7001	EFR7354
KNORR	SN7439AT	EFR7301	KNORR	ST7002	EFR7354
KNORR	SN7439RC	EFR7301	KNORR	ST7003RC	EFR7354
KNORR	SN7440RC	EFR7301	KNORR	ST7006	EFR7354
KNORR	SN7443	EFR7302	KNORR	ST7007	EFR7354
KNORR	SN7443AT	EFR7302	KNORR	ST7011	EFR7355
KNORR	SN7446	EFR7302	KNORR	ST7012	EFR7355
KNORR	SN7450RC	EFR7300	KNORR	ST7013RC	EFR7355
KNORR	SN7453	EFR7303	KNORR	ST7016	EFR7355
KNORR	SN7453AT	EFR7303	KNORR	ST7017	EFR7355
KNORR	SN7456	EFR7303	KNORR	ST7020	EFR7354
KNORR	SN7460	EFR7310	KNORR	ST7021	EFR7354
KNORR	SN7461	EFR7304	KNORR	ST7030	EFR7355
KNORR	SN7462	EFR7310	KNORR	ST7031	EFR7355
KNORR	SN7465	EFR7310	KNORR	Z0001401	EFR6300
KNORR	SN7468	EFR7343	KNORR	Z0001402	EFR6301
KNORR	SN7470	EFR7311	KNORR	Z0001651	EFR7302
KNORR	SN7471	EFR7305	KNORR	Z0001652	EFR7303
KNORR	SN7472	EFR7311	KNORR	Z000276	EFR7302
KNORR	SN7475	EFR7311	KNORR	Z000277	EFR7303
KNORR	SN7478	EFR7342	KNORR	Z000611	EFR6304
KNORR	SN7501	EFR7310	KNORR	Z000612	EFR6305
KNORR	SN7511	EFR7311	KNORR	Z000652	EFR7302
KNORR	SN7520	EFR7333	KNORR	Z000652AT	EFR7302
KNORR	SN7523	EFR7302	KNORR	Z000652AT	EFR7302
KNORR	SN7529	EFR7310	KNORR	Z000653	EFR7303
KNORR	SN7530	EFR7332	KNORR	Z000653AT	EFR7303
KNORR	SN7533	EFR7303	KNORR	Z000653AT	EFR7303
KNORR	SN7539	EFR7311	KNORR	Z000723	EFR7304
KNORR	SN7540	EFR7310	KNORR	Z000723AT	EFR7304
KNORR	SN7545	EFR7302	KNORR	Z000723DC	EFR7304
KNORR	SN7546	EFR7300	KNORR	Z000724	EFR7305
KNORR	SN7548	EFR7302	KNORR	Z000724AT	EFR7305
KNORR	SN7550	EFR7311	KNORR	Z000724DC	EFR7305
KNORR	SN7555	EFR7303	KNORR	Z000725	EFR7304
KNORR	SN7556	EFR7301	KNORR	Z000726	EFR7305
KNORR	SN7558	EFR7303	KNORR	Z0009751	EFR7308
KNORR	SSB70001	2920200604	KNORR	Z0009752	EFR7309
KNORR	SSB70001	2924401	KNORR	Z0009801	EFR7312
KNORR	SSB70001	2927801	KNORR	Z0009802	EFR7313
KNORR	SSB70001	2927802	KNORR	Z000981	EFR7312
KNORR	SSB70001	FCV4418PTS	KNORR	Z000982	EFR7313
KNORR	SSB70002	2927801	KNORR	Z0010001	EFR7304
KNORR	SSB70003	2920200604	KNORR	Z0010002	EFR7305

Les correspondances de références ont pour seul objectif d'aider la recherche de référence

Cross references are there for the sole purpose of helping the reference search

CORRESPONDANCES DES REFERENCES CROSS REFERENCE LIST

MARQUE/MAKER	REF/PN OES	REF/PN	MARQUE/MAKER	REF/PN OES	REF/PN
KNORR	Z0010003	EFR7304	KNORR	Z0013572	EFR7303
KNORR	Z0010004	EFR7305	KNORR	Z0013572AT	EFR7303
KNORR	Z0010291	EFR7304	KNORR	Z0013591	EFR7310
KNORR	Z0010292	EFR7305	KNORR	Z0013591AT	EFR7310
KNORR	Z0010293	EFR7304	KNORR	Z0013592	EFR7311
KNORR	Z0010294	EFR7305	KNORR	Z0013592AT	EFR7311
KNORR	Z0010341	EFR7304	KNORR	Z0013611	EFR7302
KNORR	Z0010342	EFR7305	KNORR	Z0013612	EFR7303
KNORR	Z0010671	EFR6300	KNORR	Z0013631	EFR7320
KNORR	Z0010672	EFR6301	KNORR	Z0013632	EFR7321
KNORR	Z0010911	EFR7300	KNORR	Z0014981	EFR7306
KNORR	Z0010911AT	EFR7300	KNORR	Z0014982	EFR7307
KNORR	Z0010911DC	EFR7300	KNORR	Z0015241	EFR7300
KNORR	Z0010911SX	EFR7300	KNORR	Z0015242	EFR7301
KNORR	Z0010912	EFR7301	KNORR	Z0015261	EFR7304
KNORR	Z0010912AT	EFR7301	KNORR	Z0015262	EFR7305
KNORR	Z0010912DC	EFR7301	KNORR	Z001548	CAC004
KNORR	Z0010912SX	EFR7301	KNORR	Z0015711	EFR7303
KNORR	Z0010913	EFR7300	KNORR	Z0015712	EFR7302
KNORR	Z0010914	EFR7301	KNORR	Z0015731	EFR7302
KNORR	Z0010961	EFR7316	KNORR	Z0015732	EFR7303
KNORR	Z0010962	EFR7317	KNORR	Z0015751	EFR7310
KNORR	Z0011201	EFR7302	KNORR	Z0015752	EFR7311
KNORR	Z0011202	EFR7303	KNORR	Z0016511	EFR6300
KNORR	Z0011451	EFR6300	KNORR	Z0016511AT	EFR6300
KNORR	Z0011452	EFR6301	KNORR	Z0016512	EFR6301
KNORR	Z0011471	EFR7302	KNORR	Z0016512AT	EFR6301
KNORR	Z0011471AT	EFR7302	KNORR	Z0016513	EFR6300
KNORR	Z0011472	EFR7303	KNORR	Z0016514	EFR6301
KNORR	Z0011472AT	EFR7303	KNORR	Z0016514AT	EFR6301
KNORR	Z0011491	EFR7300	KNORR	Z0016571	EFR7300
KNORR	Z0011491AT	EFR7300	KNORR	Z0016571AT	EFR7300
KNORR	Z0011492	EFR7301	KNORR	Z0016572	EFR7301
KNORR	Z0011492AT	EFR7301	KNORR	Z0016572AT	EFR7301
KNORR	Z0011521	EFR7310	KNORR	Z0017261	EFR7333
KNORR	Z0011522	EFR7311	KNORR	Z0017261AT	EFR7333
KNORR	Z0011522	EFR7311	KNORR	Z0017262	EFR7332
KNORR	Z0011541	EFR6300	KNORR	Z0017262AT	EFR7332
KNORR	Z0011542	EFR6301	KNORR	Z0017521	EFR7300
KNORR	Z0011561	EFR6302	KNORR	Z0017521AT	EFR7300
KNORR	Z0011561AT	EFR6302	KNORR	Z0017522	EFR7301
KNORR	Z0011562	EFR6303	KNORR	Z0017522AT	EFR7301
KNORR	Z0011581	EFR7302	KNORR	Z0017523	EFR7300
KNORR	Z0011582	EFR7303	KNORR	Z0017523AT	EFR7300
KNORR	Z0011891	EFR6307	KNORR	Z0017524	EFR7301
KNORR	Z0011892	EFR6306	KNORR	Z0017524AT	EFR7301
KNORR	Z0013571	EFR7302	KNORR	Z001761	EFR7333
KNORR	Z0013571AT	EFR7302	KNORR	Z001762	EFR7332

Les correspondances de références ont pour seul objectif d'aider la recherche de référence

Cross references are there for the sole purpose of helping the reference search

CORRESPONDANCES DES REFERENCES CROSS REFERENCE LIST

MARQUE/MAKER	REF/PN OES	REF/PN	MARQUE/MAKER	REF/PN OES	REF/PN
KNORR	Z0017671	EFR6300	KNORR	Z0021141SC	EFR7314
KNORR	Z0017672	EFR6301	KNORR	Z0021142	EFR7315
KNORR	Z0017891	EFR6300	KNORR	Z0021142AT	EFR7315
KNORR	Z0017892	EFR6301	KNORR	Z0021142SAT	EFR7315
KNORR	Z0017951	EFR7302	KNORR	Z0021142SC	EFR7315
KNORR	Z0017952	EFR7303	KNORR	Z0021161	EFR7300
KNORR	Z0017971	EFR6300	KNORR	Z0021162	EFR7301
KNORR	Z0017972	EFR6301	KNORR	Z0021181	EFR7306
KNORR	Z002016	09.8573.10	KNORR	Z0021181AT	EFR7306
KNORR	Z002016	93101400	KNORR	Z0021182	EFR7307
KNORR	Z002016	FCR189A	KNORR	Z0021182AT	EFR7307
KNORR	Z0021001	EFR7302	KNORR	Z0021221	EFR7314
KNORR	Z0021001AT	EFR7302	KNORR	Z0021222	EFR7315
KNORR	Z0021002	EFR7303	KNORR	Z0021241	EFR7316
KNORR	Z0021002AT	EFR7303	KNORR	Z0021241AT	EFR7316
KNORR	Z0021021	EFR7302	KNORR	Z0021242	EFR7317
KNORR	Z0021021AT	EFR7302	KNORR	Z0021242AT	EFR7317
KNORR	Z0021022	EFR7303	KNORR	Z0021243	EFR7316
KNORR	Z0021022AT	EFR7303	KNORR	Z0021244	EFR7317
KNORR	Z0021041	EFR7302	KNORR	Z0021261	EFR7310
KNORR	Z0021041AT	EFR7302	KNORR	Z0021261AT	EFR7310
KNORR	Z0021042	EFR7303	KNORR	Z0021262	EFR7311
KNORR	Z0021042AT	EFR7303	KNORR	Z0021262AT	EFR7311
KNORR	Z0021043	EFR7302	KNORR	Z0021281	EFR7302
KNORR	Z0021044	EFR7303	KNORR	Z0021281AT	EFR7302
KNORR	Z0021061	EFR7300	KNORR	Z0021282	EFR7303
KNORR	Z0021062	EFR7301	KNORR	Z0021282AT	EFR7303
KNORR	Z0021063	EFR7300	KNORR	Z0021301	EFR7316
KNORR	Z0021064	EFR7301	KNORR	Z0021302	EFR7317
KNORR	Z0021065	EFR7300	KNORR	Z002539	CAC009
KNORR	Z0021066	EFR7301	KNORR	Z0029181	EFR7300
KNORR	Z0021081	EFR7310	KNORR	Z0029182	EFR7301
KNORR	Z0021081AT	EFR7310	KNORR	Z0029183	EFR7300
KNORR	Z0021082	EFR7311	KNORR	Z0029184	EFR7301
KNORR	Z0021082AT	EFR7311	KOGEL	28089103	DF713889
KNORR	Z0021103	EFR7314	KOGEL	6500336	W0760SA
KNORR	Z0021103AT	EFR7314	KOGEL	6500488	2933601
KNORR	Z0021104	EFR7315	KOGEL	6500509	CAC009
KNORR	Z0021104AT	EFR7315	KOGEL	6500614	09.A594.20
KNORR	Z0021121	EFR7316	KOGEL	6500614	93126900
KNORR	Z0021121AT	EFR7316	KOGEL	6500614	FCR252A
KNORR	Z0021122	EFR7317	KOGEL	6500700	CAC019
KNORR	Z0021122AT	EFR7317	KOGEL	6500701	EFR6006
KNORR	Z0021123	EFR7316	KOGEL	6500702	EFR6007
KNORR	Z0021124	EFR7317	KOGEL	6604984	EFR7704
KNORR	Z0021141	EFR7314	KOGEL	6604985	EFR7705
KNORR	Z0021141AT	EFR7314	KOGEL	6607394	09.E162.10
KNORR	Z0021141SAT	EFR7314	KOGEL	6607394	93308700

Les correspondances de références ont pour seul objectif d'aider la recherche de référence

Cross references are there for the sole purpose of helping the reference search

CORRESPONDANCES DES REFERENCES CROSS REFERENCE LIST

MARQUE/MAKER	REF/PN OES	REF/PN	MARQUE/MAKER	REF/PN OES	REF/PN
KOGEL	6607394	FCR358A	MAN	36508046022	EFR7317
KRONE	505816336	W0760SA	MAN	36508046023	EFR7302
KRONE	5058163360	W0760SA	MAN	36508046024	EFR7303
KRONE	515074267	W0610SA	MAN	36508046025	EFR7310
KRONE	550017646	FCV4420B	MAN	36508046026	EFR7311
KRONE	550018797	29xxxxx	MAN	36508046027	EFR7306
KRONE	5816336	W0760SA	MAN	36508046028	EFR7307
KRONE	58163360	W0760SA	MAN	36508046031	EFR7314
KRONE	719001019	W0610SA	MAN	36508046032	EFR7315
LANGENDORF	1225588	W0760SA	MAN	36508046033	EFR7302
LECINENA	120015000270	EFR6308	MAN	36508046034	EFR7303
LECINENA	120015000271	EFR6309	MAN	36508046043	EFR7310
LECINENA	412017	EFR6300	MAN	36508046044	EFR7311
LECINENA	412018	EFR6301	MAN	36508046047	EFR7316
LECINENA	412023	EFR7302	MAN	36508046048	EFR7317
LECINENA	412024	EFR7303	MAN	6017718107	CAC040
LECINENA	412027	EFR7303	MAN	81357006111	09.9301.10
LECINENA	412028	EFR7302	MAN	81357006111	09.9467.10
LECINENA	5820114	CAC016	MAN	81357006111	93087000
LECINENA	5820132	EFR7692	MAN	81357006111	93087100
LECINENA	5820135	EFR7693	MAN	81357006111	DF70002
LEYLAND	EXABRF687	DF713891	MAN	81357006111	FCR161A
LEYLAND	LBMDP5076	2912405	MAN	81357006111	FCR215A
LEYLAND	LBMDP5076	CVP024K	MAN	81501100009	09.7320.10
LIEBHERR	10326494	2933601	MAN	81501100009	93071800
MACK	261112999746VT	CAC018	MAN	81501100009	FCR144A
MAN	11119742	EFR7311	MAN	81501100010	09.7164.10
MAN	11119743	EFR7310	MAN	81501100010	93085300
MAN	14006585	EFR5009	MAN	81501100010	FCR143A
MAN	1505370	EFR5008	MAN	81506006011	EFR7636
MAN	1505371	EFR5009	MAN	81506006012	EFR7637
MAN	35403112182	CAC011	MAN	81506006015	EFR7636
MAN	35503075700	CAC040	MAN	81506006016	EFR7637
MAN	35503109496	CAC014	MAN	81508006011	2905503
MAN	35503109577	EFR7696	MAN	81508020010	09.7164.10
MAN	35503109583	EFR7697	MAN	81508020010	93085300
MAN	35503120460R	EFR7716	MAN	81508020010	FCR143A
MAN	35503120477R	EFR7717	MAN	81508026013	EFR7632
MAN	35504157917	EFR7716	MAN	81508026014	EFR7633
MAN	35504157923	EFR7717	MAN	81508026016	CAC030
MAN	35504208415	EFR7717	MAN	81508026017	CAC014
MAN	35504208421	EFR7717	MAN	81508026020	CAC014
MAN	36508030000	09.B325.40	MAN	81508026021	CAC014
MAN	36508030000	93086800	MAN	81508026022	CAC029
MAN	36508030000	FCR168A	MAN	81508026024	CAC011
MAN	36508046001	EFR7302	MAN	81508026025	CAC012
MAN	36508046002	EFR7303	MAN	81508026027	CAC011
MAN	36508046021	EFR7316	MAN	81508030001	09.7320.10

Les correspondances de références ont pour seul objectif d'aider la recherche de référence

Cross references are there for the sole purpose of helping the reference search

CORRESPONDANCES DES REFERENCES CROSS REFERENCE LIST

MARQUE/MAKER	REF/PN OES	REF/PN	MARQUE/MAKER	REF/PN OES	REF/PN
MAN	81508030001	93071800	MAN	81508030033	09.9435.10
MAN	81508030001	FCR144A	MAN	81508030033	93087200
MAN	81508030009	09.7320.10	MAN	81508030033	DF70001
MAN	81508030009	93071800	MAN	81508030033	FCR214A
MAN	81508030009	FCR144A	MAN	81508030034	09.9435.10
MAN	81508030010	09.7164.10	MAN	81508030034	93087200
MAN	81508030010	93085300	MAN	81508030034	DF70001
MAN	81508030010	FCR143A	MAN	81508030034	FCR214A
MAN	81508030014	09.7320.10	MAN	81508030035	93087200
MAN	81508030014	93071800	MAN	81508030035	DF70001
MAN	81508030014	FCR144A	MAN	81508030035	FCR214A
MAN	81508030015	09.7320.10	MAN	81508030036	09.9435.10
MAN	81508030015	93071800	MAN	81508030036	93087200
MAN	81508030015	FCR144A	MAN	81508030036	DF70001
MAN	81508030020	09.A461.10	MAN	81508030036	FCR214A
MAN	81508030020	93086900	MAN	81508030038	09.9435.10
MAN	81508030020	FCR147A	MAN	81508030038	93087200
MAN	81508030021	09.9467.10	MAN	81508030038	DF70001
MAN	81508030021	93087000	MAN	81508030038	FCR214A
MAN	81508030021	DF70002	MAN	81508030039	93127700
MAN	81508030021	FCR215A	MAN	81508030039	FCR216A
MAN	81508030022	09.8172.10	MAN	81508030040	09.9435.10
MAN	81508030022	93085500	MAN	81508030040	93087200
MAN	81508030022	FCR148A	MAN	81508030040	DF70001
MAN	81508030023	09.9435.10	MAN	81508030040	FCR214A
MAN	81508030023	93087200	MAN	81508030041	09.9467.10
MAN	81508030023	DF70001	MAN	81508030041	93087000
MAN	81508030023	FCR214A	MAN	81508030041	DF70002
MAN	81508030024	09.8173.10	MAN	81508030041	FCR215A
MAN	81508030024	93085400	MAN	81508030042	09.B564.10
MAN	81508030024	FCR146A	MAN	81508030042	93138000
MAN	81508030026	09.8173.10	MAN	81508030042	FCR330A
MAN	81508030026	93085400	MAN	81508030044	93191200
MAN	81508030026	FCR146A	MAN	81508030044	FCR331A
MAN	81508030027	09.A461.10	MAN	81508030046	09.9435.10
MAN	81508030027	93086900	MAN	81508030046	93087200
MAN	81508030027	FCR147A	MAN	81508030046	DF70001
MAN	81508030028	09.9301.10	MAN	81508030046	FCR214A
MAN	81508030028	09.9467.10	MAN	81508030047	09.9467.10
MAN	81508030028	93087000	MAN	81508030047	93087000
MAN	81508030028	93087100	MAN	81508030047	DF70002
MAN	81508030028	DF70002	MAN	81508030047	FCR215A
MAN	81508030028	FCR161A	MAN	81508030048	09.9301.10
MAN	81508030028	FCR215A	MAN	81508030048	09.9467.10
MAN	81508030031	09.9435.10	MAN	81508030048	93087000
MAN	81508030031	93087200	MAN	81508030048	93087100
MAN	81508030031	DF70001	MAN	81508030048	DF70002
MAN	81508030031	FCR214A	MAN	81508030048	FCR161A

Les correspondances de références ont pour seul objectif d'aider la recherche de référence

Cross references are there for the sole purpose of helping the reference search

CORRESPONDANCES DES REFERENCES CROSS REFERENCE LIST

MARQUE/MAKER	REF/PN OES	REF/PN	MARQUE/MAKER	REF/PN OES	REF/PN
MAN	81508030048	FCR215A	MAN	8150804471	EFR6300
MAN	81508030050	09.A461.10	MAN	8150804472	EFR6301
MAN	81508030050	93086900	MAN	81508045087	2903005392
MAN	81508030050	FCR147A	MAN	81508045088	2903005392
MAN	81508030053	09.B564.10	MAN	81508045088	2905301
MAN	81508030053	93138000	MAN	81508046011	EFR7600
MAN	81508030053	FCR330A	MAN	81508046012	EFR7601
MAN	81508030054	09.B562.10	MAN	81508046017	EFR5008
MAN	81508030054	93143100	MAN	81508046018	EFR5009
MAN	81508030054	FCR272A	MAN	81508046021	EFR7632
MAN	81508030057	09.A461.10	MAN	81508046022	EFR7633
MAN	81508030057	93086900	MAN	81508046028	2905503
MAN	81508030057	FCR147A	MAN	81508046040	EFR7635
MAN	81508030061	09.8172.10	MAN	81508046041	EFR7634
MAN	81508030061	93085500	MAN	81508046042	EFR7635
MAN	81508030061	FCR148A	MAN	81508046043	EFR7634
MAN	81508030062	09.B562.10	MAN	81508046045	EFR7600
MAN	81508030062	93143100	MAN	81508046046	EFR7601
MAN	81508030062	FCR272A	MAN	81508046048	EFR5009
MAN	81508030063	09.B562.10	MAN	81508046049	EFR5008
MAN	81508030063	93143100	MAN	81508046051	EFR6300
MAN	81508030063	FCR272A	MAN	81508046052	EFR6301
MAN	81508033041	09.9467.10	MAN	81508046053	EFR6300
MAN	81508033041	93087000	MAN	81508046054	EFR6301
MAN	81508033041	DF70002	MAN	81508046056	EFR6301
MAN	81508033041	FCR215A	MAN	81508046057	EFR6300
MAN	8150804365	EFR6300	MAN	81508046061	EFR7600
MAN	8150804366	EFR6301	MAN	81508046062	EFR7601
MAN	8150804418	EFR5300	MAN	81508046063	EFR7600
MAN	8150804419	EFR5301	MAN	81508046064	EFR7601
MAN	8150804420	EFR5300	MAN	81508046065	EFR7632
MAN	8150804421	EFR5301	MAN	81508046066	EFR7633
MAN	8150804434	EFR7303	MAN	81508046067	EFR7636
MAN	8150804435	EFR7302	MAN	81508046068	EFR7637
MAN	8150804447	EFR6300	MAN	81508046070	EFR5007
MAN	8150804448	EFR6301	MAN	81508046071	EFR5006
MAN	8150804449	EFR7336	MAN	81508046072	EFR5007
MAN	8150804451	EFR7336	MAN	81508046073	EFR5006
MAN	8150804453	EFR7302	MAN	81508046078	EFR7635
MAN	8150804454	EFR7303	MAN	81508046079	EFR7634
MAN	8150804459	EFR7302	MAN	81508046081	EFR7632
MAN	8150804460	EFR7303	MAN	81508046082	EFR7633
MAN	8150804461	EFR7302	MAN	81508046083	EFR7636
MAN	8150804462	EFR7303	MAN	81508046084	EFR7637
MAN	8150804463	EFR7302	MAN	81508046087	EFR5006
MAN	8150804464	EFR7303	MAN	81508046088	EFR5007
MAN	8150804469	EFR6300	MAN	81508046089	EFR5006
MAN	8150804470	EFR6301	MAN	81508046090	EFR5007

Les correspondances de références ont pour seul objectif d'aider la recherche de référence

Cross references are there for the sole purpose of helping the reference search

CORRESPONDANCES DES REFERENCES CROSS REFERENCE LIST

MARQUE/MAKER	REF/PN OES	REF/PN	MARQUE/MAKER	REF/PN OES	REF/PN
MAN	81508046091	EFR6300	MAN	81508046167	EFR7696
MAN	81508046092	EFR6301	MAN	81508046168	EFR7697
MAN	81508046093	EFR6300	MAN	81508046179	EFR7636
MAN	81508046094	EFR6301	MAN	81508046180	EFR7637
MAN	81508046097	EFR7646	MAN	81508046181	EFR7636
MAN	81508046098	EFR7647	MAN	81508046182	EFR7637
MAN	81508046099	EFR7632	MAN	81508046187	EFR7642
MAN	81508046100	EFR7633	MAN	81508046188	EFR7643
MAN	81508046101	EFR7646	MAN	81508046189	EFR7642
MAN	81508046102	EFR7647	MAN	81508046190	EFR7643
MAN	81508046103	EFR7636	MAN	81508046191	EFR7634
MAN	81508046104	EFR7637	MAN	81508046192	EFR7641
MAN	81508046107	EFR7632	MAN	81508046193	EFR7640
MAN	81508046108	EFR7633	MAN	81508046194	EFR7641
MAN	81508046110	EFR7649	MAN	81508046195	EFR7640
MAN	81508046111	EFR7648	MAN	81508046196	EFR7641
MAN	81508046116	EFR7647	MAN	81508046197	EFR7646
MAN	81508046117	EFR7646	MAN	81508046198	EFR7647
MAN	81508046119	EFR7640	MAN	81508046199	EFR7632
MAN	81508046120	EFR7641	MAN	81508046200	EFR7633
MAN	81508046122	EFR7639	MAN	81508046201	EFR7632
MAN	81508046123	EFR7638	MAN	81508046202	EFR7633
MAN	81508046125	EFR7632	MAN	81508046206	EFR7645
MAN	81508046126	EFR7633	MAN	81508046207	EFR7644
MAN	81508046128	EFR7643	MAN	81508046216	EFR7647
MAN	81508046129	EFR7642	MAN	81508046217	EFR7646
MAN	81508046131	EFR7646	MAN	81508046218	EFR7695
MAN	81508046132	EFR7647	MAN	81508046219	EFR7694
MAN	81508046133	EFR7642	MAN	81508046220	EFR7717
MAN	81508046134	EFR7643	MAN	81508046221	EFR7716
MAN	81508046137	EFR7694	MAN	81508046222	EFR7717
MAN	81508046138	EFR7695	MAN	81508046223	EFR7716
MAN	81508046149	EFR7600	MAN	81508046238	EFR7717
MAN	81508046150	EFR7601	MAN	81508046239	EFR7716
MAN	81508046151	EFR7600	MAN	81508046251	EFR7640
MAN	81508046152	EFR7601	MAN	81508046252	EFR7641
MAN	81508046153	EFR7600	MAN	81508046253	EFR7642
MAN	81508046154	EFR7601	MAN	81508046254	EFR7643
MAN	81508046156	EFR6301	MAN	81508046256	EFR7645
MAN	81508046157	EFR6300	MAN	81508046257	EFR7644
MAN	81508046158	EFR7637	MAN	81508046258	EFR7637
MAN	81508046159	EFR7636	MAN	81508046259	EFR7636
MAN	81508046161	EFR7694	MAN	81508046260	EFR7637
MAN	81508046162	EFR7695	MAN	81508046261	EFR7636
MAN	81508046163	EFR7636	MAN	81508046262	EFR7645
MAN	81508046164	EFR7637	MAN	81508046263	EFR7644
MAN	81508046165	EFR7632	MAN	81508046265	EFR7632
MAN	81508046166	EFR7633	MAN	81508046266	EFR7633

Les correspondances de références ont pour seul objectif d'aider la recherche de référence

Cross references are there for the sole purpose of helping the reference search

CORRESPONDANCES DES REFERENCES CROSS REFERENCE LIST

MARQUE/MAKER	REF/PN OES	REF/PN	MARQUE/MAKER	REF/PN OES	REF/PN
MAN	81508046270	EFR7649	MAN	81508046352	EFR7643
MAN	81508046271	EFR7648	MAN	81508046353	EFR7642
MAN	81508046280	EFR7637	MAN	81508046354	EFR5007
MAN	81508046281	EFR7636	MAN	81508046355	EFR5006
MAN	81508046282	EFR7632	MAN	81508046365	EFR6300
MAN	81508046283	EFR7633	MAN	81508046366	EFR6301
MAN	81508046284	EFR7649	MAN	81508046375	EFR7344
MAN	81508046285	EFR7648	MAN	81508046376	EFR7345
MAN	81508046286	EFR7326	MAN	81508046379	EFR7640
MAN	81508046287	EFR7327	MAN	81508046380	EFR7641
MAN	81508046290	EFR7635	MAN	81508046381	EFR7646
MAN	81508046291	EFR7634	MAN	81508046382	EFR7647
MAN	81508046296	EFR7641	MAN	81508046383	EFR7636
MAN	81508046297	EFR7640	MAN	81508046384	EFR7637
MAN	81508046298	EFR7643	MAN	81508046385	EFR7644
MAN	81508046299	EFR7642	MAN	81508046386	EFR7645
MAN	81508046300	EFR7637	MAN	81508046389	EFR7702
MAN	81508046301	EFR7636	MAN	81508046390	EFR7703
MAN	81508046302	EFR7645	MAN	81508046391	EFR7700
MAN	81508046303	EFR7644	MAN	81508046392	EFR7701
MAN	81508046305	EFR7632	MAN	81508046405	EFR7698
MAN	81508046306	EFR7633	MAN	81508046406	EFR7699
MAN	81508046307	EFR7648	MAN	81508046409	EFR7326
MAN	81508046308	EFR7649	MAN	81508046410	EFR7327
MAN	81508046309	EFR7600	MAN	81508046411	EFR7326
MAN	81508046310	EFR7601	MAN	81508046412	EFR7327
MAN	81508046311	EFR7694	MAN	81508046413	EFR7344
MAN	81508046312	EFR7695	MAN	81508046414	EFR7345
MAN	81508046313	EFR7716	MAN	81508046418	EFR5300
MAN	81508046314	EFR7717	MAN	81508046419	EFR5301
MAN	81508046319	EFR7694	MAN	81508046420	EFR5300
MAN	81508046320	EFR7695	MAN	81508046421	EFR5301
MAN	81508046321	EFR7716	MAN	81508046422	EFR7701
MAN	81508046322	EFR7717	MAN	81508046423	EFR7700
MAN	81508046327	EFR5301	MAN	81508046424	EFR7703
MAN	81508046328	EFR5300	MAN	81508046425	EFR7702
MAN	81508046329	EFR5300	MAN	81508046426	EFR7699
MAN	81508046330	EFR5301	MAN	81508046427	EFR7698
MAN	81508046331	EFR7694	MAN	81508046428	EFR7699
MAN	81508046332	EFR7695	MAN	81508046429	EFR7698
MAN	81508046333	EFR5300	MAN	81508046430	EFR7641
MAN	81508046334	EFR5301	MAN	81508046431	EFR7640
MAN	81508046346	EFR7641	MAN	81508046432	EFR7643
MAN	81508046347	EFR7640	MAN	81508046433	EFR7642
MAN	81508046348	EFR7643	MAN	81508046434	EFR7303
MAN	81508046349	EFR7642	MAN	81508046435	EFR7302
MAN	81508046350	EFR7641	MAN	81508046436	EFR7345
MAN	81508046351	EFR7640	MAN	81508046437	EFR7344

Les correspondances de références ont pour seul objectif d'aider la recherche de référence

Cross references are there for the sole purpose of helping the reference search

CORRESPONDANCES DES REFERENCES CROSS REFERENCE LIST

MARQUE/MAKER	REF/PN OES	REF/PN	MARQUE/MAKER	REF/PN OES	REF/PN
MAN	81508046438	EFR7327	MAN	81508046495	EFR7340
MAN	81508046439	EFR7326	MAN	81508046496	EFR7341
MAN	81508046440	EFR7345	MAN	81508046497	EFR7344
MAN	81508046441	EFR7344	MAN	81508046498	EFR7345
MAN	81508046447	EFR6300	MAN	81508046499	EFR7344
MAN	81508046448	EFR6301	MAN	81508046500	EFR7345
MAN	81508046449	EFR7336	MAN	81508046501	EFR7344
MAN	81508046450	EFR7337	MAN	81508046502	EFR7345
MAN	81508046451	EFR7336	MAN	81508046503	EFR7302
MAN	81508046452	EFR7337	MAN	81508046504	EFR7303
MAN	81508046453	EFR7302	MAN	81508046505	EFR7302
MAN	81508046454	EFR7303	MAN	81508046506	EFR7303
MAN	81508046455	EFR7344	MAN	81508046507	EFR7344
MAN	81508046456	EFR7345	MAN	81508046508	EFR7345
MAN	81508046457	EFR7702	MAN	81508046509	EFR7326
MAN	81508046458	EFR7703	MAN	81508046510	EFR7327
MAN	81508046459	EFR7302	MAN	81508046511	EFR7326
MAN	81508046460	EFR7303	MAN	81508046512	EFR7327
MAN	81508046461	EFR7302	MAN	81508046513	EFR7326
MAN	81508046462	EFR7303	MAN	81508046514	EFR7327
MAN	81508046463	EFR7302	MAN	81508046515	EFR7336
MAN	81508046464	EFR7303	MAN	81508046516	EFR7337
MAN	81508046469	EFR6314	MAN	81508046517	EFR7336
MAN	81508046470	EFR6315	MAN	81508046518	EFR7337
MAN	81508046471	EFR6314	MAN	81508046519	EFR7302
MAN	81508046472	EFR6315	MAN	81508046520	EFR7303
MAN	81508046473	EFR7344	MAN	81508046521	EFR7302
MAN	81508046474	EFR7345	MAN	81508046522	EFR7303
MAN	81508046475	EFR6314	MAN	81508046525	EFR7345
MAN	81508046476	EFR6315	MAN	81508046526	EFR7344
MAN	81508046477	EFR6300	MAN	81508046536	EFR5305
MAN	81508046478	EFR6301	MAN	81508046537	EFR5304
MAN	81508046479	EFR6300	MAN	81508046538	EFR5305
MAN	81508046480	EFR6301	MAN	81508046539	EFR5304
MAN	81508046481	EFR5304	MAN	81508046540	EFR5305
MAN	81508046482	EFR5305	MAN	81508046541	EFR5304
MAN	81508046483	EFR5304	MAN	81508046542	EFR5305
MAN	81508046484	EFR5305	MAN	81508046543	EFR5304
MAN	81508046485	EFR5304	MAN	81508046544	EFR5301
MAN	81508046486	EFR5305	MAN	81508046545	EFR5300
MAN	81508046487	EFR5300	MAN	81508046546	EFR6315
MAN	81508046488	EFR5301	MAN	81508046547	EFR6314
MAN	81508046489	EFR7314	MAN	81508046552	EFR7005
MAN	81508046490	EFR7315	MAN	81508046553	EFR7004
MAN	81508046491	EFR7314	MAN	81508046556	EFR7005
MAN	81508046492	EFR7315	MAN	81508046557	EFR7004
MAN	81508046493	EFR7340	MAN	81508046562	EFR7007
MAN	81508046494	EFR7341	MAN	81508046563	EFR7006

Les correspondances de références ont pour seul objectif d'aider la recherche de référence

Cross references are there for the sole purpose of helping the reference search

CORRESPONDANCES DES REFERENCES CROSS REFERENCE LIST

MARQUE/MAKER	REF/PN OES	REF/PN	MARQUE/MAKER	REF/PN OES	REF/PN
MAN	81508046576	EFR7005	MAN	81508046633	EFR7006
MAN	81508046577	EFR7004	MAN	81508046634	EFR7007
MAN	81508046578	EFR7005	MAN	81508046635	EFR7004
MAN	81508046579	EFR7004	MAN	81508046636	EFR7005
MAN	81508046580	EFR7007	MAN	81508046637	EFR7006
MAN	81508046581	EFR7006	MAN	81508046638	EFR7007
MAN	81508046582	EFR7007	MAN	81508046645	EFR7004
MAN	81508046583	EFR7006	MAN	81508046646	EFR7005
MAN	81508046584	EFR6315	MAN	81508046647	EFR7006
MAN	81508046585	EFR6314	MAN	81508046648	EFR7007
MAN	81508046586	EFR6315	MAN	81508046649	EFR7311
MAN	81508046587	EFR6314	MAN	81508046650	EFR7310
MAN	81508046588	EFR6315	MAN	81508046651	EFR7311
MAN	81508046589	EFR6314	MAN	81508046652	EFR7310
MAN	81508046591	EFR6300	MAN	81508046653	EFR7326
MAN	81508046592	EFR6301	MAN	81508046654	EFR7327
MAN	81508046593	EFR6300	MAN	81508046655	EFR7326
MAN	81508046594	EFR6301	MAN	81508046656	EFR7327
MAN	81508046595	EFR7310	MAN	81508046657	EFR7340
MAN	81508046596	EFR7311	MAN	81508046658	EFR7341
MAN	81508046597	EFR7344	MAN	81508046661	EFR7310
MAN	81508046598	EFR7345	MAN	81508046662	EFR7311
MAN	81508046599	EFR7310	MAN	81508046669	EFR7310
MAN	81508046600	EFR7311	MAN	81508046670	EFR7311
MAN	81508046601	EFR7302	MAN	81508046677	EFR7310
MAN	81508046602	EFR7303	MAN	81508046678	EFR7311
MAN	81508046603	EFR7302	MAN	81508046681	EFR6300
MAN	81508046604	EFR7303	MAN	81508046682	EFR6301
MAN	81508046605	EFR7310	MAN	81508046683	EFR7336
MAN	81508046606	EFR7311	MAN	81508046684	EFR7337
MAN	81508046607	EFR7330	MAN	81508046685	EFR7311
MAN	81508046608	EFR7331	MAN	81508046686	EFR7310
MAN	81508046609	EFR7330	MAN	81508046687	EFR7303
MAN	81508046610	EFR7331	MAN	81508046688	EFR7302
MAN	81508046611	EFR7326	MAN	81508046689	EFR7310
MAN	81508046612	EFR7327	MAN	81508046690	EFR7311
MAN	81508046613	EFR7336	MAN	81508046693	EFR5304
MAN	81508046614	EFR7337	MAN	81508046694	EFR5305
MAN	81508046615	EFR7336	MAN	81508046695	EFR5304
MAN	81508046616	EFR7337	MAN	81508046696	EFR5305
MAN	81508046617	EFR7302	MAN	81508046697	EFR6314
MAN	81508046618	EFR7303	MAN	81508046698	EFR6315
MAN	81508046619	EFR7302	MAN	81508046699	EFR6300
MAN	81508046620	EFR7303	MAN	81508046700	EFR6301
MAN	81508046621	EFR7310	MAN	81508046701	EFR6314
MAN	81508046622	EFR7311	MAN	81508046702	EFR6315
MAN	81508046631	EFR7005	MAN	81508046703	EFR6315
MAN	81508046632	EFR7004	MAN	81508046704	EFR6314

Les correspondances de références ont pour seul objectif d'aider la recherche de référence

Cross references are there for the sole purpose of helping the reference search

CORRESPONDANCES DES REFERENCES CROSS REFERENCE LIST

MARQUE/MAKER	REF/PN OES	REF/PN	MARQUE/MAKER	REF/PN OES	REF/PN
MAN	81508046705	EFR6314	MAN	81508205025	2928502
MAN	81508046706	EFR6315	MAN	81508205025	CVP032K
MAN	81508046707	EFR6315	MAN	81508205029	2928502
MAN	81508046708	EFR6314	MAN	81508205029	CVP032K
MAN	81508046709	EFR6300	MAN	81508205040	2903005392
MAN	81508046710	EFR6301	MAN	81508205040	2911303
MAN	81508046711	EFR6301	MAN	81508205041	2905301
MAN	81508046712	EFR6300	MAN	81508205047	2911303
MAN	81508046713	EFR6300	MAN	81508205048	2905301
MAN	81508046714	EFR6301	MAN	81508205060	2911303
MAN	81508046715	EFR6301	MAN	81508205061	2905301
MAN	81508046716	EFR6300	MAN	81508205064	2903005392
MAN	81508046719	EFR7310	MAN	81508205064	2911307
MAN	81508046720	EFR7311	MAN	81508205065	2905301
MAN	81508046721	EFR7311	MAN	81508205066	2911303
MAN	81508046722	EFR7310	MAN	81508205068	2911303
MAN	81508046723	EFR7326	MAN	81508205069	2905301
MAN	81508046724	EFR7327	MAN	81508205072	2913103
MAN	81508046725	EFR7336	MAN	81508205072	CVP088K
MAN	81508046726	EFR7337	MAN	81508205073	2913103
MAN	81508046727	EFR7303	MAN	81508205073	CVP088K
MAN	81508046728	EFR7302	MAN	81508205080	2913103
MAN	81508049002	EFR6301	MAN	81508205080	CVP088K
MAN	81508049003	EFR6300	MAN	81508205085	2918302
MAN	81508049017	EFR5008	MAN	81508205087	2903005392
MAN	81508049018	EFR5009	MAN	81508205088	2903005392
MAN	81508049070	EFR5007	MAN	81508205088	2905301
MAN	81508049071	EFR5006	MAN	81508205091	2903005392
MAN	81508049087	EFR5006	MAN	81508205091	2903007
MAN	81508049088	EFR5007	MAN	81508205091	2903024
MAN	81508049265	EFR7632	MAN	81508205091	2911303
MAN	81508049266	EFR7633	MAN	81508205091	CVP013K
MAN	81508049651	EFR7311	MAN	81508205092	2903005392
MAN	81508049652	EFR7310	MAN	81508205092	2905301
MAN	81508049655	EFR7326	MAN	81508205094	2932005
MAN	81508049656	EFR7327	MAN	81508205094	CVP036K
MAN	81508100005	CAC001	MAN	81508205098	2932001
MAN	81508110004	98017600	MAN	81508205098	2932003
MAN	81508205006	2903005392	MAN	81508205098	CVP036K
MAN	81508205006	2911303	MAN	81508205099	2920200604
MAN	81508205007	2905301	MAN	81508205099	2927801
MAN	81508205017	2932001	MAN	81508205099	2927802
MAN	81508205017	2932003	MAN	81508205099	CVP020K
MAN	81508205017	CVP036K	MAN	81508205108	2927900604
MAN	81508205020	2911303	MAN	81508205108	2927901
MAN	81508205021	2905301	MAN	81508205112	2927900604
MAN	81508205023	2928502	MAN	81508205112	2927901
MAN	81508205023	CVP032K	MAN	81508205116	2927801

Les correspondances de références ont pour seul objectif d'aider la recherche de référence

Cross references are there for the sole purpose of helping the reference search

CORRESPONDANCES DES REFERENCES CROSS REFERENCE LIST

MARQUE/MAKER	REF/PN OES	REF/PN	MARQUE/MAKER	REF/PN OES	REF/PN
MAN	81508206000	2911303	MAN	81508206041	2913103
MAN	81508206001	2905301	MAN	81508206041	CVP088K
MAN	81508206002	2911303	MAN	81508206042	2928502
MAN	81508206003	2905301	MAN	81508206042	CVP032K
MAN	81508206004	2911303	MAN	81508206043	2918302
MAN	81508206005	2905301	MAN	81508206044	2903005392
MAN	81508206006	2928502	MAN	81508206044	2911303
MAN	81508206006	CVP032K	MAN	81508206045	2903005392
MAN	81508206008	2932001	MAN	81508206045	2905301
MAN	81508206008	2932003	MAN	81508206046	2903005392
MAN	81508206008	CVP036K	MAN	81508206046	2911303
MAN	81508206009	2905503	MAN	81508206047	2903005392
MAN	81508206014	2911303	MAN	81508206051	2913103
MAN	81508206015	2905301	MAN	81508206051	CVP088K
MAN	81508206016	2903005392	MAN	81508206052	2913103
MAN	81508206016	2911303	MAN	81508206052	CVP088K
MAN	81508206017	2905301	MAN	81508206054	2918302
MAN	81508206020	2928502	MAN	81508206055	2920200604
MAN	81508206020	CVP032K	MAN	81508206055	2925305390
MAN	81508206022	2932001	MAN	81508206055	2927801
MAN	81508206022	2932003	MAN	81508206055	CVP020K
MAN	81508206022	CVP036K	MAN	81508206056	2920200604
MAN	81508206024	2911303	MAN	81508206056	2925305390
MAN	81508206025	2903005392	MAN	81508206056	2927801
MAN	81508206025	2911303	MAN	81508206056	CVP020K
MAN	81508206026	2903005392	MAN	81508206058	2932001
MAN	81508206026	2905301	MAN	81508206058	2932003
MAN	81508206030	2920200604	MAN	81508206058	2932005
MAN	81508206030	2925305390	MAN	81508206058	CVP036K
MAN	81508206030	2927801	MAN	81508206059	2932001
MAN	81508206030	CVP020K	MAN	81508206059	2932003
MAN	81508206031	2913103	MAN	81508206059	CVP036K
MAN	81508206031	CVP088K	MAN	81508206060	2932001
MAN	81508206032	2920200604	MAN	81508206060	2932003
MAN	81508206032	2925305390	MAN	81508206060	CVP036K
MAN	81508206032	2927801	MAN	81508206061	2920200604
MAN	81508206032	CVP020K	MAN	81508206061	2925305390
MAN	81508206033	2920200604	MAN	81508206061	2927801
MAN	81508206033	2925305390	MAN	81508206061	2927802
MAN	81508206033	2927801	MAN	81508206061	CVP020K
MAN	81508206033	CVP020K	MAN	81508206063	2918302
MAN	81508206034	2903005392	MAN	81508206064	2932001
MAN	81508206034	2911303	MAN	81508206064	2932003
MAN	81508206035	2905301	MAN	81508206064	CVP036K
MAN	81508206036	2903005392	MAN	81508206065	2927900604
MAN	81508206036	2911307	MAN	81508206065	2927901
MAN	81508206038	2903005392	MAN	81508206066	2927900604
MAN	81508206038	2911303	MAN	81508206066	2927901

Les correspondances de références ont pour seul objectif d'aider la recherche de référence

Cross references are there for the sole purpose of helping the reference search

CORRESPONDANCES DES REFERENCES CROSS REFERENCE LIST

MARQUE/MAKER	REF/PN OES	REF/PN	MARQUE/MAKER	REF/PN OES	REF/PN
MAN	81508206070	2920200604	MAN	81508226036	CAC042
MAN	81508206070	2927802	MAN	81508226037	CAC007
MAN	81508206070	CVP020K	MAN	81508226043	CAC024
MAN	81508206071	2920200604	MAN	81508226043	CAC042
MAN	81508206071	2925305390	MAN	81508226044	2911303
MAN	81508206071	2927801	MAN	8158206052	2913105
MAN	81508206071	2927802	MAN	8158206052	CVP088K
MAN	81508206071	CVP020K	MAN	82508030041	09.9467.10
MAN	81508206072	2920200604	MAN	82508030041	93087000
MAN	81508206072	2925305390	MAN	82508030041	DF70002
MAN	81508206072	2927802	MAN	82508030041	FCR215A
MAN	81508206081	2920200604	MAN	N1011015716	2905503
MAN	81508206083	2920200604	MAN	N1014011215	EFR7315
MAN	81508206083	2927801	MAN	N1014011853	EFR7314
MAN	81508206083	CVP020K	MAN	N1014011854	EFR7316
MAN	81508206087	2918302	MAN	N1014011855	EFR7317
MAN	81508206090	2927900604	MAN	N2508049106	EFR7696
MAN	81508206090	2927901	MAN	N2508049107	EFR7697
MAN	81508206091	2920200604	MAN	N2508049108	EFR7630
MAN	81508206093	2920200604	MAN	N2508049109	EFR6602
MAN	8150820646	2903007	MAN	N2508049110	EFR6603
MAN	8150820646	2903024	MAN	ZG070160007	CAC015
MAN	8150820646	CVP013K	MENARINI	254625	2915001
MAN	81508207072	2925305390	MERCEDES	0004200272	93101200
MAN	81508207072	2927801	MERCEDES	0004200312	93101200
MAN	81508207072	CVP020K	MERCEDES	0004202982	CAC042
MAN	81508220014	CAC040	MERCEDES	0004210312	93101200
MAN	81508226007	CAC008	MERCEDES	0004210510	2920200604
MAN	81508226009	CAC005	MERCEDES	0004210510	2925305390
MAN	81508226011	98024300	MERCEDES	0004210510	2927801
MAN	81508226012	W0400MA1	MERCEDES	0004210510	2927802
MAN	81508226014	98024400	MERCEDES	0004210510	CVP020K
MAN	81508226014	W0295MA1	MERCEDES	0004210710	2932003
MAN	81508226015	98032000	MERCEDES	0004210710	2932004
MAN	81508226015	W0400MA	MERCEDES	0004210710	2936101
MAN	81508226016	98024300	MERCEDES	0004210710	CVP036K
MAN	81508226017	98024300	MERCEDES	0004210810	2932003
MAN	81508226017	W0400MA1	MERCEDES	0004210810	2936101
MAN	81508226019	CAC007	MERCEDES	0004210810	CVP036K
MAN	81508226019	CAC042	MERCEDES	0004211010	2918302
MAN	81508226020	CAC009	MERCEDES	0004211210	2918302
MAN	81508226022	CAC008	MERCEDES	0004211810	2920200604
MAN	81508226023	CAC024	MERCEDES	0004211810	2927801
MAN	81508226023	CAC042	MERCEDES	0004211810	2927802
MAN	81508226031	CAC009	MERCEDES	0004211810	CVP020K
MAN	81508226032	CAC008	MERCEDES	0004213712	09.A741.10
MAN	81508226034	CAC025	MERCEDES	0004213712	93186700
MAN	81508226036	CAC024	MERCEDES	0004213712	DF70008

Les correspondances de références ont pour seul objectif d'aider la recherche de référence

Cross references are there for the sole purpose of helping the reference search

CORRESPONDANCES DES REFERENCES CROSS REFERENCE LIST

MARQUE/MAKER	REF/PN OES	REF/PN	MARQUE/MAKER	REF/PN OES	REF/PN
MERCEDES	0004213712	FCR323A	MERCEDES	0014207001	EFR7305
MERCEDES	0004214310	2920200604	MERCEDES	0014210510	2918302
MERCEDES	0004214310	2925305390	MERCEDES	0014210610	2918302
MERCEDES	0004214310	2927801	MERCEDES	0014211710	2932002
MERCEDES	0004214310	2927802	MERCEDES	0014211710	2932003
MERCEDES	0004214310	CVP020K	MERCEDES	0014211710	2932004
MERCEDES	0004215010	2932003	MERCEDES	0014211710	2936101
MERCEDES	0004215010	2936101	MERCEDES	0014211710	CVP036K
MERCEDES	0004215010	CVP036K	MERCEDES	0014212510	2918302
MERCEDES	0004230316	CAC043	MERCEDES	0014212610	2918302
MERCEDES	0004232412	09.B325.30	MERCEDES	0014213610	2920200604
MERCEDES	0004232412	93087900	MERCEDES	0014213610	2927802
MERCEDES	0004232412	DF70000	MERCEDES	0014213610	CVP020K
MERCEDES	0004232412	FCR145A	MERCEDES	0014215210	2931501
MERCEDES	0004232774	CAC042	MERCEDES	0014215210	29315FLE1749
MERCEDES	0004236610	2920200604	MERCEDES	0024200820	2908302
MERCEDES	0004236610	2927801	MERCEDES	0024200820	CVP013K
MERCEDES	0004236610	2927802	MERCEDES	0024201401	EFR5300
MERCEDES	0004236610	CVP020K	MERCEDES	0024201483	EFR7304
MERCEDES	0014200501	EFR7300	MERCEDES	002420148310	EFR7304
MERCEDES	0014200601	EFR7301	MERCEDES	002420148380	EFR7304
MERCEDES	0014200701	EFR7300	MERCEDES	0024201501	EFR5301
MERCEDES	0014200801	EFR7301	MERCEDES	0024201583	EFR7305
MERCEDES	0014201001	EFR7300	MERCEDES	002420158310	EFR7305
MERCEDES	0014201101	EFR7301	MERCEDES	002420158380	EFR7305
MERCEDES	0014201401	EFR6307	MERCEDES	0024201601	EFR5302
MERCEDES	0014201501	EFR6306	MERCEDES	0024201701	EFR5303
MERCEDES	0014202101	EFR5300	MERCEDES	0024201801	EFR6306
MERCEDES	0014202201	EFR5301	MERCEDES	0024201901	EFR6307
MERCEDES	0014202301	EFR7304	MERCEDES	0024202001	EFR6305
MERCEDES	0014202401	EFR7305	MERCEDES	0024202101	EFR6304
MERCEDES	0014202501	EFR7304	MERCEDES	0024202201	EFR6307
MERCEDES	0014202601	EFR7305	MERCEDES	002420222010	2920200604
MERCEDES	0014204401	EFR7316	MERCEDES	002420222010	2925305390
MERCEDES	0014204501	EFR7317	MERCEDES	002420222010	2927801
MERCEDES	0014205001	EFR7316	MERCEDES	002420222010	2927802
MERCEDES	0014205101	EFR7317	MERCEDES	002420222010	CVP020K
MERCEDES	0014205201	EFR7304	MERCEDES	0024202301	EFR6306
MERCEDES	0014205301	EFR7305	MERCEDES	0024202401	EFR6304
MERCEDES	0014205701	EFR6304	MERCEDES	0024202501	EFR6305
MERCEDES	0014205801	EFR6305	MERCEDES	0024202601	EFR6300
MERCEDES	0014205901	EFR6304	MERCEDES	0024202701	EFR6301
MERCEDES	0014206001	EFR6305	MERCEDES	0024203001	EFR6307
MERCEDES	0014206101	EFR6300	MERCEDES	0024203101	EFR6306
MERCEDES	0014206201	EFR6301	MERCEDES	0024203201	EFR6304
MERCEDES	0014206301	EFR5302	MERCEDES	0024203301	EFR6305
MERCEDES	0014206401	EFR5303	MERCEDES	0024203401	EFR6306
MERCEDES	0014206901	EFR7304	MERCEDES	0024203501	EFR6307

Les correspondances de références ont pour seul objectif d'aider la recherche de référence

Cross references are there for the sole purpose of helping the reference search

CORRESPONDANCES DES REFERENCES CROSS REFERENCE LIST

MARQUE/MAKER	REF/PN OES	REF/PN	MARQUE/MAKER	REF/PN OES	REF/PN
MERCEDES	0024203601	EFR6305	MERCEDES	0034201620	2927801
MERCEDES	0024203683	EFR6300	MERCEDES	0034201620	2927802
MERCEDES	0024203701	EFR6304	MERCEDES	0034201620	CVP020K
MERCEDES	0024203783	EFR6301	MERCEDES	0034201620000	2927802
MERCEDES	0024203883	EFR7304	MERCEDES	0034202020	2920200604
MERCEDES	0024203983	EFR7305	MERCEDES	0034202020	2925305390
MERCEDES	0024204101	EFR6307	MERCEDES	0034202020	2927801
MERCEDES	0024204201	EFR6306	MERCEDES	0034202020	2927802
MERCEDES	0024204301	EFR6304	MERCEDES	0034202020	CVP020K
MERCEDES	0024204401	EFR6305	MERCEDES	0034202220	2925305390
MERCEDES	0024204920	2920200604	MERCEDES	0034202220	2927801
MERCEDES	0024204920	2925305390	MERCEDES	0034203520	2920200604
MERCEDES	0024204920	2927801	MERCEDES	0034203520	2925305390
MERCEDES	0024204920	2927802	MERCEDES	0034203520	2927801
MERCEDES	0024204920	CVP020K	MERCEDES	0034203520	2927802
MERCEDES	0024204970	2927801	MERCEDES	0034203520	CVP020K
MERCEDES	0024204983	EFR7300	MERCEDES	0034206620	2918302
MERCEDES	0024205083	EFR7301	MERCEDES	0034207220	2918302
MERCEDES	0024205183	EFR7316	MERCEDES	0034207320	2918302
MERCEDES	0024205283	EFR7317	MERCEDES	0034208420	2903009
MERCEDES	0024205520	2908302	MERCEDES	0034208420	CVP013K
MERCEDES	0024205520	CVP013K	MERCEDES	0034209183	EFR6308
MERCEDES	0024207020	2920200604	MERCEDES	0034209283	EFR6309
MERCEDES	0024207020	2927801	MERCEDES	0044201320	2932002
MERCEDES	0024207020	2927802	MERCEDES	0044201320	2932003
MERCEDES	0024207020	CVP020K	MERCEDES	0044201320	CVP036K
MERCEDES	0024207820	2932003	MERCEDES	0044202220	2920200604
MERCEDES	0024207820	2932004	MERCEDES	0044202220	2925305390
MERCEDES	0024207820	2936101	MERCEDES	0044202220	2927801
MERCEDES	0024207820	CVP036K	MERCEDES	0044202220	2927802
MERCEDES	0024207828	2936101	MERCEDES	0044202220	CVP020K
MERCEDES	0024207828	CVP036K	MERCEDES	0044202583	EFR7300
MERCEDES	0024207920	2932003	MERCEDES	004420258380	EFR7301
MERCEDES	0024207920	2932004	MERCEDES	0044202683	EFR7301
MERCEDES	0024207920	2936101	MERCEDES	004420268380	EFR7300
MERCEDES	0024207920	CVP036K	MERCEDES	0044206020	2920200604
MERCEDES	0024208583	EFR7310	MERCEDES	0044206020	2925305390
MERCEDES	0024208683	EFR7311	MERCEDES	0044206020	2927801
MERCEDES	0024209283	EFR7310	MERCEDES	0044206020	2927802
MERCEDES	0024209983	EFR7311	MERCEDES	0044206020	CVP020K
MERCEDES	0034201020	2920200604	MERCEDES	0044206120	2918302
MERCEDES	0034201020	2927801	MERCEDES	0044207020	2925705390
MERCEDES	0034201020	2927802	MERCEDES	0044207020	2926900604
MERCEDES	0034201020	CVP020K	MERCEDES	0044207020	2926901
MERCEDES	0034201120	2918302	MERCEDES	0044207020	FCV4461PTS
MERCEDES	0034201220	2918302	MERCEDES	0044207383	EFR7348
MERCEDES	0034201620	2920200604	MERCEDES	00442073830080	EFR7348
MERCEDES	0034201620	2925305390	MERCEDES	0044207483	EFR7349

Les correspondances de références ont pour seul objectif d'aider la recherche de référence

Cross references are there for the sole purpose of helping the reference search

CORRESPONDANCES DES REFERENCES CROSS REFERENCE LIST

MARQUE/MAKER	REF/PN OES	REF/PN	MARQUE/MAKER	REF/PN OES	REF/PN
MERCEDES	00442074830080	EFR7349	MERCEDES	0084206020	2920200604
MERCEDES	004420750080	EFR7346	MERCEDES	0084206020	2925305390
MERCEDES	0044207583	EFR7346	MERCEDES	0084206020	2927801
MERCEDES	004420760080	EFR7347	MERCEDES	0084206020	2927802
MERCEDES	0044207683	EFR7347	MERCEDES	0084206020	CVP020K
MERCEDES	004420770080	EFR7350	MERCEDES	0084206320	2931501
MERCEDES	0044207783	EFR7350	MERCEDES	0084206320	29315FLE1749
MERCEDES	004420780080	EFR7351	MERCEDES	0084206420	2931501
MERCEDES	0044207883	EFR7351	MERCEDES	0084206420	29315FLE1749
MERCEDES	0044207983	EFR7345	MERCEDES	0084206520	2918302
MERCEDES	0044207983	EFR7353	MERCEDES	0084206620	2918302
MERCEDES	00442079830080	EFR7353	MERCEDES	0084207320	2924401
MERCEDES	0044208083	EFR7352	MERCEDES	0084207320	FCV4418PTS
MERCEDES	00442080830080	EFR7352	MERCEDES	0104216298	EFR7316
MERCEDES	0044209383	EFR7304	MERCEDES	0104216398	EFR7317
MERCEDES	0044209483	EFR7305	MERCEDES	0104218898	EFR7316
MERCEDES	0044214310	2920200604	MERCEDES	0104218998	EFR7317
MERCEDES	0044214310	2927802	MERCEDES	2420222010	2920200604
MERCEDES	0044214310	CVP020K	MERCEDES	3564202501	EFR7604
MERCEDES	0054200583	EFR7352	MERCEDES	3564202601	EFR7605
MERCEDES	0054201783	EFR6305	MERCEDES	3564202801	EFR7608
MERCEDES	0054201883	EFR6304	MERCEDES	3564202901	EFR7609
MERCEDES	0054202320	2932003	MERCEDES	3564210312	09.8129.10
MERCEDES	0054202320	2932004	MERCEDES	3564210312	93058200
MERCEDES	0054202320	2936101	MERCEDES	3564210312	FCR120A
MERCEDES	0054202320	CVP036K	MERCEDES	3564211012	09.8129.10
MERCEDES	0064201020	2920200604	MERCEDES	3564211012	93058200
MERCEDES	0064201020	2927801	MERCEDES	3564211012	FCR120A
MERCEDES	0064201020	2927802	MERCEDES	3564211212	09.8129.10
MERCEDES	0064201020	CVP020K	MERCEDES	3564211212	93058200
MERCEDES	0064201120	2920200604	MERCEDES	3564211212	FCR120A
MERCEDES	0064201120	2925305390	MERCEDES	3565400017	98017200
MERCEDES	0064201120	2927801	MERCEDES	4054200020	2913401
MERCEDES	0064201120	CVP020K	MERCEDES	4054200220	2913401
MERCEDES	0064201420	2924601	MERCEDES	4054202020	2913401
MERCEDES	0064201420	FCV4417PTS	MERCEDES	4054210498	EFR6124
MERCEDES	0064201520	2924401	MERCEDES	4054210598	EFR6125
MERCEDES	0064201520	FCV4418PTS	MERCEDES	442073830080	EFR7348
MERCEDES	0064205220	2924601	MERCEDES	442074830080	EFR7349
MERCEDES	0064205220	FCV4417PTS	MERCEDES	4420750080	EFR7346
MERCEDES	0064205320	2924401	MERCEDES	4420760080	EFR7347
MERCEDES	0064205320	FCV4418PTS	MERCEDES	4420770080	EFR7350
MERCEDES	0084205820	2932003	MERCEDES	4420780080	EFR7351
MERCEDES	0084205820	2936101	MERCEDES	6270000042	EFR7606
MERCEDES	0084205820	CVP036K	MERCEDES	6270000142	EFR7607
MERCEDES	0084205920	2932003	MERCEDES	6270000442	EFR7606
MERCEDES	0084205920	2936101	MERCEDES	6270000542	EFR7607
MERCEDES	0084205920	CVP036K	MERCEDES	6270005642	EFR7606

Les correspondances de références ont pour seul objectif d'aider la recherche de référence

Cross references are there for the sole purpose of helping the reference search

CORRESPONDANCES DES REFERENCES CROSS REFERENCE LIST

MARQUE/MAKER	REF/PN OES	REF/PN	MARQUE/MAKER	REF/PN OES	REF/PN
MERCEDES	6270005742	EFR7607	MERCEDES	6664300190	EFR7311
MERCEDES	6274210012	09.8129.20	MERCEDES	6754210012	93276800
MERCEDES	6274210012	93058100	MERCEDES	6754210012	FCR346A
MERCEDES	6274210012	FCR114A	MERCEDES	6754210112	09.8573.10
MERCEDES	6274300090	EFR7303	MERCEDES	6754210112	93101400
MERCEDES	6274300190	EFR7302	MERCEDES	6754210112	FCR189A
MERCEDES	6274300290	EFR7315	MERCEDES	6754230312	09.8925.10
MERCEDES	6274300390	EFR7314	MERCEDES	6754230312	93101500
MERCEDES	6274300490	EFR7315	MERCEDES	6754230312	FCR190A
MERCEDES	6274300590	EFR7314	MERCEDES	6764200924	EFR7304
MERCEDES	6284200101	EFR7304	MERCEDES	6764201024	EFR7305
MERCEDES	6284200201	EFR7305	MERCEDES	6934200120	2927801
MERCEDES	6284200701	EFR7304	MERCEDES	6954230512	09.B325.30
MERCEDES	6284200801	EFR7305	MERCEDES	6954230512	93087900
MERCEDES	6284200901	EFR7304	MERCEDES	6954230512	DF70000
MERCEDES	6284201001	EFR7305	MERCEDES	6954230512	FCR145A
MERCEDES	6284201101	EFR7304	MERCEDES	6964200601	EFR7312
MERCEDES	6284201201	EFR7305	MERCEDES	6964200701	EFR7313
MERCEDES	6294200101	EFR7312	MERCEDES	6964200801	EFR7312
MERCEDES	6294200102	EFR7342	MERCEDES	6964200901	EFR7313
MERCEDES	6294200201	EFR7313	MERCEDES	6964201101	EFR7312
MERCEDES	6294200202	EFR7343	MERCEDES	6964201201	EFR7313
MERCEDES	6294200301	EFR7312	MERCEDES	6964201301	EFR7312
MERCEDES	6294200302	EFR7342	MERCEDES	6964201401	EFR7313
MERCEDES	6294200401	EFR7313	MERCEDES	6964202101	EFR6305
MERCEDES	6294200402	EFR7343	MERCEDES	6964202201	EFR6304
MERCEDES	6294200502	EFR7342	MERCEDES	6964202601	EFR7304
MERCEDES	6294200601	EFR7312	MERCEDES	6964202701	EFR7305
MERCEDES	6294200602	EFR7343	MERCEDES	6964203001	EFR7308
MERCEDES	6294200701	EFR7313	MERCEDES	6964203101	EFR7309
MERCEDES	6294200801	EFR7312	MERCEDES	6964203401	EFR7304
MERCEDES	6294200901	EFR7313	MERCEDES	6964203501	EFR7305
MERCEDES	6294201101	EFR7312	MERCEDES	6964203701	EFR7309
MERCEDES	6294201201	EFR7313	MERCEDES	6964203801	EFR7308
MERCEDES	6294201301	EFR7312	MERCEDES	6964203901	EFR7310
MERCEDES	6294201401	EFR7313	MERCEDES	6964204001	EFR7311
MERCEDES	6294201501	EFR7312	MERCEDES	6964204301	EFR7308
MERCEDES	6294201601	EFR7313	MERCEDES	6964204401	EFR7309
MERCEDES	6294300090	EFR7304	MERCEDES	6964204501	EFR7310
MERCEDES	6294300190	EFR7305	MERCEDES	6964204601	EFR7311
MERCEDES	6294300290	EFR7304	MERCEDES	6964205501	EFR7310
MERCEDES	6294300390	EFR7305	MERCEDES	6964205601	EFR7311
MERCEDES	6294300490	EFR7311	MERCEDES	7404200001	EFR7310
MERCEDES	6294300590	EFR7310	MERCEDES	7404200101	EFR7311
MERCEDES	638421011205	09.8574.10	MERCEDES	7404200201	EFR7308
MERCEDES	638421011205	93101300	MERCEDES	7404200301	EFR7309
MERCEDES	638421011205	FCR186A	MERCEDES	7494201001	EFR7304
MERCEDES	6664300090	EFR7310	MERCEDES	7494201101	EFR7305

Les correspondances de références ont pour seul objectif d'aider la recherche de référence

Cross references are there for the sole purpose of helping the reference search

CORRESPONDANCES DES REFERENCES CROSS REFERENCE LIST

MARQUE/MAKER	REF/PN OES	REF/PN	MARQUE/MAKER	REF/PN OES	REF/PN
MERCEDES	9054200072	93191600	MERCEDES	9424204901	EFR7304
MERCEDES	9054200072	FCR300A	MERCEDES	9424205001	EFR7305
MERCEDES	9244211012	09.B325.30	MERCEDES	9424205101	EFR7300
MERCEDES	9244211012	93087900	MERCEDES	9424205201	EFR7301
MERCEDES	9244211012	DF70000	MERCEDES	9424205601	EFR7304
MERCEDES	9244211012	FCR145A	MERCEDES	9424205701	EFR7305
MERCEDES	9424200401	EFR7304	MERCEDES	9424205801	EFR7304
MERCEDES	9424200501	EFR7305	MERCEDES	9424205901	EFR7305
MERCEDES	9424200601	EFR7304	MERCEDES	9424206001	EFR7304
MERCEDES	9424200701	EFR7305	MERCEDES	9424206101	EFR7305
MERCEDES	9424200801	EFR7304	MERCEDES	9424206201	EFR7304
MERCEDES	9424200901	EFR7305	MERCEDES	9424206301	EFR7305
MERCEDES	9424201001	EFR7304	MERCEDES	9424206501	EFR7300
MERCEDES	9424201101	EFR7305	MERCEDES	9424206601	EFR7301
MERCEDES	9424201201	EFR7304	MERCEDES	9424206701	EFR7300
MERCEDES	9424201301	EFR7305	MERCEDES	9424206801	EFR7301
MERCEDES	9424201401	EFR7304	MERCEDES	9424206901	EFR7300
MERCEDES	9424201501	EFR7305	MERCEDES	9424207001	EFR7301
MERCEDES	9424201601	EFR7304	MERCEDES	9424210912	09.B325.30
MERCEDES	9424201701	EFR7305	MERCEDES	9424210912	93087900
MERCEDES	9424201901	EFR7304	MERCEDES	9424210912	DF70000
MERCEDES	9424202001	EFR7305	MERCEDES	9424210912	FCR145A
MERCEDES	9424202101	EFR7304	MERCEDES	9424211012	09.B325.30
MERCEDES	9424202201	EFR7305	MERCEDES	9424211012	93087900
MERCEDES	9424202301	EFR7304	MERCEDES	9424211012	DF70000
MERCEDES	9424202401	EFR7305	MERCEDES	9424211012	FCR145A
MERCEDES	9424202501	EFR7300	MERCEDES	9424211112	09.B325.30
MERCEDES	9424202601	EFR7301	MERCEDES	9424211112	93087900
MERCEDES	9424202701	EFR7304	MERCEDES	9424211112	DF70000
MERCEDES	9424202801	EFR7305	MERCEDES	9424211112	FCR145A
MERCEDES	9424202901	EFR7300	MERCEDES	9424211212	09.B325.30
MERCEDES	9424203001	EFR7301	MERCEDES	9424211212	93087900
MERCEDES	9424203101	EFR7304	MERCEDES	9424211212	DF70000
MERCEDES	9424203201	EFR7305	MERCEDES	9424211212	FCR145A
MERCEDES	9424203301	EFR7304	MERCEDES	9424211312	09.8793.10
MERCEDES	9424203401	EFR7305	MERCEDES	9424211312	93101800
MERCEDES	9424203701	EFR7304	MERCEDES	9424211312	FCR201A
MERCEDES	9424203801	EFR7305	MERCEDES	9424212112	09.B325.30
MERCEDES	9424203901	EFR7300	MERCEDES	9424212112	93087900
MERCEDES	9424204001	EFR7301	MERCEDES	9424212112	DF70000
MERCEDES	9424204101	EFR7300	MERCEDES	9424212112	FCR145A
MERCEDES	9424204201	EFR7301	MERCEDES	9424212312	09.B325.30
MERCEDES	9424204301	EFR7300	MERCEDES	9424212312	93087900
MERCEDES	9424204401	EFR7301	MERCEDES	9424212312	DF70000
MERCEDES	9424204501	EFR7300	MERCEDES	9424212312	FCR145A
MERCEDES	9424204601	EFR7301	MERCEDES	9424212512	09.B325.30
MERCEDES	9424204701	EFR7304	MERCEDES	9424212512	93087900
MERCEDES	9424204801	EFR7305	MERCEDES	9424212512	DF70000

Les correspondances de références ont pour seul objectif d'aider la recherche de référence

Cross references are there for the sole purpose of helping the reference search

CORRESPONDANCES DES REFERENCES CROSS REFERENCE LIST

MARQUE/MAKER	REF/PN OES	REF/PN	MARQUE/MAKER	REF/PN OES	REF/PN
MERCEDES	9424212512	FCR145A	MERCEDES	9444201302	EFR7351
MERCEDES	9424212612	09.B325.30	MERCEDES	9444201401	EFR7300
MERCEDES	9424212612	93087900	MERCEDES	9444201501	EFR7301
MERCEDES	9424212612	DF70000	MERCEDES	9444201601	EFR7300
MERCEDES	9424212612	FCR145A	MERCEDES	9444201701	EFR7301
MERCEDES	9424230012	09.B325.30	MERCEDES	9444202001	EFR7300
MERCEDES	9424230012	93087900	MERCEDES	9444202101	EFR7301
MERCEDES	9424230012	DF70000	MERCEDES	9444202201	EFR7300
MERCEDES	9424230012	FCR145A	MERCEDES	9444202301	EFR7301
MERCEDES	9424230112	09.B325.30	MERCEDES	9444202401	EFR7300
MERCEDES	9424230112	93087900	MERCEDES	9444202501	EFR7301
MERCEDES	9424230112	DF70000	MERCEDES	9444202601	EFR7300
MERCEDES	9424230112	FCR145A	MERCEDES	9444202701	EFR7301
MERCEDES	9424230212	09.B325.30	MERCEDES	9444202801	EFR7300
MERCEDES	9424230212	93087900	MERCEDES	9444202901	EFR7301
MERCEDES	9424230212	DF70000	MERCEDES	9444203001	EFR7304
MERCEDES	9424230212	FCR145A	MERCEDES	9444203101	EFR7305
MERCEDES	9424231212	09.B325.30	MERCEDES	9444203201	EFR7304
MERCEDES	9424231212	93087900	MERCEDES	9444203301	EFR7305
MERCEDES	9424231212	DF70000	MERCEDES	9444203401	EFR7304
MERCEDES	9424231212	FCR145A	MERCEDES	9444203501	EFR7305
MERCEDES	9434210312	09.A741.10	MERCEDES	9444203601	EFR7304
MERCEDES	9434210312	93186700	MERCEDES	9444203701	EFR7305
MERCEDES	9434210312	DF70008	MERCEDES	9444203801	EFR7304
MERCEDES	9434210312	FCR323A	MERCEDES	9444203901	EFR7305
MERCEDES	9434210412	09.A741.10	MERCEDES	9444204001	EFR7304
MERCEDES	9434210412	93186700	MERCEDES	9444204101	EFR7305
MERCEDES	9434210412	DF70008	MERCEDES	9444204601	EFR7304
MERCEDES	9434210412	FCR323A	MERCEDES	9444204701	EFR7305
MERCEDES	9434210512	09.A741.10	MERCEDES	9444204801	EFR7304
MERCEDES	9434210512	93186700	MERCEDES	9444204901	EFR7305
MERCEDES	9434210512	DF70008	MERCEDES	9444205401	EFR7304
MERCEDES	9434210512	FCR323A	MERCEDES	9444205501	EFR7305
MERCEDES	9444200001	EFR7304	MERCEDES	9444205801	EFR7304
MERCEDES	9444200101	EFR7305	MERCEDES	9444205901	EFR7305
MERCEDES	9444200201	EFR7304	MERCEDES	9444206001	EFR7304
MERCEDES	9444200301	EFR7305	MERCEDES	9444206101	EFR7305
MERCEDES	9444200501	EFR7304	MERCEDES	9444206601	EFR7304
MERCEDES	9444200601	EFR7305	MERCEDES	9444206701	EFR7305
MERCEDES	9444200701	EFR7304	MERCEDES	9444206801	EFR7304
MERCEDES	9444200801	EFR7305	MERCEDES	9444206901	EFR7305
MERCEDES	9444201001	EFR7304	MERCEDES	9444207001	EFR7304
MERCEDES	9444201002	EFR7346	MERCEDES	9444207101	EFR7305
MERCEDES	9444201101	EFR7305	MERCEDES	9444207901	EFR7348
MERCEDES	9444201102	EFR7347	MERCEDES	9444208001	EFR7349
MERCEDES	9444201201	EFR7304	MERCEDES	9444208801	EFR7348
MERCEDES	9444201202	EFR7350	MERCEDES	9444208901	EFR7349
MERCEDES	9444201301	EFR7305	MERCEDES	9464200101	EFR6300

Les correspondances de références ont pour seul objectif d'aider la recherche de référence

Cross references are there for the sole purpose of helping the reference search

CORRESPONDANCES DES REFERENCES CROSS REFERENCE LIST

MARQUE/MAKER	REF/PN OES	REF/PN	MARQUE/MAKER	REF/PN OES	REF/PN
MERCEDES	9464200201	EFR6301	MERCEDES	9604210512	09.C311.10
MERCEDES	9464200301	EFR6300	MERCEDES	9604210512	93291200
MERCEDES	9464200401	EFR6301	MERCEDES	9604210512	FCR372A
MERCEDES	9464200501	EFR6300	MERCEDES	9704200401	EFR5302
MERCEDES	9464200601	EFR6301	MERCEDES	9704200501	EFR5303
MERCEDES	9464201001	EFR6300	MERCEDES	9704200701	EFR5300
MERCEDES	9464201101	EFR6301	MERCEDES	9704200801	EFR5301
MERCEDES	9464201301	EFR6300	MERCEDES	9704201001	EFR5006
MERCEDES	9464201401	EFR6301	MERCEDES	9704201101	EFR5007
MERCEDES	9464201501	EFR6300	MERCEDES	9704201201	EFR5302
MERCEDES	9464201601	EFR6301	MERCEDES	9704201301	EFR5303
MERCEDES	9464201701	EFR6300	MERCEDES	9704201401	EFR5300
MERCEDES	9464201801	EFR6301	MERCEDES	9704201501	EFR5301
MERCEDES	9464201901	EFR6300	MERCEDES	9704201601	EFR5302
MERCEDES	9464202001	EFR6301	MERCEDES	9704201701	EFR5303
MERCEDES	9464202201	EFR6308	MERCEDES	9704201801	EFR5300
MERCEDES	9464202301	EFR6309	MERCEDES	9704201901	EFR5301
MERCEDES	9494200301	EFR7305	MERCEDES	9704202001	EFR5302
MERCEDES	9494200401	EFR7304	MERCEDES	9704202101	EFR5303
MERCEDES	9494200501	EFR7305	MERCEDES	9704202201	EFR5302
MERCEDES	9494200601	EFR7304	MERCEDES	9704202301	EFR5303
MERCEDES	9494200701	EFR7305	MERCEDES	9704202401	EFR5302
MERCEDES	9494200801	EFR7304	MERCEDES	9704202501	EFR5006
MERCEDES	9494200901	EFR7305	MERCEDES	9704202601	EFR5007
MERCEDES	9494201001	EFR7304	MERCEDES	9704203301	EFR6306
MERCEDES	9494201101	EFR7305	MERCEDES	9704203401	EFR6307
MERCEDES	9494201201	EFR7304	MERCEDES	9704203501	EFR6305
MERCEDES	9494201301	EFR7305	MERCEDES	9704203601	EFR6304
MERCEDES	9494202201	EFR7305	MERCEDES	9704203901	EFR5302
MERCEDES	9494202301	EFR7304	MERCEDES	9704204001	EFR5303
MERCEDES	9494202401	EFR7305	MERCEDES	9704204101	EFR5302
MERCEDES	9494202501	EFR7304	MERCEDES	9704204201	EFR5303
MERCEDES	9494203301	EFR7304	MERCEDES	9704204301	EFR5300
MERCEDES	9494203401	EFR7305	MERCEDES	9704204401	EFR5301
MERCEDES	9494203701	EFR7304	MERCEDES	9704204501	EFR5300
MERCEDES	9494203801	EFR7305	MERCEDES	9704204601	EFR5301
MERCEDES	9604200102	EFR7346	MERCEDES	9704204801	EFR5300
MERCEDES	9604200202	EFR7347	MERCEDES	9704204901	EFR5301
MERCEDES	9604200420	2931501	MERCEDES	9704205001	EFR5302
MERCEDES	9604200420	29315FLE1749	MERCEDES	9704205101	EFR5303
MERCEDES	9604200501	EFR7352	MERCEDES	9704205201	EFR6306
MERCEDES	9604200601	EFR7353	MERCEDES	9704205301	EFR6307
MERCEDES	9604210312	09.C311.10	MERCEDES	9704205401	EFR6305
MERCEDES	9604210312	93291200	MERCEDES	9704205501	EFR6304
MERCEDES	9604210312	FCR372A	MERCEDES	9704210012	09.8574.10
MERCEDES	9604210412	09.C311.10	MERCEDES	9704210012	93101300
MERCEDES	9604210412	93291200	MERCEDES	9704210012	FCR186A
MERCEDES	9604210412	FCR372A	MERCEDES	9704210112	09.8574.10

Les correspondances de références ont pour seul objectif d'aider la recherche de référence

Cross references are there for the sole purpose of helping the reference search

CORRESPONDANCES DES REFERENCES CROSS REFERENCE LIST

MARQUE/MAKER	REF/PN OES	REF/PN	MARQUE/MAKER	REF/PN OES	REF/PN
MERCEDES	9704210112	93101300	MERCEDES	9724206701	EFR7300
MERCEDES	9704210112	FCR186A	MERCEDES	9724206801	EFR7301
MERCEDES	9704210212	09.8574.10	MERCEDES	9754200401	EFR6305
MERCEDES	9704210212	93101300	MERCEDES	9754200501	EFR6304
MERCEDES	9704210212	FCR186A	MERCEDES	9754200701	EFR6306
MERCEDES	9704210612	09.8574.10	MERCEDES	9754200801	EFR6307
MERCEDES	9704210612	93101300	MERCEDES	9754200901	EFR6305
MERCEDES	9704210612	FCR186A	MERCEDES	9754201001	EFR6304
MERCEDES	9704210712	09.8574.10	MERCEDES	9754201101	EFR6306
MERCEDES	9704210712	93101300	MERCEDES	9754201201	EFR6307
MERCEDES	9704210712	FCR186A	MERCEDES	9754201301	EFR6305
MERCEDES	9704230012	09.9182.10	MERCEDES	9754201401	EFR6304
MERCEDES	9704230012	93102400	MERCEDES	9754201501	EFR6306
MERCEDES	9704230012	FCR188A	MERCEDES	9754201601	EFR6307
MERCEDES	9704230212	93127700	MERCEDES	9754201801	EFR6305
MERCEDES	9704230212	FCR216A	MERCEDES	9754201901	EFR6304
MERCEDES	9704230312	09.9181.10	MERCEDES	9754202001	EFR6305
MERCEDES	9704230312	93102300	MERCEDES	9754202101	EFR6304
MERCEDES	9704230312	FCR187A	MERCEDES	9754202201	EFR6305
MERCEDES	9704230412	09.9181.10	MERCEDES	9754202301	EFR6304
MERCEDES	9704230412	93102300	MERCEDES	9754202401	EFR6305
MERCEDES	9704230412	FCR187A	MERCEDES	9754202501	EFR6304
MERCEDES	9704230512	09.9182.10	MERCEDES	9754202601	EFR6301
MERCEDES	9704230512	93102400	MERCEDES	9754202701	EFR6300
MERCEDES	9704230512	FCR188A	MERCEDES	9754202801	EFR6301
MERCEDES	9704230612	09.9181.10	MERCEDES	9754202901	EFR6300
MERCEDES	9704230612	93102300	MERCEDES	9754203301	EFR7304
MERCEDES	9704230612	FCR187A	MERCEDES	9754203401	EFR7305
MERCEDES	9704230712	09.9182.10	MERCEDES	9754203701	EFR6626
MERCEDES	9704230712	93102400	MERCEDES	9754203801	EFR6627
MERCEDES	9704230712	FCR188A	MERCEDES	9754203901	EFR6626
MERCEDES	9704231112	09.9182.10	MERCEDES	9754204001	EFR6627
MERCEDES	9704231112	93102400	MERCEDES	9754204401	EFR6620
MERCEDES	9704231112	FCR188A	MERCEDES	9754204501	EFR6621
MERCEDES	9704231212	09.9181.10	MERCEDES	9754204601	EFR6620
MERCEDES	9704231212	93102300	MERCEDES	9754204701	EFR6621
MERCEDES	9704231212	FCR187A	MERCEDES	9754204801	EFR6305
MERCEDES	9704232112	09.9182.10	MERCEDES	9754204901	EFR6304
MERCEDES	9704232112	93102400	MERCEDES	9754205001	EFR6305
MERCEDES	9704232112	FCR188A	MERCEDES	9754205101	EFR6304
MERCEDES	9724200501	EFR7618	MERCEDES	9754205201	EFR6307
MERCEDES	9724200601	EFR7619	MERCEDES	9754205301	EFR6306
MERCEDES	9724200701	EFR7618	MERCEDES	9754205401	EFR6307
MERCEDES	9724200801	EFR7619	MERCEDES	9754205501	EFR6306
MERCEDES	9724201101	EFR7618	MERCEDES	9754206101	EFR6306
MERCEDES	9724201201	EFR7619	MERCEDES	9754206201	EFR6307
MERCEDES	9724201301	EFR7618	MERCEDES	9754206301	EFR6306
MERCEDES	9724201401	EFR7619	MERCEDES	9754206401	EFR6307

Les correspondances de références ont pour seul objectif d'aider la recherche de référence

Cross references are there for the sole purpose of helping the reference search

CORRESPONDANCES DES REFERENCES CROSS REFERENCE LIST

MARQUE/MAKER	REF/PN OES	REF/PN	MARQUE/MAKER	REF/PN OES	REF/PN
MERCEDES	9754206501	EFR6305	MERCEDES	A0004204382	CAC025
MERCEDES	9754206601	EFR6304	MERCEDES	A0004204582	CAC026
MERCEDES	9754206701	EFR6305	MERCEDES	A0004204682	CAC007
MERCEDES	9754206801	EFR6304	MERCEDES	A0004204882	CAC008
MERCEDES	9754207001	EFR6306	MERCEDES	A0004204982	CAC009
MERCEDES	9754207101	EFR6307	MERCEDES	A0004205082	CAC026
MERCEDES	9754207201	EFR6306	MERCEDES	A0004205682	CAC026
MERCEDES	9754207301	EFR6307	MERCEDES	A0004210312	93101200
MERCEDES	9754207601	EFR6305	MERCEDES	A0004210510	2920200604
MERCEDES	9754207701	EFR6304	MERCEDES	A0004210510	2925305390
MERCEDES	9754210012	09.8573.10	MERCEDES	A0004210510	2927801
MERCEDES	9754210012	93101400	MERCEDES	A0004210510	2927802
MERCEDES	9754210012	FCR189A	MERCEDES	A0004210510	CVP020K
MERCEDES	9754210112	09.8573.10	MERCEDES	A0004210710	2932003
MERCEDES	9754210112	93101400	MERCEDES	A0004210710	2932004
MERCEDES	9754210112	FCR189A	MERCEDES	A0004210710	2936101
MERCEDES	9754210212	09.8573.10	MERCEDES	A0004210710	CVP036K
MERCEDES	9754210212	93101400	MERCEDES	A0004210810	2932003
MERCEDES	9754210212	FCR189A	MERCEDES	A0004210810	2936101
MERCEDES	9754210512	09.8573.10	MERCEDES	A0004210810	CVP036K
MERCEDES	9754210512	93101400	MERCEDES	A0004211010	2918302
MERCEDES	9754210512	FCR189A	MERCEDES	A0004211210	2918302
MERCEDES	9754230012	09.8925.10	MERCEDES	A0004211810	2920200604
MERCEDES	9754230012	93101500	MERCEDES	A0004211810	2927801
MERCEDES	9754230012	FCR190A	MERCEDES	A0004211810	2927802
MERCEDES	9754230312	09.8925.10	MERCEDES	A0004211810	CVP020K
MERCEDES	9754230312	93101500	MERCEDES	A0004213712	09.A741.10
MERCEDES	9754230312	FCR190A	MERCEDES	A0004213712	93186700
MERCEDES	9754230612	09.8925.10	MERCEDES	A0004213712	DF70008
MERCEDES	9754230612	93101500	MERCEDES	A0004213712	FCR323A
MERCEDES	9754230612	FCR190A	MERCEDES	A0004214310	2920200604
MERCEDES	9757201601	EFR6307	MERCEDES	A0004214310	2925305390
MERCEDES	9794200101	EFR5302	MERCEDES	A0004214310	2927801
MERCEDES	9794200201	EFR5303	MERCEDES	A0004214310	2927802
MERCEDES	A0004200272	93101200	MERCEDES	A0004214310	CVP020K
MERCEDES	A0004200312	93101200	MERCEDES	A0004215010	2932003
MERCEDES	A0004200682	CAC008	MERCEDES	A0004215010	2936101
MERCEDES	A0004200782	CAC005	MERCEDES	A0004215010	CVP036K
MERCEDES	A0004201282	CAC005	MERCEDES	A0004230316	CAC043
MERCEDES	A0004202282	CAC005	MERCEDES	A0004232412	09.B325.30
MERCEDES	A0004202282	CAC010	MERCEDES	A0004232412	93087900
MERCEDES	A0004202382	CAC009	MERCEDES	A0004232412	DF70000
MERCEDES	A0004202982	CAC024	MERCEDES	A0004232412	FCR145A
MERCEDES	A0004202982	CAC042	MERCEDES	A0004232774	CAC024
MERCEDES	A0004203482	CAC007	MERCEDES	A0004232774	CAC042
MERCEDES	A0004203982	CAC008	MERCEDES	A0004236610	2920200604
MERCEDES	A0004204082	CAC009	MERCEDES	A0004236610	2927801
MERCEDES	A0004204282	CAC009	MERCEDES	A0004236610	2927802

Les correspondances de références ont pour seul objectif d'aider la recherche de référence

Cross references are there for the sole purpose of helping the reference search

CORRESPONDANCES DES REFERENCES CROSS REFERENCE LIST

MARQUE/MAKER	REF/PN OES	REF/PN	MARQUE/MAKER	REF/PN OES	REF/PN
MERCEDES	A0004236610	CVP020K	MERCEDES	A0014213610	CVP020K
MERCEDES	A0014200501	EFR7300	MERCEDES	A0014215210	2931501
MERCEDES	A0014200601	EFR7301	MERCEDES	A0014215210	29315FLE1749
MERCEDES	A0014200701	EFR7300	MERCEDES	A0024200383	CAC010
MERCEDES	A0014200801	EFR7301	MERCEDES	A0024200820	2908302
MERCEDES	A0014201001	EFR7300	MERCEDES	A0024200820	CVP013K
MERCEDES	A0014201101	EFR7301	MERCEDES	A0024201401	EFR5300
MERCEDES	A0014201401	EFR6307	MERCEDES	A00242014010080	EFR5300
MERCEDES	A0014201501	EFR6306	MERCEDES	A0024201483	EFR7304
MERCEDES	A0014202101	EFR5300	MERCEDES	A00242014830080	EFR7304
MERCEDES	A0014202201	EFR5301	MERCEDES	A002420148310	EFR7304
MERCEDES	A0014202301	EFR7304	MERCEDES	A002420148380	EFR7304
MERCEDES	A0014202401	EFR7305	MERCEDES	A0024201501	EFR5301
MERCEDES	A0014202501	EFR7304	MERCEDES	A00242015010080	EFR5301
MERCEDES	A00142025010080	EFR7304	MERCEDES	A0024201583	EFR7305
MERCEDES	A0014202601	EFR7305	MERCEDES	A00242015830080	EFR7305
MERCEDES	A00142026010080	EFR7305	MERCEDES	A002420158310	EFR7305
MERCEDES	A0014204401	EFR7316	MERCEDES	A002420158380	EFR7305
MERCEDES	A0014204501	EFR7317	MERCEDES	A0024201601	EFR5302
MERCEDES	A0014205001	EFR7316	MERCEDES	A00242016010080	EFR5302
MERCEDES	A0014205101	EFR7317	MERCEDES	A0024201701	EFR5303
MERCEDES	A0014205201	EFR7304	MERCEDES	A00242017010080	EFR5303
MERCEDES	A0014205283	CAC005	MERCEDES	A0024201801	EFR6306
MERCEDES	A0014205301	EFR7305	MERCEDES	A0024201901	EFR6307
MERCEDES	A0014205701	EFR6304	MERCEDES	A0024202001	EFR6305
MERCEDES	A0014205801	EFR6305	MERCEDES	A0024202101	EFR6304
MERCEDES	A0014205901	EFR6304	MERCEDES	A0024202201	EFR6307
MERCEDES	A0014206001	EFR6305	MERCEDES	A0024202220	2927801
MERCEDES	A0014206101	EFR6301	MERCEDES	A002420222010	2920200604
MERCEDES	A00142061010080	EFR6301	MERCEDES	A002420222010	2925305390
MERCEDES	A0014206201	EFR6300	MERCEDES	A002420222010	2927801
MERCEDES	A0014206201	EFR6301	MERCEDES	A002420222010	2927802
MERCEDES	A00142062010080	EFR6300	MERCEDES	A002420222010	CVP020K
MERCEDES	A0014206301	EFR5302	MERCEDES	A0024202301	EFR6306
MERCEDES	A0014206401	EFR5303	MERCEDES	A0024202401	EFR6304
MERCEDES	A0014206901	EFR7304	MERCEDES	A0024202501	EFR6305
MERCEDES	A0014207001	EFR7305	MERCEDES	A0024202601	EFR6300
MERCEDES	A0014210510	2918302	MERCEDES	A00242026010080	EFR6300
MERCEDES	A0014210610	2918302	MERCEDES	A0024202701	EFR6301
MERCEDES	A0014211710	2932002	MERCEDES	A00242027010080	EFR6301
MERCEDES	A0014211710	2932003	MERCEDES	A0024203001	EFR6307
MERCEDES	A0014211710	2932004	MERCEDES	A0024203101	EFR6306
MERCEDES	A0014211710	2936101	MERCEDES	A0024203201	EFR6304
MERCEDES	A0014211710	CVP036K	MERCEDES	A0024203301	EFR6305
MERCEDES	A0014212510	2918302	MERCEDES	A0024203401	EFR6306
MERCEDES	A0014212610	2918302	MERCEDES	A0024203501	EFR6307
MERCEDES	A0014213610	2920200604	MERCEDES	A00242035010080	EFR6307
MERCEDES	A0014213610	2927802	MERCEDES	A0024203601	EFR6305

Les correspondances de références ont pour seul objectif d'aider la recherche de référence

Cross references are there for the sole purpose of helping the reference search

CORRESPONDANCES DES REFERENCES CROSS REFERENCE LIST

MARQUE/MAKER	REF/PN OES	REF/PN	MARQUE/MAKER	REF/PN OES	REF/PN
MERCEDES	A00242036010080	EFR6305	MERCEDES	A0024208183	EFR7304
MERCEDES	A0024203683	EFR6300	MERCEDES	A0024208283	EFR7305
MERCEDES	A0024203701	EFR6304	MERCEDES	A0024208583	EFR7310
MERCEDES	A00242037010080	EFR6304	MERCEDES	A0024208683	EFR7311
MERCEDES	A0024203783	EFR6301	MERCEDES	A0024208901	EFR5302
MERCEDES	A0024203883	EFR7304	MERCEDES	A0024209001	EFR5303
MERCEDES	A00242038830080	EFR7304	MERCEDES	A0024209283	EFR7310
MERCEDES	A0024203983	EFR7305	MERCEDES	A0024209983	EFR7311
MERCEDES	A00242039830080	EFR7305	MERCEDES	A0034201020	2920200604
MERCEDES	A0024204101	EFR6307	MERCEDES	A0034201020	2927801
MERCEDES	A00242041010080	EFR6307	MERCEDES	A0034201020	2927802
MERCEDES	A0024204201	EFR6306	MERCEDES	A0034201020	CVP020K
MERCEDES	A00242042010080	EFR6306	MERCEDES	A0034201120	2918302
MERCEDES	A0024204301	EFR6304	MERCEDES	A0034201220	2918302
MERCEDES	A00242043010080	EFR6304	MERCEDES	A0034201620	2920200604
MERCEDES	A0024204401	EFR6305	MERCEDES	A0034201620	2925305390
MERCEDES	A00242044010080	EFR6305	MERCEDES	A0034201620	2927801
MERCEDES	A0024204501	EFR7304	MERCEDES	A0034201620	2927802
MERCEDES	A00242045010080	EFR7304	MERCEDES	A0034201620	CVP020K
MERCEDES	A0024204601	EFR7305	MERCEDES	A0034202020	2920200604
MERCEDES	A00242046010080	EFR7305	MERCEDES	A0034202020	2925305390
MERCEDES	A0024204920	2920200604	MERCEDES	A0034202020	2927801
MERCEDES	A0024204920	2925305390	MERCEDES	A0034202020	2927802
MERCEDES	A0024204920	2927801	MERCEDES	A0034202020	CVP020K
MERCEDES	A0024204920	2927802	MERCEDES	A0034202220	2920200604
MERCEDES	A0024204920	CVP020K	MERCEDES	A0034202220	2925305390
MERCEDES	A0024204983	EFR7300	MERCEDES	A0034202220	2927801
MERCEDES	A00242049830080	EFR7300	MERCEDES	A0034202220	CVP020K
MERCEDES	A0024205083	EFR7301	MERCEDES	A0034203520	2920200604
MERCEDES	A00242050830080	EFR7301	MERCEDES	A0034203520	2925305390
MERCEDES	A0024205183	EFR7316	MERCEDES	A0034203520	2927801
MERCEDES	A0024205283	EFR7317	MERCEDES	A0034203520	2927802
MERCEDES	A0024205520	2908302	MERCEDES	A0034203520	CVP020K
MERCEDES	A0024205520	CVP013K	MERCEDES	A0034206620	2918302
MERCEDES	A0024206601	EFR7304	MERCEDES	A0034207220	2918302
MERCEDES	A0024206701	EFR7305	MERCEDES	A0034207320	2918302
MERCEDES	A0024207020	2920200604	MERCEDES	A0034208420	2903009
MERCEDES	A0024207020	2927801	MERCEDES	A0034208420	CVP013K
MERCEDES	A0024207020	2927802	MERCEDES	A0034209183	EFR6308
MERCEDES	A0024207020	CVP020K	MERCEDES	A00342091830080	EFR6308
MERCEDES	A0024207820	2932003	MERCEDES	A0034209283	EFR6309
MERCEDES	A0024207820	2932004	MERCEDES	A00342092830080	EFR6309
MERCEDES	A0024207820	2936101	MERCEDES	A0044201320	2932002
MERCEDES	A0024207820	CVP036K	MERCEDES	A0044201320	2932003
MERCEDES	A0024207920	2932003	MERCEDES	A0044201320	CVP036K
MERCEDES	A0024207920	2932004	MERCEDES	A0044202220	2920200604
MERCEDES	A0024207920	2936101	MERCEDES	A0044202220	2925305390
MERCEDES	A0024207920	CVP036K	MERCEDES	A0044202220	2927801

Les correspondances de références ont pour seul objectif d'aider la recherche de référence

Cross references are there for the sole purpose of helping the reference search

CORRESPONDANCES DES REFERENCES CROSS REFERENCE LIST

MARQUE/MAKER	REF/PN OES	REF/PN	MARQUE/MAKER	REF/PN OES	REF/PN
MERCEDES	A0044202220	2927802	MERCEDES	A0054203983	EFR7010
MERCEDES	A0044202220	CVP020K	MERCEDES	A0054204083	EFR7011
MERCEDES	A0044202583	EFR7300	MERCEDES	A0064201020	2920200604
MERCEDES	A00442025830080	EFR7300	MERCEDES	A0064201020	2925305390
MERCEDES	A0044202683	EFR7301	MERCEDES	A0064201020	2927801
MERCEDES	A00442026830080	EFR7301	MERCEDES	A0064201020	2927802
MERCEDES	A0044206020	2920200604	MERCEDES	A0064201020	CVP020K
MERCEDES	A0044206020	2925305390	MERCEDES	A0064201120	2920200604
MERCEDES	A0044206020	2927801	MERCEDES	A0064201120	2925305390
MERCEDES	A0044206020	2927802	MERCEDES	A0064201120	2927801
MERCEDES	A0044206020	CVP020K	MERCEDES	A0064201120	CVP020K
MERCEDES	A0044206120	2918302	MERCEDES	A0064201420	2924601
MERCEDES	A0044207020	2925705390	MERCEDES	A0064201420	FCV4417PTS
MERCEDES	A0044207020	2926900604	MERCEDES	A0064201520	2924401
MERCEDES	A0044207020	2926901	MERCEDES	A0064201520	FCV4418PTS
MERCEDES	A0044207020	FCV4461PTS	MERCEDES	A0064205220	2924601
MERCEDES	A0044207383	EFR7348	MERCEDES	A0064205220	FCV4417PTS
MERCEDES	A00442073830080	EFR7348	MERCEDES	A0064205320	2924401
MERCEDES	A0044207483	EFR7349	MERCEDES	A0064205320	FCV4418PTS
MERCEDES	A00442074830080	EFR7349	MERCEDES	A0084205820	2932003
MERCEDES	A004420750080	EFR7346	MERCEDES	A0084205820	2932004
MERCEDES	A0044207583	EFR7346	MERCEDES	A0084205820	2936101
MERCEDES	A004420760080	EFR7347	MERCEDES	A0084205820	CVP036K
MERCEDES	A0044207683	EFR7347	MERCEDES	A0084205920	2932003
MERCEDES	A004420770080	EFR7350	MERCEDES	A0084205920	2936101
MERCEDES	A0044207783	EFR7350	MERCEDES	A0084205920	CVP036K
MERCEDES	A004420780080	EFR7351	MERCEDES	A0084206020	2920200604
MERCEDES	A0044207883	EFR7351	MERCEDES	A0084206020	2925305390
MERCEDES	A0044207983	EFR7345	MERCEDES	A0084206020	2927801
MERCEDES	A00442079830080	EFR7345	MERCEDES	A0084206020	2927802
MERCEDES	A0044208083	EFR7344	MERCEDES	A0084206020	CVP020K
MERCEDES	A00442080830080	EFR7344	MERCEDES	A0084206320	2931501
MERCEDES	A0044209383	EFR7304	MERCEDES	A0084206320	29315FLE1749
MERCEDES	A0044209483	EFR7305	MERCEDES	A0084206420	2931501
MERCEDES	A0044214310	2920200604	MERCEDES	A0084206420	29315FLE1749
MERCEDES	A0044214310	2925305390	MERCEDES	A0084206520	2918302
MERCEDES	A0044214310	2927802	MERCEDES	A0084206620	2918302
MERCEDES	A0044214310	CVP020K	MERCEDES	A0084207320	2924401
MERCEDES	A0054200583	EFR7352	MERCEDES	A0084207320	FCV4418PTS
MERCEDES	A0054201583	EFR7010	MERCEDES	A0104216298	EFR7316
MERCEDES	A0054201683	EFR7011	MERCEDES	A0104216398	EFR7317
MERCEDES	A0054201783	EFR6305	MERCEDES	A0104218898	EFR7316
MERCEDES	A0054201883	EFR6304	MERCEDES	A0104218998	EFR7317
MERCEDES	A0054202320	2932003	MERCEDES	A3564202501	EFR7604
MERCEDES	A0054202320	2932004	MERCEDES	A3564202601	EFR7605
MERCEDES	A0054202320	2936101	MERCEDES	A3564202801	EFR7608
MERCEDES	A0054202320	CVP036K	MERCEDES	A3564210312	09.8129.10
MERCEDES	A0054203283	EFR7313	MERCEDES	A3564210312	93058200

Les correspondances de références ont pour seul objectif d'aider la recherche de référence

Cross references are there for the sole purpose of helping the reference search

CORRESPONDANCES DES REFERENCES CROSS REFERENCE LIST

MARQUE/MAKER	REF/PN OES	REF/PN	MARQUE/MAKER	REF/PN OES	REF/PN
MERCEDES	A3564210312	FCR120A	MERCEDES	A6294200101	EFR7312
MERCEDES	A3564211012	09.8129.10	MERCEDES	A6294200102	EFR7342
MERCEDES	A3564211012	93058200	MERCEDES	A6294200201	EFR7313
MERCEDES	A3564211012	FCR120A	MERCEDES	A6294200202	EFR7343
MERCEDES	A3564211212	09.8129.10	MERCEDES	A6294200301	EFR7312
MERCEDES	A3564211212	93058200	MERCEDES	A6294200302	EFR7342
MERCEDES	A3564211212	FCR120A	MERCEDES	A6294200401	EFR7313
MERCEDES	A3565400017	98017200	MERCEDES	A6294200402	EFR7343
MERCEDES	A4054200020	2913401	MERCEDES	A6294200502	EFR7342
MERCEDES	A4054200220	2913401	MERCEDES	A6294200601	EFR7312
MERCEDES	A4054202020	2913401	MERCEDES	A6294200602	EFR7343
MERCEDES	A4054210016	CAC020	MERCEDES	A6294200701	EFR7313
MERCEDES	A4054210016	CAC021	MERCEDES	A6294200801	EFR7312
MERCEDES	A4054210498	EFR6124	MERCEDES	A6294200901	EFR7313
MERCEDES	A4054210598	EFR6125	MERCEDES	A6294201101	EFR7312
MERCEDES	A4104200202	EFR7343	MERCEDES	A6294201201	EFR7313
MERCEDES	A4104200302	EFR7342	MERCEDES	A6294201202	EFR7343
MERCEDES	A442073830080	EFR7348	MERCEDES	A6294201301	EFR7312
MERCEDES	A442074830080	EFR7349	MERCEDES	A6294201302	EFR7343
MERCEDES	A4420750080	EFR7346	MERCEDES	A6294201401	EFR7313
MERCEDES	A4420760080	EFR7347	MERCEDES	A6294201501	EFR7312
MERCEDES	A4420770080	EFR7350	MERCEDES	A6294201502	EFR7343
MERCEDES	A4420780080	EFR7351	MERCEDES	A6294201601	EFR7313
MERCEDES	A6270000042	EFR7606	MERCEDES	A6294201602	EFR7342
MERCEDES	A6270000142	EFR7607	MERCEDES	A6294300090	EFR7304
MERCEDES	A6270000442	EFR7606	MERCEDES	A6294300190	EFR7305
MERCEDES	A6270000542	EFR7607	MERCEDES	A6294300290	EFR7304
MERCEDES	A6270005642	EFR7606	MERCEDES	A6294300390	EFR7305
MERCEDES	A6270005742	EFR7607	MERCEDES	A6294300490	EFR7311
MERCEDES	A6274210012	09.8129.20	MERCEDES	A6294300590	EFR7310
MERCEDES	A6274210012	93058100	MERCEDES	A638421011205	09.8574.10
MERCEDES	A6274210012	FCR114A	MERCEDES	A638421011205	93101300
MERCEDES	A6274300090	EFR7303	MERCEDES	A638421011205	FCR186A
MERCEDES	A6274300190	EFR7302	MERCEDES	A6754210012	93276800
MERCEDES	A6274300290	EFR7315	MERCEDES	A6754210012	FCR346A
MERCEDES	A6274300390	EFR7314	MERCEDES	A6754210112	09.8573.10
MERCEDES	A6274300490	EFR7315	MERCEDES	A6754210112	93101400
MERCEDES	A6274300590	EFR7314	MERCEDES	A6754210112	FCR189A
MERCEDES	A6284200101	EFR7304	MERCEDES	A6754230312	09.8925.10
MERCEDES	A6284200201	EFR7305	MERCEDES	A6754230312	93101500
MERCEDES	A6284200701	EFR7304	MERCEDES	A6754230312	FCR190A
MERCEDES	A6284200801	EFR7305	MERCEDES	A6764200924	EFR7304
MERCEDES	A6284201101	EFR7304	MERCEDES	A6764201024	EFR7305
MERCEDES	A6284201201	EFR7305	MERCEDES	A6934200120	2927801
MERCEDES	A6284201601	EFR7304	MERCEDES	A6954230512	09.B325.30
MERCEDES	A6284201701	EFR7305	MERCEDES	A6954230512	93087900
MERCEDES	A6284201901	EFR7304	MERCEDES	A6954230512	DF70000
MERCEDES	A6284202001	EFR7305	MERCEDES	A6954230512	FCR145A

Les correspondances de références ont pour seul objectif d'aider la recherche de référence

Cross references are there for the sole purpose of helping the reference search

CORRESPONDANCES DES REFERENCES CROSS REFERENCE LIST

MARQUE/MAKER	REF/PN OES	REF/PN	MARQUE/MAKER	REF/PN OES	REF/PN
MERCEDES	A6964200601	EFR7312	MERCEDES	A9424201201	EFR7304
MERCEDES	A6964200701	EFR7313	MERCEDES	A9424201301	EFR7305
MERCEDES	A6964200801	EFR7312	MERCEDES	A9424201401	EFR7304
MERCEDES	A6964200901	EFR7313	MERCEDES	A9424201501	EFR7305
MERCEDES	A6964201101	EFR7312	MERCEDES	A9424201601	EFR7304
MERCEDES	A6964201201	EFR7313	MERCEDES	A9424201701	EFR7305
MERCEDES	A6964201301	EFR7312	MERCEDES	A9424201901	EFR7304
MERCEDES	A6964201401	EFR7313	MERCEDES	A9424202001	EFR7305
MERCEDES	A6964202101	EFR6305	MERCEDES	A9424202101	EFR7304
MERCEDES	A6964202201	EFR6304	MERCEDES	A9424202201	EFR7305
MERCEDES	A6964202601	EFR7304	MERCEDES	A9424202301	EFR7304
MERCEDES	A6964202701	EFR7305	MERCEDES	A9424202401	EFR7305
MERCEDES	A6964203001	EFR7308	MERCEDES	A9424202501	EFR7300
MERCEDES	A6964203101	EFR7309	MERCEDES	A9424202601	EFR7301
MERCEDES	A6964203401	EFR7304	MERCEDES	A9424202701	EFR7304
MERCEDES	A6964203501	EFR7305	MERCEDES	A9424202801	EFR7305
MERCEDES	A6964203701	EFR7309	MERCEDES	A9424202901	EFR7300
MERCEDES	A6964203801	EFR7308	MERCEDES	A9424203001	EFR7301
MERCEDES	A6964203901	EFR7310	MERCEDES	A9424203101	EFR7304
MERCEDES	A6964204001	EFR7311	MERCEDES	A9424203201	EFR7305
MERCEDES	A6964205301	EFR7310	MERCEDES	A9424203301	EFR7304
MERCEDES	A6964205401	EFR7311	MERCEDES	A9424203401	EFR7305
MERCEDES	A6964205501	EFR7310	MERCEDES	A9424203701	EFR7304
MERCEDES	A6964205601	EFR7311	MERCEDES	A9424203801	EFR7305
MERCEDES	A6964206201	EFR7304	MERCEDES	A9424203901	EFR7300
MERCEDES	A6964206301	EFR7305	MERCEDES	A9424204001	EFR7301
MERCEDES	A7404200001	EFR7310	MERCEDES	A9424204101	EFR7300
MERCEDES	A7404200101	EFR7311	MERCEDES	A9424204201	EFR7301
MERCEDES	A7404200201	EFR7308	MERCEDES	A9424204301	EFR7300
MERCEDES	A7404200301	EFR7309	MERCEDES	A9424204401	EFR7301
MERCEDES	A7494201001	EFR7304	MERCEDES	A9424204501	EFR7300
MERCEDES	A7494201101	EFR7305	MERCEDES	A9424204601	EFR7301
MERCEDES	A8285000589	09.B325.40	MERCEDES	A9424204701	EFR7304
MERCEDES	A8285000589	FCR168A	MERCEDES	A9424204801	EFR7305
MERCEDES	A9054200072	93191600	MERCEDES	A9424204901	EFR7304
MERCEDES	A9054200072	FCR300A	MERCEDES	A9424205001	EFR7305
MERCEDES	A9244211012	09.B325.30	MERCEDES	A9424205101	EFR7300
MERCEDES	A9244211012	93087900	MERCEDES	A9424205201	EFR7301
MERCEDES	A9244211012	DF70000	MERCEDES	A9424205601	EFR7304
MERCEDES	A9244211012	FCR145A	MERCEDES	A9424205701	EFR7305
MERCEDES	A9424200401	EFR7304	MERCEDES	A9424205801	EFR7304
MERCEDES	A9424200501	EFR7305	MERCEDES	A9424205901	EFR7305
MERCEDES	A9424200601	EFR7304	MERCEDES	A9424206001	EFR7304
MERCEDES	A9424200701	EFR7305	MERCEDES	A9424206101	EFR7305
MERCEDES	A9424200801	EFR7304	MERCEDES	A9424206201	EFR7304
MERCEDES	A9424200901	EFR7305	MERCEDES	A9424206301	EFR7305
MERCEDES	A9424201001	EFR7304	MERCEDES	A9424206501	EFR7300
MERCEDES	A9424201101	EFR7305	MERCEDES	A9424206503	EFR7300

Les correspondances de références ont pour seul objectif d'aider la recherche de référence

Cross references are there for the sole purpose of helping the reference search

CORRESPONDANCES DES REFERENCES CROSS REFERENCE LIST

MARQUE/MAKER	REF/PN OES	REF/PN	MARQUE/MAKER	REF/PN OES	REF/PN
MERCEDES	A9424206504	EFR7300	MERCEDES	A9424212512	FCR145A
MERCEDES	A9424206601	EFR7301	MERCEDES	A9424212612	09.B325.30
MERCEDES	A9424206603	EFR7301	MERCEDES	A9424212612	93087900
MERCEDES	A9424206604	EFR7301	MERCEDES	A9424212612	DF70000
MERCEDES	A9424206701	EFR7300	MERCEDES	A9424212612	FCR145A
MERCEDES	A9424206706	EFR7300	MERCEDES	A9424230012	09.B325.30
MERCEDES	A9424206801	EFR7301	MERCEDES	A9424230012	93087900
MERCEDES	A9424206805	EFR7301	MERCEDES	A9424230012	DF70000
MERCEDES	A9424206901	EFR7300	MERCEDES	A9424230012	FCR145A
MERCEDES	A9424207001	EFR7301	MERCEDES	A9424230112	09.B325.30
MERCEDES	A9424207101	EFR7300	MERCEDES	A9424230112	93087900
MERCEDES	A9424207201	EFR7301	MERCEDES	A9424230112	DF70000
MERCEDES	A9424207301	EFR7300	MERCEDES	A9424230112	FCR145A
MERCEDES	A9424207401	EFR7301	MERCEDES	A9424230212	09.B325.30
MERCEDES	A9424207501	EFR7300	MERCEDES	A9424230212	93087900
MERCEDES	A9424207601	EFR7301	MERCEDES	A9424230212	DF70000
MERCEDES	A9424207701	EFR7300	MERCEDES	A9424230212	FCR145A
MERCEDES	A9424207801	EFR7301	MERCEDES	A9424231212	09.B325.30
MERCEDES	A9424210912	09.B325.30	MERCEDES	A9424231212	93087900
MERCEDES	A9424210912	93087900	MERCEDES	A9424231212	DF70000
MERCEDES	A9424210912	DF70000	MERCEDES	A9424231212	FCR145A
MERCEDES	A9424210912	FCR145A	MERCEDES	A9434210312	09.A741.10
MERCEDES	A9424211012	09.B325.30	MERCEDES	A9434210312	93186700
MERCEDES	A9424211012	93087900	MERCEDES	A9434210312	DF70008
MERCEDES	A9424211012	DF70000	MERCEDES	A9434210312	FCR323A
MERCEDES	A9424211012	FCR145A	MERCEDES	A9434210412	09.A741.10
MERCEDES	A9424211112	09.B325.30	MERCEDES	A9434210412	93186700
MERCEDES	A9424211112	93087900	MERCEDES	A9434210412	DF70008
MERCEDES	A9424211112	DF70000	MERCEDES	A9434210412	FCR323A
MERCEDES	A9424211112	FCR145A	MERCEDES	A9434210512	09.A741.10
MERCEDES	A9424211212	09.B325.30	MERCEDES	A9434210512	93186700
MERCEDES	A9424211212	93087900	MERCEDES	A9434210512	DF70008
MERCEDES	A9424211212	DF70000	MERCEDES	A9434210512	FCR323A
MERCEDES	A9424211212	FCR145A	MERCEDES	A944 420 02 01	EFR7304
MERCEDES	A9424211312	09.8793.10	MERCEDES	A9444200001	EFR7304
MERCEDES	A9424211312	93101800	MERCEDES	A9444200101	EFR7305
MERCEDES	A9424211312	FCR201A	MERCEDES	A9444200201	EFR7304
MERCEDES	A9424212112	09.B325.30	MERCEDES	A9444200301	EFR7305
MERCEDES	A9424212112	93087900	MERCEDES	A9444200501	EFR7304
MERCEDES	A9424212112	DF70000	MERCEDES	A9444200601	EFR7305
MERCEDES	A9424212112	FCR145A	MERCEDES	A9444200701	EFR7304
MERCEDES	A9424212312	09.B325.30	MERCEDES	A9444200801	EFR7305
MERCEDES	A9424212312	93087900	MERCEDES	A9444201001	EFR7304
MERCEDES	A9424212312	DF70000	MERCEDES	A9444201002	EFR7346
MERCEDES	A9424212312	FCR145A	MERCEDES	A9444201101	EFR7305
MERCEDES	A9424212512	09.B325.30	MERCEDES	A9444201102	EFR7347
MERCEDES	A9424212512	93087900	MERCEDES	A9444201201	EFR7304
MERCEDES	A9424212512	DF70000	MERCEDES	A9444201202	EFR7350

Les correspondances de références ont pour seul objectif d'aider la recherche de référence

Cross references are there for the sole purpose of helping the reference search

CORRESPONDANCES DES REFERENCES CROSS REFERENCE LIST

MARQUE/MAKER	REF/PN OES	REF/PN	MARQUE/MAKER	REF/PN OES	REF/PN
MERCEDES	A9444201301	EFR7305	MERCEDES	A9444208801	EFR7348
MERCEDES	A9444201302	EFR7351	MERCEDES	A9444208901	EFR7349
MERCEDES	A9444201401	EFR7300	MERCEDES	A9444209001	EFR7300
MERCEDES	A9444201501	EFR7301	MERCEDES	A9444209101	EFR7301
MERCEDES	A9444201601	EFR7300	MERCEDES	A9444209201	EFR7300
MERCEDES	A9444201701	EFR7301	MERCEDES	A9444209301	EFR7301
MERCEDES	A9444201801	EFR7301	MERCEDES	A9444209401	EFR7300
MERCEDES	A9444201901	EFR7300	MERCEDES	A9444209501	EFR7301
MERCEDES	A9444202001	EFR7300	MERCEDES	A9444209601	EFR7300
MERCEDES	A9444202101	EFR7301	MERCEDES	A9444209701	EFR7301
MERCEDES	A9444202201	EFR7300	MERCEDES	A9449207901	EFR7348
MERCEDES	A9444202301	EFR7301	MERCEDES	A9449208001	EFR7349
MERCEDES	A9444202401	EFR7300	MERCEDES	A9464200101	EFR6300
MERCEDES	A9444202501	EFR7301	MERCEDES	A9464200201	EFR6301
MERCEDES	A9444202601	EFR7300	MERCEDES	A9464200301	EFR6300
MERCEDES	A9444202701	EFR7301	MERCEDES	A9464200401	EFR6301
MERCEDES	A9444202801	EFR7300	MERCEDES	A9464200501	EFR6300
MERCEDES	A9444202901	EFR7301	MERCEDES	A9464200601	EFR6301
MERCEDES	A9444203001	EFR7304	MERCEDES	A9464201001	EFR6300
MERCEDES	A9444203101	EFR7305	MERCEDES	A9464201101	EFR6301
MERCEDES	A9444203201	EFR7304	MERCEDES	A9464201301	EFR6300
MERCEDES	A9444203301	EFR7305	MERCEDES	A9464201401	EFR6301
MERCEDES	A9444203401	EFR7304	MERCEDES	A9464201501	EFR6300
MERCEDES	A9444203501	EFR7305	MERCEDES	A9464201601	EFR6301
MERCEDES	A9444203601	EFR7304	MERCEDES	A9464201701	EFR6300
MERCEDES	A9444203701	EFR7305	MERCEDES	A9464201801	EFR6301
MERCEDES	A9444203801	EFR7304	MERCEDES	A9464201901	EFR6300
MERCEDES	A9444203901	EFR7305	MERCEDES	A9464202001	EFR6301
MERCEDES	A9444204001	EFR7304	MERCEDES	A9464202201	EFR6308
MERCEDES	A9444204101	EFR7305	MERCEDES	A9464202301	EFR6309
MERCEDES	A9444204601	EFR7304	MERCEDES	A9494200301	EFR7305
MERCEDES	A9444204701	EFR7305	MERCEDES	A9494200401	EFR7304
MERCEDES	A9444204801	EFR7304	MERCEDES	A9494200501	EFR7305
MERCEDES	A9444204901	EFR7305	MERCEDES	A9494200601	EFR7304
MERCEDES	A9444205401	EFR7304	MERCEDES	A9494200701	EFR7305
MERCEDES	A9444205501	EFR7305	MERCEDES	A9494200801	EFR7304
MERCEDES	A9444205801	EFR7304	MERCEDES	A9494200901	EFR7305
MERCEDES	A9444205901	EFR7305	MERCEDES	A9494201001	EFR7304
MERCEDES	A9444206001	EFR7304	MERCEDES	A9494201101	EFR7305
MERCEDES	A9444206101	EFR7305	MERCEDES	A9494201201	EFR7304
MERCEDES	A9444206601	EFR7304	MERCEDES	A9494201301	EFR7305
MERCEDES	A9444206701	EFR7305	MERCEDES	A9494202201	EFR7305
MERCEDES	A9444206801	EFR7304	MERCEDES	A9494202301	EFR7304
MERCEDES	A9444206901	EFR7305	MERCEDES	A9494202401	EFR7305
MERCEDES	A9444207001	EFR7304	MERCEDES	A9494202501	EFR7304
MERCEDES	A9444207101	EFR7305	MERCEDES	A9494203301	EFR7304
MERCEDES	A9444207901	EFR7348	MERCEDES	A9494203401	EFR7305
MERCEDES	A9444208001	EFR7349	MERCEDES	A9494203701	EFR7304

Les correspondances de références ont pour seul objectif d'aider la recherche de référence

Cross references are there for the sole purpose of helping the reference search

CORRESPONDANCES DES REFERENCES CROSS REFERENCE LIST

MARQUE/MAKER	REF/PN OES	REF/PN	MARQUE/MAKER	REF/PN OES	REF/PN
MERCEDES	A9494203801	EFR7305	MERCEDES	A9704203901	EFR5302
MERCEDES	A9574200002	EFR7304	MERCEDES	A9704204001	EFR5303
MERCEDES	A9574200102	EFR7305	MERCEDES	A9704204101	EFR5302
MERCEDES	A9574200201	EFR7304	MERCEDES	A9704204201	EFR5303
MERCEDES	A9574200301	EFR7305	MERCEDES	A9704204301	EFR5300
MERCEDES	A9604200102	EFR7346	MERCEDES	A9704204401	EFR5301
MERCEDES	A9604200202	EFR7347	MERCEDES	A9704204501	EFR5300
MERCEDES	A9604200420	2931501	MERCEDES	A9704204601	EFR5301
MERCEDES	A9604200420	29315FLE1749	MERCEDES	A9704204801	EFR5300
MERCEDES	A9604200501	EFR7352	MERCEDES	A9704204901	EFR5301
MERCEDES	A9604200601	EFR7353	MERCEDES	A9704205001	EFR5302
MERCEDES	A9604201302	EFR7010	MERCEDES	A9704205101	EFR5303
MERCEDES	A9604201402	EFR7011	MERCEDES	A9704205201	EFR6306
MERCEDES	A9604201602	EFR7010	MERCEDES	A9704205301	EFR6307
MERCEDES	A9604201702	EFR7011	MERCEDES	A9704205401	EFR6305
MERCEDES	A9604210312	09.C311.10	MERCEDES	A9704205501	EFR6304
MERCEDES	A9604210312	93291200	MERCEDES	A9704205801	EFR6306
MERCEDES	A9604210312	FCR372A	MERCEDES	A9704205901	EFR6307
MERCEDES	A9604210412	09.C311.10	MERCEDES	A9704210012	09.8574.10
MERCEDES	A9604210412	93291200	MERCEDES	A9704210012	93101300
MERCEDES	A9604210412	FCR372A	MERCEDES	A9704210012	FCR186A
MERCEDES	A9604210512	09.C311.10	MERCEDES	A9704210112	09.8574.10
MERCEDES	A9604210512	93291200	MERCEDES	A9704210112	93101300
MERCEDES	A9604210512	FCR372A	MERCEDES	A9704210112	FCR186A
MERCEDES	A9704200401	EFR5302	MERCEDES	A9704210212	09.8574.10
MERCEDES	A9704200501	EFR5303	MERCEDES	A9704210212	93101300
MERCEDES	A9704200701	EFR5300	MERCEDES	A9704210212	FCR186A
MERCEDES	A9704200801	EFR5301	MERCEDES	A9704210612	09.8574.10
MERCEDES	A9704201001	EFR5006	MERCEDES	A9704210612	93101300
MERCEDES	A9704201101	EFR5007	MERCEDES	A9704210612	FCR186A
MERCEDES	A9704201201	EFR5302	MERCEDES	A9704210712	09.8574.10
MERCEDES	A9704201301	EFR5303	MERCEDES	A9704210712	93101300
MERCEDES	A9704201401	EFR5300	MERCEDES	A9704210712	FCR186A
MERCEDES	A9704201501	EFR5301	MERCEDES	A9704230012	09.9182.10
MERCEDES	A9704201601	EFR5302	MERCEDES	A9704230012	93102400
MERCEDES	A9704201701	EFR5303	MERCEDES	A9704230012	FCR188A
MERCEDES	A9704201801	EFR5300	MERCEDES	A9704230212	93127700
MERCEDES	A9704201901	EFR5301	MERCEDES	A9704230212	FCR216A
MERCEDES	A9704202001	EFR5302	MERCEDES	A9704230312	09.9181.10
MERCEDES	A9704202101	EFR5303	MERCEDES	A9704230312	93102300
MERCEDES	A9704202201	EFR5302	MERCEDES	A9704230312	FCR187A
MERCEDES	A9704202301	EFR5303	MERCEDES	A9704230412	09.9181.10
MERCEDES	A9704202501	EFR5006	MERCEDES	A9704230412	93102300
MERCEDES	A9704202601	EFR5007	MERCEDES	A9704230412	FCR187A
MERCEDES	A9704203301	EFR6306	MERCEDES	A9704230512	09.9182.10
MERCEDES	A9704203401	EFR6307	MERCEDES	A9704230512	93102400
MERCEDES	A9704203501	EFR6305	MERCEDES	A9704230512	FCR188A
MERCEDES	A9704203601	EFR6304	MERCEDES	A9704230612	09.9181.10

Les correspondances de références ont pour seul objectif d'aider la recherche de référence

Cross references are there for the sole purpose of helping the reference search

CORRESPONDANCES DES REFERENCES CROSS REFERENCE LIST

MARQUE/MAKER	REF/PN OES	REF/PN	MARQUE/MAKER	REF/PN OES	REF/PN
MERCEDES	A9704230612	93102300	MERCEDES	A9754203301	EFR7304
MERCEDES	A9704230612	FCR187A	MERCEDES	A9754203401	EFR7305
MERCEDES	A9704230712	09.9182.10	MERCEDES	A9754203701	EFR6626
MERCEDES	A9704230712	93102400	MERCEDES	A9754203801	EFR6627
MERCEDES	A9704230712	FCR188A	MERCEDES	A9754203901	EFR6626
MERCEDES	A9704231112	09.9182.10	MERCEDES	A9754204001	EFR6627
MERCEDES	A9704231112	93102400	MERCEDES	A9754204401	EFR6620
MERCEDES	A9704231112	FCR188A	MERCEDES	A9754204501	EFR6621
MERCEDES	A9704231212	09.9181.10	MERCEDES	A9754204601	EFR6620
MERCEDES	A9704231212	93102300	MERCEDES	A9754204701	EFR6621
MERCEDES	A9704231212	FCR187A	MERCEDES	A9754204801	EFR6305
MERCEDES	A9704232112	09.9182.10	MERCEDES	A9754204901	EFR6304
MERCEDES	A9704232112	93102400	MERCEDES	A9754205001	EFR6305
MERCEDES	A9704232112	FCR188A	MERCEDES	A9754205101	EFR6304
MERCEDES	A9724200501	EFR7618	MERCEDES	A9754205201	EFR6306
MERCEDES	A9724200601	EFR7619	MERCEDES	A9754205301	EFR6307
MERCEDES	A9724200701	EFR7618	MERCEDES	A9754205401	EFR6306
MERCEDES	A9724200801	EFR7619	MERCEDES	A9754205501	EFR6307
MERCEDES	A9724201101	EFR7618	MERCEDES	A9754206101	EFR6306
MERCEDES	A9724201201	EFR7619	MERCEDES	A9754206201	EFR6307
MERCEDES	A9724201301	EFR7618	MERCEDES	A9754206301	EFR6306
MERCEDES	A9724201401	EFR7619	MERCEDES	A9754206401	EFR6307
MERCEDES	A9724206701	EFR7300	MERCEDES	A9754206501	EFR6305
MERCEDES	A9724206801	EFR7301	MERCEDES	A9754206601	EFR6304
MERCEDES	A9754200401	EFR6305	MERCEDES	A9754206701	EFR6305
MERCEDES	A9754200501	EFR6304	MERCEDES	A9754206801	EFR6304
MERCEDES	A9754200701	EFR6306	MERCEDES	A9754207001	EFR6306
MERCEDES	A9754200801	EFR6307	MERCEDES	A9754207101	EFR6307
MERCEDES	A9754200901	EFR6305	MERCEDES	A9754207201	EFR6306
MERCEDES	A9754201001	EFR6304	MERCEDES	A9754207301	EFR6307
MERCEDES	A9754201101	EFR6306	MERCEDES	A9754207401	EFR6305
MERCEDES	A9754201201	EFR6307	MERCEDES	A9754207501	EFR6304
MERCEDES	A9754201301	EFR6305	MERCEDES	A9754207601	EFR6305
MERCEDES	A9754201401	EFR6304	MERCEDES	A9754207701	EFR6304
MERCEDES	A9754201501	EFR6306	MERCEDES	A9754210012	09.8573.10
MERCEDES	A9754201601	EFR6307	MERCEDES	A9754210012	93101400
MERCEDES	A9754201801	EFR6305	MERCEDES	A9754210012	FCR189A
MERCEDES	A9754201901	EFR6304	MERCEDES	A9754210112	09.8573.10
MERCEDES	A9754202001	EFR6305	MERCEDES	A9754210112	93101400
MERCEDES	A9754202101	EFR6304	MERCEDES	A9754210112	FCR189A
MERCEDES	A9754202201	EFR6305	MERCEDES	A9754210212	09.8573.10
MERCEDES	A9754202301	EFR6304	MERCEDES	A9754210212	93101400
MERCEDES	A9754202401	EFR6305	MERCEDES	A9754210212	FCR189A
MERCEDES	A9754202501	EFR6304	MERCEDES	A9754210512	09.8573.10
MERCEDES	A9754202601	EFR6301	MERCEDES	A9754210512	93101400
MERCEDES	A9754202701	EFR6300	MERCEDES	A9754210512	FCR189A
MERCEDES	A9754202801	EFR6301	MERCEDES	A9754230012	09.8925.10
MERCEDES	A9754202901	EFR6300	MERCEDES	A9754230012	93101500

Les correspondances de références ont pour seul objectif d'aider la recherche de référence

Cross references are there for the sole purpose of helping the reference search

CORRESPONDANCES DES REFERENCES CROSS REFERENCE LIST

MARQUE/MAKER	REF/PN OES	REF/PN	MARQUE/MAKER	REF/PN OES	REF/PN
MERCEDES	A9754230012	FCR190A	MERITOR	68032175NFX	EFR7605
MERCEDES	A9754230312	09.8925.10	MERITOR	68032176	EFR7608
MERCEDES	A9754230312	93101500	MERITOR	68032176NFX	EFR7608
MERCEDES	A9754230312	FCR190A	MERITOR	68032177	EFR7609
MERCEDES	A9754230612	09.8925.10	MERITOR	68032177NFX	EFR7609
MERCEDES	A9754230612	93101500	MERITOR	68032196	EFR7606
MERCEDES	A9754230612	FCR190A	MERITOR	68032197	EFR7607
MERCEDES	A9794200101	EFR5302	MERITOR	68032216	EFR7606
MERCEDES	A9794200201	EFR5303	MERITOR	68032217	EFR7607
MERITOR	15224836	EFR6650	MERITOR	68032248	EFR7606
MERITOR	15224836SR	EFR6650	MERITOR	68032248NFX	EFR7606
MERITOR	15224837	EFR6651	MERITOR	68032249	EFR7607
MERITOR	15224837SR	EFR6651	MERITOR	68032249NFX	EFR7607
MERITOR	15227419T	2913103	MERITOR	68032250	EFR7606
MERITOR	15227419T	2913115	MERITOR	68032250NGZ	EFR7606
MERITOR	15227419T	CVP088K	MERITOR	68032251	EFR7607
MERITOR	1SU212K	98034500	MERITOR	68032251NGZ	EFR7607
MERITOR	21224263	FCR248A	MERITOR	68032252	EFR7606
MERITOR	31932102	EFR7632	MERITOR	68032252NGZ	EFR7606
MERITOR	31932103	EFR7633	MERITOR	68032253	EFR7607
MERITOR	3218F1514	09.B750.10	MERITOR	68032253NGZ	EFR7607
MERITOR	3218G1333	09.7957.10	MERITOR	68032254	EFR7606
MERITOR	3218G1333	93117700	MERITOR	68032254NGZ	EFR7606
MERITOR	3218H1308	93127900	MERITOR	68032255	EFR7607
MERITOR	3218H1308	FCR248A	MERITOR	68032255NGZ	EFR7607
MERITOR	3222X2156	2912405	MERITOR	68032279	EFR7644
MERITOR	3222X2156	CVP024K	MERITOR	68032310	EFR7610
MERITOR	68032046	EFR7652	MERITOR	68032310NFE	EFR7610
MERITOR	68032046NFE	EFR7652	MERITOR	68032311	EFR7611
MERITOR	68032047	EFR7653	MERITOR	68032311NFE	EFR7611
MERITOR	68032047NFE	EFR7653	MERITOR	68032312	EFR7612
MERITOR	68032144	EFR7600	MERITOR	68032312NFE	EFR7612
MERITOR	68032144NGS	EFR7600	MERITOR	68032313	EFR7613
MERITOR	68032145	EFR7601	MERITOR	68032313NFE	EFR7613
MERITOR	68032145NGS	EFR7601	MERITOR	68032326	EFR7600
MERITOR	68032146	EFR7602	MERITOR	68032326NGS	EFR7600
MERITOR	68032146NFE	EFR7602	MERITOR	68032327	EFR7601
MERITOR	68032147	EFR7603	MERITOR	68032327NGS	EFR7601
MERITOR	68032147NFE	EFR7603	MERITOR	68032332	EFR7606
MERITOR	68032170	EFR7606	MERITOR	68032333	EFR7607
MERITOR	68032170NFX	EFR7606	MERITOR	68032334	EFR6654
MERITOR	68032171	EFR7607	MERITOR	68032334NST	EFR6654
MERITOR	68032171NFX	EFR7607	MERITOR	68032335	EFR6655
MERITOR	68032172	EFR7710	MERITOR	68032335NST	EFR6655
MERITOR	68032173	EFR7711	MERITOR	68032338	EFR7606
MERITOR	68032174	EFR7604	MERITOR	68032338NQP	EFR7606
MERITOR	68032174NFX	EFR7604	MERITOR	68032339	EFR7607
MERITOR	68032175	EFR7605	MERITOR	68032339NQP	EFR7607

Les correspondances de références ont pour seul objectif d'aider la recherche de référence

Cross references are there for the sole purpose of helping the reference search

CORRESPONDANCES DES REFERENCES CROSS REFERENCE LIST

MARQUE/MAKER	REF/PN OES	REF/PN	MARQUE/MAKER	REF/PN OES	REF/PN
MERITOR	68032340	EFR7612	MERITOR	68032502	EFR7625
MERITOR	68032341	EFR7613	MERITOR	68032502NUH	EFR7625
MERITOR	68032346	EFR7600	MERITOR	68032521	EFR7634
MERITOR	68032346NRG	EFR7600	MERITOR	68032522	EFR7635
MERITOR	68032347	EFR7601	MERITOR	68032523	EFR7632
MERITOR	68032347NRG	EFR7601	MERITOR	68032523NRG	EFR7632
MERITOR	68032348	EFR7600	MERITOR	68032524	EFR7633
MERITOR	68032349	EFR7601	MERITOR	68032524NRG	EFR7633
MERITOR	68032354	EFR6654	MERITOR	68032525	EFR7636
MERITOR	68032354NFE	EFR6654	MERITOR	68032525NRG	EFR7636
MERITOR	68032354NWI	EFR6654	MERITOR	68032526	EFR7637
MERITOR	68032355	EFR6655	MERITOR	68032526NRG	EFR7637
MERITOR	68032355NFE	EFR6655	MERITOR	68032527	EFR7646
MERITOR	68032355NWI	EFR6655	MERITOR	68032528	EFR7647
MERITOR	68032358	EFR7632	MERITOR	68032529	EFR7632
MERITOR	68032358NRG	EFR7632	MERITOR	68032529NZF	EFR7632
MERITOR	68032359	EFR7633	MERITOR	68032530	EFR7633
MERITOR	68032359NRG	EFR7633	MERITOR	68032530NZF	EFR7633
MERITOR	68032377	EFR7610	MERITOR	68032531	EFR7646
MERITOR	68032377NSQ	EFR7610	MERITOR	68032532	EFR7647
MERITOR	68032378	EFR7611	MERITOR	68032533	EFR7636
MERITOR	68032378NSQ	EFR7611	MERITOR	68032533NZF	EFR7636
MERITOR	68032381	EFR6654	MERITOR	68032534	EFR7637
MERITOR	68032382	EFR6655	MERITOR	68032534NZF	EFR7637
MERITOR	68032385	EFR7652	MERITOR	68032543	EFR7612
MERITOR	68032386	EFR7653	MERITOR	68032543NFE	EFR7612
MERITOR	68032391	EFR7602	MERITOR	68032544	EFR7613
MERITOR	68032391NFE	EFR7602	MERITOR	68032544NFE	EFR7613
MERITOR	68032392	EFR7603	MERITOR	68032555	EFR7632
MERITOR	68032392NFE	EFR7603	MERITOR	68032556	EFR7633
MERITOR	68032397	EFR7606	MERITOR	68032565	EFR7604
MERITOR	68032397NGZ	EFR7606	MERITOR	68032566	EFR7605
MERITOR	68032398	EFR7607	MERITOR	68032567	EFR7608
MERITOR	68032398NGZ	EFR7607	MERITOR	68032568	EFR7609
MERITOR	68032409	EFR7622	MERITOR	68032578	EFR7646
MERITOR	68032409NUH	EFR7622	MERITOR	68032578NZF	EFR7646
MERITOR	68032410	EFR7623	MERITOR	68032579	EFR7647
MERITOR	68032410NUH	EFR7623	MERITOR	68032579NZF	EFR7647
MERITOR	68032411	EFR7630	MERITOR	68032580	EFR7624
MERITOR	68032411NUH	EFR7630	MERITOR	68032581	EFR7625
MERITOR	68032412	EFR7631	MERITOR	68032582	EFR7630
MERITOR	68032412NUH	EFR7631	MERITOR	68032583	EFR7631
MERITOR	68032413	EFR7636	MERITOR	68032584	EFR7622
MERITOR	68032413NRG	EFR7636	MERITOR	68032585	EFR7623
MERITOR	68032414	EFR7637	MERITOR	68032588	EFR7656
MERITOR	68032414NRG	EFR7637	MERITOR	68032588NZP	EFR7656
MERITOR	68032501	EFR7624	MERITOR	68032589	EFR7657
MERITOR	68032501NUH	EFR7624	MERITOR	68032589NZP	EFR7657

Les correspondances de références ont pour seul objectif d'aider la recherche de référence

Cross references are there for the sole purpose of helping the reference search

CORRESPONDANCES DES REFERENCES CROSS REFERENCE LIST

MARQUE/MAKER	REF/PN OES	REF/PN	MARQUE/MAKER	REF/PN OES	REF/PN
MERITOR	68032596	EFR7640	MERITOR	68032667	EFR7601
MERITOR	68032596NZF	EFR7640	MERITOR	68032667NGS	EFR7601
MERITOR	68032597	EFR7641	MERITOR	68032670	EFR7696
MERITOR	68032597NZF	EFR7641	MERITOR	68032670NZF	EFR7696
MERITOR	68032617	EFR7638	MERITOR	68032671	EFR7697
MERITOR	68032617NZP	EFR7638	MERITOR	68032671NZF	EFR7697
MERITOR	68032618	EFR7639	MERITOR	68032675	EFR7606
MERITOR	68032618NZP	EFR7639	MERITOR	68032675NGZ	EFR7606
MERITOR	68032619	EFR7638	MERITOR	68032676	EFR7607
MERITOR	68032620	EFR7639	MERITOR	68032676NGZ	EFR7607
MERITOR	68032621	EFR7634	MERITOR	68032679	EFR7606
MERITOR	68032621NZF	EFR7634	MERITOR	68032679NGZ	EFR7606
MERITOR	68032622	EFR7635	MERITOR	68032680	EFR7607
MERITOR	68032622NZF	EFR7635	MERITOR	68032680NGZ	EFR7607
MERITOR	68032624	EFR7642	MERITOR	68032683	EFR7610
MERITOR	68032624NRG	EFR7642	MERITOR	68032683NZP	EFR7610
MERITOR	68032625	EFR7643	MERITOR	68032684	EFR7611
MERITOR	68032625NRG	EFR7643	MERITOR	68032684NZP	EFR7611
MERITOR	68032628	EFR7612	MERITOR	68032695	EFR7636
MERITOR	68032629	EFR7613	MERITOR	68032696	EFR7637
MERITOR	68032632	EFR7610	MERITOR	68032722	EFR7636
MERITOR	68032633	EFR7611	MERITOR	68032722NZF	EFR7636
MERITOR	68032640	EFR7632	MERITOR	68032723	EFR7637
MERITOR	68032641	EFR7633	MERITOR	68032723NZF	EFR7637
MERITOR	68032644	EFR7694	MERITOR	68032724	EFR7632
MERITOR	68032645	EFR7695	MERITOR	68032724NZF	EFR7632
MERITOR	68032652	EFR7646	MERITOR	68032725	EFR7633
MERITOR	68032652NZF	EFR7646	MERITOR	68032725NZF	EFR7633
MERITOR	68032653	EFR7647	MERITOR	68032726	EFR7646
MERITOR	68032653NZF	EFR7647	MERITOR	68032726NZF	EFR7646
MERITOR	68032656	EFR7632	MERITOR	68032727	EFR7647
MERITOR	68032657	EFR7633	MERITOR	68032727NZF	EFR7647
MERITOR	68032658	EFR7636	MERITOR	68032741	EFR7638
MERITOR	68032659	EFR7637	MERITOR	68032741NZF	EFR7638
MERITOR	68032660	EFR7636	MERITOR	68032742	EFR7639
MERITOR	68032660NZF	EFR7636	MERITOR	68032742NZF	EFR7639
MERITOR	68032661	EFR7637	MERITOR	68032755	EFR7658
MERITOR	68032661NZF	EFR7637	MERITOR	68032755NZP	EFR7658
MERITOR	68032662	EFR7600	MERITOR	68032756	EFR7659
MERITOR	68032662NZF	EFR7600	MERITOR	68032756NZP	EFR7659
MERITOR	68032663	EFR7601	MERITOR	68032757	EFR7658
MERITOR	68032663NZF	EFR7601	MERITOR	68032757NZP	EFR7658
MERITOR	68032664	EFR7600	MERITOR	68032758	EFR7659
MERITOR	68032664NZF	EFR7600	MERITOR	68032758NZP	EFR7659
MERITOR	68032665	EFR7601	MERITOR	68032763	EFR7658
MERITOR	68032665NZF	EFR7601	MERITOR	68032763NZP	EFR7658
MERITOR	68032666	EFR7600	MERITOR	68032764	EFR7659
MERITOR	68032666NGS	EFR7600	MERITOR	68032764NZP	EFR7659

Les correspondances de références ont pour seul objectif d'aider la recherche de référence

Cross references are there for the sole purpose of helping the reference search

CORRESPONDANCES DES REFERENCES CROSS REFERENCE LIST

MARQUE/MAKER	REF/PN OES	REF/PN	MARQUE/MAKER	REF/PN OES	REF/PN
MERITOR	68032765	EFR7658	MERITOR	68032816	EFR7640
MERITOR	68032765NZP	EFR7658	MERITOR	68032816NZF	EFR7640
MERITOR	68032766	EFR7659	MERITOR	68032817	EFR7641
MERITOR	68032766NZP	EFR7659	MERITOR	68032817NZF	EFR7641
MERITOR	68032767	EFR7660	MERITOR	68032820	EFR7634
MERITOR	68032767NZP	EFR7660	MERITOR	68032821	EFR7635
MERITOR	68032768	EFR7661	MERITOR	68032822	EFR7642
MERITOR	68032768NZP	EFR7661	MERITOR	68032823	EFR7643
MERITOR	68032771	EFR7660	MERITOR	68032824	EFR7640
MERITOR	68032771NZP	EFR7660	MERITOR	68032825	EFR7641
MERITOR	68032772	EFR7661	MERITOR	68032826	EFR7648
MERITOR	68032772NZP	EFR7661	MERITOR	68032827	EFR7649
MERITOR	68032776	EFR7634	MERITOR	68032828	EFR7636
MERITOR	68032776NZF	EFR7634	MERITOR	68032829	EFR7637
MERITOR	68032777	EFR7635	MERITOR	68032830	EFR7644
MERITOR	68032777NZF	EFR7635	MERITOR	68032831	EFR7645
MERITOR	68032778	EFR7696	MERITOR	68032832	EFR7612
MERITOR	68032779	EFR7697	MERITOR	68032832NFE	EFR7612
MERITOR	68032780	EFR7648	MERITOR	68032833	EFR7613
MERITOR	68032780NZF	EFR7648	MERITOR	68032833NFE	EFR7613
MERITOR	68032781	EFR7649	MERITOR	68032835	EFR7638
MERITOR	68032781NZF	EFR7649	MERITOR	68032836	EFR7639
MERITOR	68032788	EFR7644	MERITOR	68032845	EFR7658
MERITOR	68032788NZF	EFR7644	MERITOR	68032846	EFR7659
MERITOR	68032789	EFR7645	MERITOR	68032847	EFR7658
MERITOR	68032789NZF	EFR7645	MERITOR	68032847NZP	EFR7658
MERITOR	68032790	EFR7636	MERITOR	68032848	EFR7659
MERITOR	68032790NZF	EFR7636	MERITOR	68032848NZP	EFR7659
MERITOR	68032791	EFR7637	MERITOR	68032856	EFR7632
MERITOR	68032791NZF	EFR7637	MERITOR	68032857	EFR7633
MERITOR	68032792	EFR7632	MERITOR	68032858	EFR7630
MERITOR	68032793	EFR7633	MERITOR	68032859	EFR7631
MERITOR	68032794	EFR7646	MERITOR	68032860	EFR7622
MERITOR	68032795	EFR7647	MERITOR	68032861	EFR7623
MERITOR	68032796	EFR7636	MERITOR	68032862	EFR7624
MERITOR	68032797	EFR7637	MERITOR	68032863	EFR7625
MERITOR	68032802	EFR7716	MERITOR	68032864	EFR7614
MERITOR	68032802NZF	EFR7716	MERITOR	68032865	EFR7615
MERITOR	68032803	EFR7717	MERITOR	68032866	EFR7614
MERITOR	68032803NZF	EFR7717	MERITOR	68032867	EFR7615
MERITOR	68032804	EFR7694	MERITOR	68032883	EFR7614
MERITOR	68032804NZF	EFR7694	MERITOR	68032884	EFR7615
MERITOR	68032805	EFR7695	MERITOR	68032901	EFR7658
MERITOR	68032805NZF	EFR7695	MERITOR	68032901NZP	EFR7658
MERITOR	68032814	EFR7642	MERITOR	68032902	EFR7659
MERITOR	68032814NZF	EFR7642	MERITOR	68032902NZP	EFR7659
MERITOR	68032815	EFR7643	MERITOR	68032903	EFR7658
MERITOR	68032815NZF	EFR7643	MERITOR	68032903NZP	EFR7658

Les correspondances de références ont pour seul objectif d'aider la recherche de référence

Cross references are there for the sole purpose of helping the reference search

CORRESPONDANCES DES REFERENCES CROSS REFERENCE LIST

MARQUE/MAKER	REF/PN OES	REF/PN	MARQUE/MAKER	REF/PN OES	REF/PN
MERITOR	68032904	EFR7659	MERITOR	68032977	EFR7675
MERITOR	68032904NZZ	EFR7659	MERITOR	68032977NZZ	EFR7675
MERITOR	68032905	EFR7658	MERITOR	68032978	EFR7666
MERITOR	68032905NZZ	EFR7658	MERITOR	68032979	EFR7667
MERITOR	68032906	EFR7659	MERITOR	68032982	EFR7716
MERITOR	68032906NZZ	EFR7659	MERITOR	68032983	EFR7717
MERITOR	68032907	EFR7660	MERITOR	68032984	EFR7694
MERITOR	68032907NZZ	EFR7660	MERITOR	68032985	EFR7695
MERITOR	68032908	EFR7661	MERITOR	68032988	EFR7618
MERITOR	68032908NZZ	EFR7661	MERITOR	68032989	EFR7619
MERITOR	68032909	EFR7658	MERITOR	68032990	EFR6626
MERITOR	68032909NZZ	EFR7658	MERITOR	68032991	EFR6627
MERITOR	68032910	EFR7659	MERITOR	68032992	EFR6620
MERITOR	68032910NZZ	EFR7659	MERITOR	68032993	EFR6621
MERITOR	68032911	EFR7658	MERITOR	68032994	EFR7630
MERITOR	68032911NZZ	EFR7658	MERITOR	68032995	EFR7631
MERITOR	68032912	EFR7659	MERITOR	68032996	EFR7622
MERITOR	68032912NZZ	EFR7659	MERITOR	68032997	EFR7623
MERITOR	68032913	EFR7658	MERITOR	68032998	EFR7624
MERITOR	68032913NZZ	EFR7658	MERITOR	68032999	EFR7625
MERITOR	68032914	EFR7659	MERITOR	68033001	EFR7618
MERITOR	68032914NZZ	EFR7659	MERITOR	68033002	EFR7619
MERITOR	68032915	EFR7660	MERITOR	68033003	EFR7618
MERITOR	68032915NZZ	EFR7660	MERITOR	68033004	EFR7619
MERITOR	68032916	EFR7661	MERITOR	68033005	EFR7618
MERITOR	68032916NZZ	EFR7661	MERITOR	68033006	EFR7619
MERITOR	68032917	EFR7614	MERITOR	68033007	EFR6626
MERITOR	68032918	EFR7615	MERITOR	68033008	EFR6627
MERITOR	68032919	EFR7614	MERITOR	68033009	EFR6626
MERITOR	68032919NZZ	EFR7614	MERITOR	68033010	EFR6627
MERITOR	68032920	EFR7615	MERITOR	68033017	EFR6627
MERITOR	68032920NZZ	EFR7615	MERITOR	68033018	EFR6626
MERITOR	68032921	EFR7612	MERITOR	68033021	EFR7622
MERITOR	68032921NFE	EFR7612	MERITOR	68033022	EFR7623
MERITOR	68032922	EFR7613	MERITOR	68033025	EFR7612
MERITOR	68032922NFE	EFR7613	MERITOR	68033026	EFR7613
MERITOR	68032944	EFR7696	MERITOR	68033035	EFR7710
MERITOR	68032944NZZ	EFR7696	MERITOR	68033036	EFR7711
MERITOR	68032945	EFR7697	MERITOR	68033040	EFR7602
MERITOR	68032945NZZ	EFR7697	MERITOR	68033041	EFR7603
MERITOR	68032959	EFR7630	MERITOR	68033042	EFR7612
MERITOR	68032960	EFR7631	MERITOR	68033043	EFR7613
MERITOR	68032961	EFR7612	MERITOR	68033044	EFR7658
MERITOR	68032961NFE	EFR7612	MERITOR	68033045	EFR7659
MERITOR	68032962	EFR7613	MERITOR	68033046	EFR7660
MERITOR	68032962NFE	EFR7613	MERITOR	68033047	EFR7661
MERITOR	68032976	EFR7674	MERITOR	68033048	EFR7630
MERITOR	68032976NZZ	EFR7674	MERITOR	68033049	EFR7631

Les correspondances de références ont pour seul objectif d'aider la recherche de référence

Cross references are there for the sole purpose of helping the reference search

CORRESPONDANCES DES REFERENCES CROSS REFERENCE LIST

MARQUE/MAKER	REF/PN OES	REF/PN	MARQUE/MAKER	REF/PN OES	REF/PN
MERITOR	68033050	EFR7606	MERITOR	68033099	EFR6627
MERITOR	68033051	EFR7607	MERITOR	68033100	EFR6626
MERITOR	68033052	EFR7606	MERITOR	68033103	EFR7630
MERITOR	68033053	EFR7607	MERITOR	68033104	EFR7631
MERITOR	68033060	EFR7610	MERITOR	68033109	EFR6620
MERITOR	68033061	EFR7611	MERITOR	68033110	EFR6621
MERITOR	68033065	EFR7660	MERITOR	68033114	EFR7624
MERITOR	68033065NZZ	EFR7660	MERITOR	68033115	EFR7625
MERITOR	68033066	EFR7661	MERITOR	68033116	EFR7630
MERITOR	68033066NZZ	EFR7661	MERITOR	68033117	EFR7631
MERITOR	68033067	EFR7660	MERITOR	68033118	EFR7630
MERITOR	68033067NZZ	EFR7660	MERITOR	68033119	EFR7631
MERITOR	68033068	EFR7661	MERITOR	68033120	EFR7622
MERITOR	68033068NZZ	EFR7661	MERITOR	68033121	EFR7623
MERITOR	68033069	EFR7612	MERITOR	68033122	EFR7624
MERITOR	68033069M01	EFR7612	MERITOR	68033123	EFR7625
MERITOR	68033070	EFR7613	MERITOR	68033140	EFR7640
MERITOR	68033070M01	EFR7613	MERITOR	68033140M07	EFR7640
MERITOR	68033071	EFR7612	MERITOR	68033141	EFR7641
MERITOR	68033071M02	EFR7612	MERITOR	68033141M07	EFR7641
MERITOR	68033072	EFR7613	MERITOR	68033142	EFR7642
MERITOR	68033072M02	EFR7613	MERITOR	68033142M07	EFR7642
MERITOR	68033073	EFR7630	MERITOR	68033143	EFR7643
MERITOR	68033074	EFR7631	MERITOR	68033143M07	EFR7643
MERITOR	68033075	EFR7622	MERITOR	68033144	EFR7636
MERITOR	68033076	EFR7623	MERITOR	68033144M07	EFR7636
MERITOR	68033077	EFR7624	MERITOR	68033145	EFR7637
MERITOR	68033078	EFR7625	MERITOR	68033145M07	EFR7637
MERITOR	68033083	EFR7610	MERITOR	68033146	EFR7644
MERITOR	68033083NZZ	EFR7610	MERITOR	68033146M07	EFR7644
MERITOR	68033084	EFR7611	MERITOR	68033147	EFR7645
MERITOR	68033084NZZ	EFR7611	MERITOR	68033147M07	EFR7645
MERITOR	68033085	EFR6654	MERITOR	68033148	EFR7632
MERITOR	68033086	EFR6655	MERITOR	68033148NZZ	EFR7632
MERITOR	68033087	EFR7716	MERITOR	68033149	EFR7633
MERITOR	68033087NZZ	EFR7716	MERITOR	68033149NZZ	EFR7633
MERITOR	68033088	EFR7717	MERITOR	68033150	EFR7648
MERITOR	68033088NZZ	EFR7717	MERITOR	68033150NZZ	EFR7648
MERITOR	68033089	EFR7694	MERITOR	68033151	EFR7649
MERITOR	68033089NZZ	EFR7694	MERITOR	68033151NZZ	EFR7649
MERITOR	68033090	EFR7695	MERITOR	68033158	EFR7618
MERITOR	68033090NZZ	EFR7695	MERITOR	68033159	EFR7619
MERITOR	68033091	EFR7716	MERITOR	68033160	EFR7618
MERITOR	68033092	EFR7717	MERITOR	68033161	EFR7619
MERITOR	68033093	EFR7694	MERITOR	68033162	EFR7618
MERITOR	68033094	EFR7695	MERITOR	68033163	EFR7619
MERITOR	68033097	EFR6627	MERITOR	68033166	EFR7668
MERITOR	68033098	EFR6626	MERITOR	68033166NZZ	EFR7668

Les correspondances de références ont pour seul objectif d'aider la recherche de référence

Cross references are there for the sole purpose of helping the reference search

CORRESPONDANCES DES REFERENCES CROSS REFERENCE LIST

MARQUE/MAKER	REF/PN OES	REF/PN	MARQUE/MAKER	REF/PN OES	REF/PN
MERITOR	68033167	EFR7669	MERITOR	68033210	EFR7694
MERITOR	68033167NZP	EFR7669	MERITOR	68033210NZF	EFR7694
MERITOR	68033168	EFR7668	MERITOR	68033211	EFR7695
MERITOR	68033168NZP	EFR7668	MERITOR	68033211NZF	EFR7695
MERITOR	68033169	EFR7669	MERITOR	68033214	EFR6620
MERITOR	68033169NZP	EFR7669	MERITOR	68033215	EFR6621
MERITOR	68033170	EFR7668	MERITOR	68033216	EFR6621
MERITOR	68033171	EFR7669	MERITOR	68033217	EFR6620
MERITOR	68033172	EFR7662	MERITOR	68033218	EFR6620
MERITOR	68033173	EFR7663	MERITOR	68033219	EFR6621
MERITOR	68033174	EFR7662	MERITOR	68033220	EFR6620
MERITOR	68033174NZP	EFR7662	MERITOR	68033221	EFR6621
MERITOR	68033175	EFR7663	MERITOR	68033228	EFR6621
MERITOR	68033175NZP	EFR7663	MERITOR	68033229	EFR6620
MERITOR	68033176	EFR7668	MERITOR	68033231	EFR7634
MERITOR	68033176NZP	EFR7668	MERITOR	68033231NZF	EFR7634
MERITOR	68033177	EFR7669	MERITOR	68033232	EFR7635
MERITOR	68033177NZP	EFR7669	MERITOR	68033232NZF	EFR7635
MERITOR	68033178	EFR7668	MERITOR	68033233	EFR7628
MERITOR	68033178NZP	EFR7668	MERITOR	68033234	EFR7629
MERITOR	68033179	EFR7669	MERITOR	68033247	EFR7674
MERITOR	68033179NZP	EFR7669	MERITOR	68033248	EFR7675
MERITOR	68033180	EFR7668	MERITOR	68033249	EFR7666
MERITOR	68033181	EFR7669	MERITOR	68033250	EFR7667
MERITOR	68033182	EFR7668	MERITOR	68033252	EFR7672
MERITOR	68033182NZP	EFR7668	MERITOR	68033253	EFR7673
MERITOR	68033183	EFR7669	MERITOR	68033254	EFR7664
MERITOR	68033183NZP	EFR7669	MERITOR	68033255	EFR7665
MERITOR	68033184	EFR7662	MERITOR	68033272	EFR7640
MERITOR	68033184NZP	EFR7662	MERITOR	68033272NZF	EFR7640
MERITOR	68033185	EFR7663	MERITOR	68033273	EFR7641
MERITOR	68033185NZP	EFR7663	MERITOR	68033273NZF	EFR7641
MERITOR	68033186	EFR7662	MERITOR	68033274	EFR7642
MERITOR	68033186NZP	EFR7662	MERITOR	68033274NZF	EFR7642
MERITOR	68033187	EFR7663	MERITOR	68033275	EFR7643
MERITOR	68033187NZP	EFR7663	MERITOR	68033275NZF	EFR7643
MERITOR	68033188	EFR7662	MERITOR	68033276	EFR7636
MERITOR	68033189	EFR7663	MERITOR	68033276NZF	EFR7636
MERITOR	68033190	EFR7672	MERITOR	68033277	EFR7637
MERITOR	68033190NZP	EFR7672	MERITOR	68033277NZF	EFR7637
MERITOR	68033191	EFR7673	MERITOR	68033278	EFR7644
MERITOR	68033191NZP	EFR7673	MERITOR	68033278NZF	EFR7644
MERITOR	68033192	EFR7664	MERITOR	68033279	EFR7645
MERITOR	68033193	EFR7665	MERITOR	68033279NZF	EFR7645
MERITOR	68033206	EFR7716	MERITOR	68033280	EFR7716
MERITOR	68033206NZF	EFR7716	MERITOR	68033280NZF	EFR7716
MERITOR	68033207	EFR7717	MERITOR	68033281	EFR7717
MERITOR	68033207NZF	EFR7717	MERITOR	68033281NZF	EFR7717

Les correspondances de références ont pour seul objectif d'aider la recherche de référence

Cross references are there for the sole purpose of helping the reference search

CORRESPONDANCES DES REFERENCES CROSS REFERENCE LIST

MARQUE/MAKER	REF/PN OES	REF/PN	MARQUE/MAKER	REF/PN OES	REF/PN
MERITOR	68033282	EFR7694	MERITOR	68033353	EFR7692
MERITOR	68033282NZF	EFR7694	MERITOR	68033353NZP	EFR7692
MERITOR	68033283	EFR7695	MERITOR	68033354	EFR7693
MERITOR	68033283NZF	EFR7695	MERITOR	68033354NZP	EFR7693
MERITOR	68033288	EFR7716	MERITOR	68033359	EFR6603
MERITOR	68033289	EFR7717	MERITOR	68033360	EFR6602
MERITOR	68033290	EFR7694	MERITOR	68033361	EFR7692
MERITOR	68033291	EFR7695	MERITOR	68033362	EFR7693
MERITOR	68033297	EFR7638	MERITOR	68033363	EFR7696
MERITOR	68033297M07	EFR7638	MERITOR	68033364	EFR7697
MERITOR	68033298	EFR7639	MERITOR	68033374	EFR7668
MERITOR	68033298M07	EFR7639	MERITOR	68033374NZP	EFR7668
MERITOR	68033299	EFR7632	MERITOR	68033375	EFR7669
MERITOR	68033299NZF	EFR7632	MERITOR	68033375NZP	EFR7669
MERITOR	68033300	EFR7633	MERITOR	68033377	EFR7638
MERITOR	68033300NZF	EFR7633	MERITOR	68033377NZP	EFR7638
MERITOR	68033301	EFR7648	MERITOR	68033378	EFR7639
MERITOR	68033301NZF	EFR7648	MERITOR	68033378NZP	EFR7639
MERITOR	68033302	EFR7649	MERITOR	68033379	EFR7700
MERITOR	68033302NZF	EFR7649	MERITOR	68033380	EFR7701
MERITOR	68033303	EFR7600	MERITOR	68033381	EFR7678
MERITOR	68033303NZF	EFR7600	MERITOR	68033382	EFR7679
MERITOR	68033304	EFR7601	MERITOR	68033383	EFR7676
MERITOR	68033304NZF	EFR7601	MERITOR	68033384	EFR7677
MERITOR	68033312	EFR7614	MERITOR	68033395	EFR7612
MERITOR	68033312NZP	EFR7614	MERITOR	68033395M01	EFR7612
MERITOR	68033313	EFR7615	MERITOR	68033396	EFR7613
MERITOR	68033313NZP	EFR7615	MERITOR	68033396M01	EFR7613
MERITOR	68033314	EFR7614	MERITOR	68033397	EFR7612
MERITOR	68033314NZP	EFR7614	MERITOR	68033398	EFR7613
MERITOR	68033315	EFR7615	MERITOR	68033405	EFR7642
MERITOR	68033315NZP	EFR7615	MERITOR	68033405M07	EFR7642
MERITOR	68033316	EFR7614	MERITOR	68033406	EFR7643
MERITOR	68033316NZP	EFR7614	MERITOR	68033406M07	EFR7643
MERITOR	68033317	EFR7615	MERITOR	68033407	EFR7640
MERITOR	68033317NZP	EFR7615	MERITOR	68033407M07	EFR7640
MERITOR	68033331	EFR7616	MERITOR	68033408	EFR7641
MERITOR	68033332	EFR7617	MERITOR	68033408M07	EFR7641
MERITOR	68033335	EFR6654	MERITOR	68033409	EFR7642
MERITOR	68033335NZP	EFR6654	MERITOR	68033409NZF	EFR7642
MERITOR	68033336	EFR6655	MERITOR	68033410	EFR7643
MERITOR	68033336NZP	EFR6655	MERITOR	68033410NZF	EFR7643
MERITOR	68033337	EFR6621	MERITOR	68033411	EFR7640
MERITOR	68033338	EFR6621	MERITOR	68033411NZF	EFR7640
MERITOR	68033347	EFR7694	MERITOR	68033412	EFR7641
MERITOR	68033347M04	EFR7694	MERITOR	68033412NZF	EFR7641
MERITOR	68033348	EFR7695	MERITOR	68033413	EFR7698
MERITOR	68033348M04	EFR7695	MERITOR	68033414	EFR7699

Les correspondances de références ont pour seul objectif d'aider la recherche de référence

Cross references are there for the sole purpose of helping the reference search

CORRESPONDANCES DES REFERENCES CROSS REFERENCE LIST

MARQUE/MAKER	REF/PN OES	REF/PN	MARQUE/MAKER	REF/PN OES	REF/PN
MERITOR	68033415	EFR7684	MERITOR	68033534	EFR7679
MERITOR	68033415NZZ	EFR7684	MERITOR	68033535	EFR7676
MERITOR	68033416	EFR7685	MERITOR	68033536	EFR7677
MERITOR	68033416NZZ	EFR7685	MERITOR	68033541	EFR6656
MERITOR	68033417	EFR7684	MERITOR	68033542	EFR6657
MERITOR	68033418	EFR7685	MERITOR	68033546	EFR6654
MERITOR	68033421	EFR7718	MERITOR	68033547	EFR6655
MERITOR	68033421	EFR7720	MERITOR	68033559	EFR7700
MERITOR	68033422	EFR7720	MERITOR	68033559M10	EFR7700
MERITOR	68033427	EFR7702	MERITOR	68033560	EFR7701
MERITOR	68033428	EFR7703	MERITOR	68033560M10	EFR7701
MERITOR	68033429	EFR7668	MERITOR	68033561	EFR7702
MERITOR	68033429NZZ	EFR7668	MERITOR	68033561M10	EFR7702
MERITOR	68033430	EFR7669	MERITOR	68033562	EFR7703
MERITOR	68033430NZZ	EFR7669	MERITOR	68033562M10	EFR7703
MERITOR	68033497	EFR6620	MERITOR	68033563	EFR7700
MERITOR	68033498	EFR6621	MERITOR	68033564	EFR7701
MERITOR	68033499	EFR7606	MERITOR	68033565	EFR7702
MERITOR	68033499M11	EFR7606	MERITOR	68033566	EFR7703
MERITOR	68033500	EFR7607	MERITOR	68033573	EFR7698
MERITOR	68033500M11	EFR7607	MERITOR	68033573M10	EFR7698
MERITOR	68033501	EFR7612	MERITOR	68033574	EFR7699
MERITOR	68033502	EFR7613	MERITOR	68033574M10	EFR7699
MERITOR	68033515	EFR7676R	MERITOR	68033575	EFR7698
MERITOR	68033515M16	EFR7676R	MERITOR	68033575M10	EFR7698
MERITOR	68033516	EFR7677R	MERITOR	68033576	EFR7699
MERITOR	68033516M16	EFR7677R	MERITOR	68033576M10	EFR7699
MERITOR	68033517	EFR7688	MERITOR	68033579	EFR7640
MERITOR	68033517M16	EFR7688	MERITOR	68033579M10	EFR7640
MERITOR	68033518	EFR7689	MERITOR	68033580	EFR7641
MERITOR	68033518M16	EFR7689	MERITOR	68033580M10	EFR7641
MERITOR	68033519	EFR7676R	MERITOR	68033581	EFR7646
MERITOR	68033519M17	EFR7676R	MERITOR	68033581M10	EFR7646
MERITOR	68033520	EFR7677R	MERITOR	68033582	EFR7647
MERITOR	68033520M17	EFR7677R	MERITOR	68033582M10	EFR7647
MERITOR	68033521	EFR7688	MERITOR	68033583	EFR7636
MERITOR	68033521M17	EFR7688	MERITOR	68033583M10	EFR7636
MERITOR	68033522	EFR7689	MERITOR	68033584	EFR7637
MERITOR	68033522M17	EFR7689	MERITOR	68033584M10	EFR7637
MERITOR	68033525	EFR7690	MERITOR	68033585	EFR7644
MERITOR	68033525M16	EFR7690	MERITOR	68033585M10	EFR7644
MERITOR	68033526	EFR7691	MERITOR	68033585M16	EFR7680
MERITOR	68033526M16	EFR7691	MERITOR	68033586	EFR7645
MERITOR	68033529	EFR7690	MERITOR	68033586M10	EFR7645
MERITOR	68033529M17	EFR7690	MERITOR	68033586M16	EFR7681
MERITOR	68033530	EFR7691	MERITOR	68033587	EFR7680
MERITOR	68033530M17	EFR7691	MERITOR	68033588	EFR7681
MERITOR	68033533	EFR7678	MERITOR	68033595	EFR7638

Les correspondances de références ont pour seul objectif d'aider la recherche de référence

Cross references are there for the sole purpose of helping the reference search

CORRESPONDANCES DES REFERENCES CROSS REFERENCE LIST

MARQUE/MAKER	REF/PN OES	REF/PN	MARQUE/MAKER	REF/PN OES	REF/PN
MERITOR	68033595M10	EFR7638	MERITOR	68033680M16	EFR7679
MERITOR	68033596	EFR7639	MERITOR	68033683	EFR7676
MERITOR	68033596M10	EFR7639	MERITOR	68033683M16	EFR7676
MERITOR	68033597	EFR7642	MERITOR	68033684	EFR7677
MERITOR	68033597M12	EFR7642	MERITOR	68033684M16	EFR7677
MERITOR	68033598	EFR7643	MERITOR	68033692	EFR7676
MERITOR	68033598M12	EFR7643	MERITOR	68033692M16	EFR7676
MERITOR	68033599	EFR7640	MERITOR	68033693	EFR7677
MERITOR	68033599M12	EFR7640	MERITOR	68033693M16	EFR7677
MERITOR	68033600	EFR7641	MERITOR	68033694	EFR7672
MERITOR	68033600M12	EFR7641	MERITOR	68033694NZZ	EFR7672
MERITOR	68033601	EFR6603	MERITOR	68033695	EFR7673
MERITOR	68033602	EFR6602	MERITOR	68033695NZZ	EFR7673
MERITOR	68033604	EFR7696	MERITOR	68033698	EFR7678
MERITOR	68033605	EFR7697	MERITOR	68033699	EFR7679
MERITOR	68033606	EFR7696	MERITOR	68033702	EFR7676
MERITOR	68033606M12	EFR7696	MERITOR	68033703	EFR7677
MERITOR	68033607	EFR7697	MERITOR	68033710	EFR7692
MERITOR	68033607M12	EFR7697	MERITOR	68033711	EFR7693
MERITOR	68033610	EFR7668	MERITOR	68033718	EFR7718
MERITOR	68033610NZZ	EFR7668	MERITOR	68033718	EFR7720
MERITOR	68033611	EFR7669	MERITOR	68033718M10	EFR7718
MERITOR	68033611NZZ	EFR7669	MERITOR	68033718M10	EFR7720
MERITOR	68033638	EFR7718	MERITOR	68033719	EFR7720
MERITOR	68033638	EFR7720	MERITOR	68033719M10	EFR7720
MERITOR	68033638M10	EFR7718	MERITOR	68033720	EFR7702
MERITOR	68033638M10	EFR7720	MERITOR	68033720M12	EFR7702
MERITOR	68033639	EFR7720	MERITOR	68033721	EFR7703
MERITOR	68033639M10	EFR7720	MERITOR	68033721M12	EFR7703
MERITOR	68033667	EFR7680	MERITOR	68033722	EFR7718
MERITOR	68033667M16	EFR7680	MERITOR	68033722M12	EFR7718
MERITOR	68033668	EFR7681	MERITOR	68033723	EFR7719
MERITOR	68033668M16	EFR7681	MERITOR	68033723M12	EFR7718
MERITOR	68033673	EFR7678	MERITOR	68033723M12	EFR7719
MERITOR	68033673M16	EFR7678	MERITOR	68033724	EFR7718
MERITOR	68033674	EFR7679	MERITOR	68033725	EFR7719
MERITOR	68033674M16	EFR7679	MERITOR	68033726	EFR7718
MERITOR	68033675	EFR7678	MERITOR	68033727	EFR7719
MERITOR	68033675M16	EFR7678	MERITOR	68033730	EFR7676
MERITOR	68033676	EFR7679	MERITOR	68033730M16	EFR7676
MERITOR	68033676M16	EFR7679	MERITOR	68033731	EFR7677
MERITOR	68033677	EFR7678	MERITOR	68033731M16	EFR7677
MERITOR	68033677M16	EFR7678	MERITOR	68033732	EFR7680
MERITOR	68033678	EFR7679	MERITOR	68033732M16	EFR7680
MERITOR	68033678M16	EFR7679	MERITOR	68033733	EFR7681
MERITOR	68033679	EFR7678	MERITOR	68033733M16	EFR7681
MERITOR	68033679M16	EFR7678	MERITOR	68033738	EFR7678
MERITOR	68033680	EFR7679	MERITOR	68033738M16	EFR7678

Les correspondances de références ont pour seul objectif d'aider la recherche de référence

Cross references are there for the sole purpose of helping the reference search

CORRESPONDANCES DES REFERENCES CROSS REFERENCE LIST

MARQUE/MAKER	REF/PN OES	REF/PN	MARQUE/MAKER	REF/PN OES	REF/PN
MERITOR	68033739	EFR7679	MERITOR	68033907	EFR7669
MERITOR	68033739M16	EFR7679	MERITOR	68033907NZP	EFR7669
MERITOR	68033740	EFR7678	MERITOR	68033908	EFR7692
MERITOR	68033740M16	EFR7678	MERITOR	68033909	EFR7693
MERITOR	68033741	EFR7679	MERITOR	68033910	EFR7692
MERITOR	68033741M16	EFR7679	MERITOR	68033911	EFR7693
MERITOR	68033743	EFR6600	MERITOR	68033912	EFR6656
MERITOR	68033744	EFR6601	MERITOR	68033912M17	EFR6656
MERITOR	68033746	EFR6600	MERITOR	68033913	EFR6657
MERITOR	68033747	EFR6601	MERITOR	68033913M17	EFR6657
MERITOR	68033748	EFR6600	MERITOR	68033920	EFR7624
MERITOR	68033748M16	EFR6600	MERITOR	68033921	EFR7625
MERITOR	68033749	EFR6601	MERITOR	68033922	EFR7622
MERITOR	68033749M16	EFR6601	MERITOR	68033923	EFR7623
MERITOR	68033752	EFR7706	MERITOR	68033924	EFR7630
MERITOR	68033752M02	EFR7706	MERITOR	68033925	EFR7631
MERITOR	68033753	EFR7707	MERITOR	68033926	EFR6620
MERITOR	68033753M02	EFR7707	MERITOR	68033927	EFR6621
MERITOR	68033757	EFR6603	MERITOR	68033928	EFR7628
MERITOR	68033758	EFR6602	MERITOR	68033929	EFR7629
MERITOR	68033761	EFR7706	MERITOR	68033940	EFR7612
MERITOR	68033762	EFR7707	MERITOR	68033940M10	EFR7612
MERITOR	68033772	EFR6602	MERITOR	68033941	EFR7613
MERITOR	68033773	EFR6603	MERITOR	68033941M10	EFR7613
MERITOR	68033774	EFR6602	MERITOR	68033944	EFR7686
MERITOR	68033775	EFR6603	MERITOR	68033944M10	EFR7686
MERITOR	68033810	EFR7678	MERITOR	68033945	EFR7687
MERITOR	68033811	EFR7679	MERITOR	68033945M10	EFR7687
MERITOR	68033812	EFR7688	MERITOR	68033950	EFR7684
MERITOR	68033813	EFR7689	MERITOR	68033950M10	EFR7684
MERITOR	68033814	EFR7676	MERITOR	68033951	EFR7685
MERITOR	68033815	EFR7677	MERITOR	68033951M10	EFR7685
MERITOR	68033816	EFR7676R	MERITOR	68033954	EFR7686
MERITOR	68033817	EFR7677R	MERITOR	68033955	EFR7687
MERITOR	68033818	EFR7680	MERITOR	68033981	EFR7704
MERITOR	68033819	EFR7681	MERITOR	68033982	EFR7705
MERITOR	68033820	EFR7690	MERITOR	68033995	EFR7672
MERITOR	68033821	EFR7691	MERITOR	68033995NZP	EFR7672
MERITOR	68033822	EFR6600	MERITOR	68033996	EFR7673
MERITOR	68033823	EFR6601	MERITOR	68033996NZP	EFR7673
MERITOR	68033824	EFR6656	MERITOR	68034032	EFR7704
MERITOR	68033825	EFR6657	MERITOR	68034033	EFR7705
MERITOR	68033835	EFR7638	MERITOR	68034122	EFR7664
MERITOR	68033836	EFR7639	MERITOR	68034123	EFR7665
MERITOR	68033902	EFR7668	MERITOR	68034153	EFR7664
MERITOR	68033903	EFR7669	MERITOR	68034154	EFR7665
MERITOR	68033906	EFR7668	MERITOR	68320504NGZ	2903005392
MERITOR	68033906NZP	EFR7668	MERITOR	68320504NGZ	2903009

Les correspondances de références ont pour seul objectif d'aider la recherche de référence

Cross references are there for the sole purpose of helping the reference search

CORRESPONDANCES DES REFERENCES CROSS REFERENCE LIST

MARQUE/MAKER	REF/PN OES	REF/PN	MARQUE/MAKER	REF/PN OES	REF/PN
MERITOR	68320504NGZ	CVP013K	MERITOR	68325072	EFR7624
MERITOR	68322655PK10	CAC001	MERITOR	68325073	EFR7625
MERITOR	68323232	DF713813	MERITOR	68325074	EFR7624
MERITOR	68323233	93243000	MERITOR	68325075	EFR7625
MERITOR	68323353	EFR7692	MERITOR	68325326-4	EFR6602
MERITOR	68323354	EFR7693	MERITOR	68325346	2913105
MERITOR	68323355	08.8060.10	MERITOR	68325346	CVP088K
MERITOR	68323355	93105100	MERITOR	68325372	09.E166.10
MERITOR	68323355	FCR245A	MERITOR	68325372	FCR347A
MERITOR	68323669	EFR7656	MERITOR	68325986	09.8059.20
MERITOR	68323670	EFR7657	MERITOR	68325986	93105000
MERITOR	68323740	08.8383.10	MERITOR	68325986	FCR244A
MERITOR	68323740	93193000	MERITOR	68326015	2913105
MERITOR	68323740	FCR337A	MERITOR	68326015	CVP088K
MERITOR	68323740	FCR344A	MERITOR	68326055	2921101
MERITOR	68323785	98027600	MERITOR	A23263A1171	EFR7715
MERITOR	68323785	W0355RT1V1	MERITOR	A23263Z1170	EFR7714
MERITOR	68323825	93192700	MERITOR	A63263A1171	EFR7671
MERITOR	68323825	FCR250A	MERITOR	A63263Z1170	EFR7670
MERITOR	68324072	98032400	MERITOR	A83222A2367	29180XX
MERITOR	68324072	W0290MA1	MERITOR	A93222A2367	29180XX
MERITOR	68324518	EFR7630	MERITOR	DSB7	CAC016
MERITOR	68324519	EFR7631	MERITOR	DX19525	EFR6650
MERITOR	68324553	EFR7616	MERITOR	DX19526	EFR6651
MERITOR	68324554	EFR7617	MERITOR	DX19533	EFR6650
MERITOR	68324558	2913105	MERITOR	DX19534	EFR6651
MERITOR	68324558	CVP088K	MERITOR	DX19547	EFR6650
MERITOR	68324558NZZ	2913105	MERITOR	DX19548	EFR6651
MERITOR	68324558NZZ	2913115	MERITOR	DX19551	EFR6650
MERITOR	68324558NZZ	CVP088K	MERITOR	DX19552	EFR6651
MERITOR	68324665	2917705	MERITOR	DX22521	EFR7670
MERITOR	68324665	CVP095K	MERITOR	DX22522	EFR7671
MERITOR	68325054	EFR7618	MERITOR	KIT2252H2CD	2918701
MERITOR	68325055	EFR7619	MERITOR	LRG522	EFR7652
MERITOR	68325058	EFR6620	MERITOR	LRG523	EFR7653
MERITOR	68325059	EFR6621	MERITOR	LRG524	EFR7600
MERITOR	68325060	EFR6626	MERITOR	LRG525	EFR7601
MERITOR	68325061	EFR6627	MERITOR	LRG526	EFR7602
MERITOR	68325062	EFR7628	MERITOR	LRG527	EFR7603
MERITOR	68325063	EFR7629	MERITOR	LRG528	EFR7606
MERITOR	68325064	EFR7630	MERITOR	LRG529	EFR7607
MERITOR	68325065	EFR7631	MERITOR	LRG530	EFR7710
MERITOR	68325066	EFR7630	MERITOR	LRG531	EFR7711
MERITOR	68325067	EFR7631	MERITOR	LRG532	EFR7604
MERITOR	68325068	EFR7622	MERITOR	LRG533	EFR7605
MERITOR	68325069	EFR7623	MERITOR	LRG536	EFR7630
MERITOR	68325070	EFR7622	MERITOR	LRG537	EFR7631
MERITOR	68325071	EFR7623	MERITOR	LRG540	EFR7636

Les correspondances de références ont pour seul objectif d'aider la recherche de référence

Cross references are there for the sole purpose of helping the reference search

CORRESPONDANCES DES REFERENCES CROSS REFERENCE LIST

MARQUE/MAKER	REF/PN OES	REF/PN	MARQUE/MAKER	REF/PN OES	REF/PN
MERITOR	LRG541	EFR7637	MERITOR	LRG617	EFR7697
MERITOR	LRG542	EFR7644	MERITOR	LRG622	EFR7608
MERITOR	LRG543	EFR7645	MERITOR	LRG623	EFR7609
MERITOR	LRG544	EFR7694	MERITOR	LRG630	EFR7614
MERITOR	LRG545	EFR7695	MERITOR	LRG631	EFR7615
MERITOR	LRG548	EFR7610	MERITOR	LRG632	EFR7636
MERITOR	LRG549	EFR7611	MERITOR	LRG633	EFR7637
MERITOR	LRG550	EFR7612	MERITOR	LRG638	EFR7716
MERITOR	LRG551	EFR7613	MERITOR	LRG639	EFR7717
MERITOR	LRG552	EFR7618	MERITOR	LRG642	EFR7638
MERITOR	LRG553	EFR7619	MERITOR	LRG643	EFR7639
MERITOR	LRG554	EFR6654	MERITOR	LRG646	EFR7662
MERITOR	LRG555	EFR6655	MERITOR	LRG647	EFR7663
MERITOR	LRG560	EFR6620	MERITOR	LRG648	EFR6626
MERITOR	LRG561	EFR6621	MERITOR	LRG649	EFR6627
MERITOR	LRG562	EFR7606	MERITOR	LRG650	EFR7628
MERITOR	LRG563	EFR7607	MERITOR	LRG651	EFR7629
MERITOR	LRG564	EFR7612	MERITOR	LRG652	EFR7630
MERITOR	LRG565	EFR7613	MERITOR	LRG653	EFR7631
MERITOR	LRG570	EFR7632	MERITOR	LRG654	EFR6650
MERITOR	LRG571	EFR7633	MERITOR	LRG655	EFR6651
MERITOR	LRG572	EFR7692	MERITOR	LRG656	EFR7712
MERITOR	LRG573	EFR7693	MERITOR	LRG657	EFR7713
MERITOR	LRG574	EFR7646	MERITOR	LRG658	EFR7664
MERITOR	LRG575	EFR7647	MERITOR	LRG659	EFR7665
MERITOR	LRG576	EFR7656	MERITOR	LRG662	EFR7698
MERITOR	LRG577	EFR7657	MERITOR	LRG663	EFR7699
MERITOR	LRG578	EFR7616	MERITOR	LRG664	EFR7666
MERITOR	LRG579	EFR7617	MERITOR	LRG665	EFR7667
MERITOR	LRG580	EFR7658	MERITOR	LRG669	EFR7706
MERITOR	LRG581	EFR7659	MERITOR	LRG670	EFR7707
MERITOR	LRG582	EFR7660	MERITOR	LRG700	EFR7668
MERITOR	LRG583	EFR7661	MERITOR	LRG701	EFR7669
MERITOR	LRG586	EFR7648	MERITOR	LRG702	EFR6602
MERITOR	LRG587	EFR7649	MERITOR	LRG703	EFR6603
MERITOR	LRG588	EFR7634	MERITOR	LRG704	EFR7640
MERITOR	LRG589	EFR7635	MERITOR	LRG705	EFR7641
MERITOR	LRG590	EFR7642	MERITOR	LRG708	EFR7714
MERITOR	LRG591	EFR7643	MERITOR	LRG709	EFR7715
MERITOR	LRG592	EFR7612	MERITOR	LRG710	EFR7670
MERITOR	LRG593	EFR7613	MERITOR	LRG711	EFR7671
MERITOR	LRG594	EFR6654	MERITOR	LRG712	EFR7672
MERITOR	LRG595	EFR6655	MERITOR	LRG713	EFR7673
MERITOR	LRG596	EFR7622	MERITOR	LRG720	EFR7700
MERITOR	LRG597	EFR7623	MERITOR	LRG721	EFR7701
MERITOR	LRG598	EFR7624	MERITOR	LRG722	EFR7702
MERITOR	LRG599	EFR7625	MERITOR	LRG723	EFR7703
MERITOR	LRG616	EFR7696	MERITOR	LRG724	EFR7674

Les correspondances de références ont pour seul objectif d'aider la recherche de référence

Cross references are there for the sole purpose of helping the reference search

CORRESPONDANCES DES REFERENCES CROSS REFERENCE LIST

MARQUE/MAKER	REF/PN OES	REF/PN	MARQUE/MAKER	REF/PN OES	REF/PN
MERITOR	LRG725	EFR7675	MERITOR	MBR9011	08.8383.10
MERITOR	LRG726	EFR7676R	MERITOR	MBR9011	93193000
MERITOR	LRG727	EFR7677R	MERITOR	MBR9011	FCR337A
MERITOR	LRG728	EFR7688	MERITOR	MBR9011	FCR344A
MERITOR	LRG729	EFR7689	MERITOR	MBR9012	FCR377A
MERITOR	LRG730	EFR7690	MERITOR	MBR9013	93243400
MERITOR	LRG731	EFR7691	MERITOR	MBR9013	FCR353A
MERITOR	LRG732	EFR6656	MERITOR	MBR9014	09.E166.10
MERITOR	LRG733	EFR6657	MERITOR	MBR9014	FCR347A
MERITOR	LRG734	EFR7676	MERITOR	MBR9017	93127900
MERITOR	LRG735	EFR7677	MERITOR	MBR9017	FCR248A
MERITOR	LRG736	EFR7678	MERITOR	MBR9018	09.8979.10
MERITOR	LRG737	EFR7679	MERITOR	MBR9018	93117700
MERITOR	LRG738	EFR7680	MERITOR	MBR9020	DF713889
MERITOR	LRG739	EFR7681	MERITOR	MCK1071	W0400MA1
MERITOR	LRG740	EFR6600	MERITOR	MCK1102	CAC014
MERITOR	LRG741	EFR6601	MERITOR	MCK1103	CAC029
MERITOR	LRG744	EFR7684	MERITOR	MCK1116	CAC013
MERITOR	LRG745	EFR7685	MERITOR	MCK1134	CAC013
MERITOR	LRG746	EFR6602	MERITOR	MCK1139	CAC011
MERITOR	LRG747	EFR6603	MERITOR	MCK1140	CAC012
MERITOR	LRG748	EFR7718	MERITOR	MCK1171	CAC016
MERITOR	LRG749	EFR7719	MERITOR	MCK1174	CAC040
MERITOR	LRG750	EFR7720	MERITOR	MCK1243	CAC012
MERITOR	LRG751	EFR7721	MERITOR	MCK1254	CAC015
MERITOR	LRG752	EFR7638	MERITOR	MCK1278	EFR7630
MERITOR	LRG753	EFR7639	MERITOR	MCK1279	EFR7631
MERITOR	LRG756	EFR7686	MERITOR	MCK1280	EFR7622
MERITOR	LRG757	EFR7687	MERITOR	MCK1281	EFR7623
MERITOR	LRG764	EFR7704	MERITOR	MCK1284	EFR6620
MERITOR	LRG765	EFR7705	MERITOR	MCK1285	EFR6621
MERITOR	MBAKIT1051	W0760BP	MERITOR	MCK1286	EFR7624
MERITOR	MBR9000	DF713813	MERITOR	MCK1287	EFR7625
MERITOR	MBR9001	93243000	MERITOR	MCK1298	CAC028
MERITOR	MBR9001	FCR278A	MERITOR	MCK1317	CAC027
MERITOR	MBR9002	08.8240.10	MERITOR	MCK1331	EFR6603
MERITOR	MBR9002	93308600	MERITOR	MCK1332	EFR6602
MERITOR	MBR9002	FCR303A	MERITOR	MCK1345	EFR7692
MERITOR	MBR9003	DF713814	MERITOR	MCK1346	EFR7693
MERITOR	MBR9004	09.8579.10	MERITOR	MCK1376	EFR7676R
MERITOR	MBR9004	93192700	MERITOR	MCK1377	EFR7677R
MERITOR	MBR9004	FCR250A	MERITOR	MCK1381	EFR7704
MERITOR	MBR9007	08.8060.10	MERITOR	MCK1382	EFR7705
MERITOR	MBR9007	93105100	MERITOR	MCK1385	EFR7688
MERITOR	MBR9007	FCR245A	MERITOR	MCK1386	EFR7689
MERITOR	MBR9008	09.7870.10	MERITOR	MCK1387	EFR6656
MERITOR	MBR9008	93086100	MERITOR	MCK1387	EFR7690
MERITOR	MBR9008	FCR134A	MERITOR	MCK1388	EFR6657

Les correspondances de références ont pour seul objectif d'aider la recherche de référence

Cross references are there for the sole purpose of helping the reference search

CORRESPONDANCES DES REFERENCES CROSS REFERENCE LIST

MARQUE/MAKER	REF/PN OES	REF/PN	MARQUE/MAKER	REF/PN OES	REF/PN
MERITOR	MCK1388	EFR7691	MERITOR	MDP5088	CVP013K
MERITOR	MDP5000	2903009	MERITOR	MDP5090	2903007
MERITOR	MDP5000	CVP013K	MERITOR	MDP5090	CVP013K
MERITOR	MDP5008	2904303	MERITOR	MDP5091	2903009
MERITOR	MDP5017	2908302	MERITOR	MDP5091	CVP013K
MERITOR	MDP5017	CVP013K	MERITOR	MDP5093	2917705
MERITOR	MDP5019	2909006	MERITOR	MDP5093	CVP095K
MERITOR	MDP5019	CVP023K	MERITOR	MDP5097	2913103
MERITOR	MDP5027	2904303	MERITOR	MDP5097	CVP088K
MERITOR	MDP5031	2903009	MERITOR	MDP5099	2913111
MERITOR	MDP5031	CVP013K	MERITOR	MDP5099	CVP088K
MERITOR	MDP5032	2905301	MERITOR	MDP5101	2917400604
MERITOR	MDP5033	2903009	MERITOR	MDP5101	2917403
MERITOR	MDP5033	CVP013K	MERITOR	MDP5101	CVP101K
MERITOR	MDP5035	2910004	MERITOR	MDP5102	2917300604
MERITOR	MDP5037	2910004	MERITOR	MDP5102	2917303
MERITOR	MDP5038	2911303	MERITOR	MDP5102	CVP100K
MERITOR	MDP5039	2905301	MERITOR	MDP5103	2917705
MERITOR	MDP5042	2909015	MERITOR	MDP5103	CVP095K
MERITOR	MDP5042	CVP023K	MERITOR	MDP5104	2917400604
MERITOR	MDP5045	2911303	MERITOR	MDP5104	2917401
MERITOR	MDP5050	CVP013K	MERITOR	MDP5104	CVP101K
MERITOR	MDP5051	CVP013K	MERITOR	MDP5106	2917300604
MERITOR	MDP5052	2913606	MERITOR	MDP5106	2917301
MERITOR	MDP5053	2913706	MERITOR	MDP5106	CVP100K
MERITOR	MDP5054	2911303	MERITOR	MDP5108	2917705
MERITOR	MDP5056	2913115	MERITOR	MDP5108	CVP095K
MERITOR	MDP5056	CVP088K	MERITOR	MDP5110	2903009
MERITOR	MDP5057	2927705	MERITOR	MDP5110	CVP013K
MERITOR	MDP5057	CVP037K	MERITOR	MDP5111	2913105
MERITOR	MDP5059	2913103	MERITOR	MDP5111	CVP088K
MERITOR	MDP5059	CVP088K	MERITOR	MDP5112	2913103
MERITOR	MDP5060	2913103	MERITOR	MDP5112	CVP088K
MERITOR	MDP5060	CVP088K	MERITOR	MDP5116	2913105
MERITOR	MDP5061	2909006	MERITOR	MDP5116	CVP088K
MERITOR	MDP5061	CVP023K	MERITOR	MDP5117	2921101
MERITOR	MDP5065	2911307	MERITOR	MDP5119	2917400604
MERITOR	MDP5066	2911401	MERITOR	MDP5119	2917401
MERITOR	MDP5071	2909006	MERITOR	MDP5119	CVP101K
MERITOR	MDP5071	CVP023K	MERITOR	MDP5120	2905301
MERITOR	MDP5072	2915102	MERITOR	MDP5121	2913115
MERITOR	MDP5073	2913105	MERITOR	MDP5121	CVP088K
MERITOR	MDP5073	CVP088K	MERITOR	MDP5122	2925305390
MERITOR	MDP5076	2912405	MERITOR	MDP5122	CVP020K
MERITOR	MDP5076	CVP024K	MERITOR	MMD1310AF	2913103
MERITOR	MDP5083	2915001	MERITOR	MMD1310AF	CVP088K
MERITOR	MDP5083K	2915001	MERITOR	MXC3044	EFR7658
MERITOR	MDP5088	2903007	MERITOR	MXC3045	EFR7659

Les correspondances de références ont pour seul objectif d'aider la recherche de référence

Cross references are there for the sole purpose of helping the reference search

CORRESPONDANCES DES REFERENCES CROSS REFERENCE LIST

MARQUE/MAKER	REF/PN OES	REF/PN	MARQUE/MAKER	REF/PN OES	REF/PN
MERITOR	MXC3060	EFR7610	NEOPLAN	11015508	93086800
MERITOR	MXC3061	EFR7611	NEOPLAN	11015508	FCR168A
MERITOR	MXC3180	EFR7668	NEOPLAN	11015516	EFR7303
MERITOR	MXC3181	EFR7669	NEOPLAN	11015565	CAC005
MERITOR	MXC4836	EFR6650	NEOPLAN	11015716	2905503
MERITOR	MXC4837	EFR6651	NEOPLAN	11067687	EFR7311
MERITOR	MXC548	EFR7610	NEOPLAN	11067690	EFR7310
MERITOR	MXC549	EFR7611	NEOPLAN	14011215	EFR7315
MERITOR	MXC580	EFR7658	NEOPLAN	14011853	EFR7314
MERITOR	MXC581	EFR7659	NEOPLAN	14011855	EFR7317
MERITOR	MXC700	EFR7668	NEOPLAN	14011856	EFR7316
MERITOR	MXC701	EFR7669	NEOPLAN	14016905	EFR7303
MERITOR	SJ4039	EFR7610	NEOPLAN	14017301	EFR7302
MERITOR	SJ4040	EFR7611	NEOPLAN	14017318	EFR7311
MERITOR	ST1156	CAC030	NEOPLAN	14017319	EFR7310
MERITOR	ST1157	CAC014	NEOPLAN	14022999	EFR7317
MERITOR	ST1192	CAC014	NEOPLAN	14023000	EFR7316
MULTIPART	DEP102763	CAC025	NEOPLAN	501005859	EFR7302
MULTIPART	DEP102766	CAC009	NEOPLAN	501005860	EFR7303
MULTIPART	DEP102953	CAC008	NEOPLAN	72139910	EFR7315
MULTIPART	DEP103079	CAC025	NEOPLAN	72139920	EFR7314
MULTIPART	DEP103080	CAC025	NEOPLAN	80455700	2907702
NEOPLAN	072136218	09.B325.40	NEOPLAN	82133310	93086700
NEOPLAN	072136218	93086800	NEOPLAN	82133310	FCR167A
NEOPLAN	072136218	FCR168A	NEOPLAN	82135100	2920200604
NEOPLAN	072139910	EFR7315	NEOPLAN	82135100	2925305390
NEOPLAN	072139920	EFR7314	NEOPLAN	82135100	2927801
NEOPLAN	082135830	09.B325.40	NEOPLAN	82135100	2927802
NEOPLAN	082135830	93086800	NEOPLAN	82135100	CVP020K
NEOPLAN	082135830	FCR168A	NEOPLAN	82135210	98032300
NEOPLAN	082136000	EFR7302	NEOPLAN	82135210	W0310NE3
NEOPLAN	082136010	EFR7303	NEOPLAN	82135830	93086800
NEOPLAN	082136200	EFR7302	NEOPLAN	82136000	EFR7302
NEOPLAN	082136210	EFR7303	NEOPLAN	82136010	EFR7303
NEOPLAN	082136300	EFR7303	NEOPLAN	82136200	EFR7302
NEOPLAN	082136400	EFR7302	NEOPLAN	82136210	EFR7303
NEOPLAN	082331100	2905503	NEOPLAN	82136300	EFR7303
NEOPLAN	0911015449	93086700	NEOPLAN	82136400	EFR7302
NEOPLAN	0911015449	FCR167A	NEOPLAN	8285515000	EFR7300
NEOPLAN	11014051	CAC008	NEOPLAN	82855156230	EFR7301
NEOPLAN	11014064	EFR7303	NEOPLAN	82855156240	EFR7300
NEOPLAN	11014065	EFR7302	NEOPLAN	8285516000	EFR7301
NEOPLAN	11014139	EFR7315	NEOPLAN	88000108505	EFR7304
NEOPLAN	11014147	EFR7314	NEOPLAN	89198005210	EFR7316
NEOPLAN	11014148	EFR7315	NEOPLAN	89198005220	EFR7317
NEOPLAN	11015479	EFR7302	NEOPLAN	89198005380	EFR7302
NEOPLAN	11015480	EFR7303	NEOPLAN	89198005390	EFR7303
NEOPLAN	11015508	09.B325.40	NEOPLAN	A8285515000	EFR7300

Les correspondances de références ont pour seul objectif d'aider la recherche de référence

Cross references are there for the sole purpose of helping the reference search

CORRESPONDANCES DES REFERENCES CROSS REFERENCE LIST

MARQUE/MAKER	REF/PN OES	REF/PN	MARQUE/MAKER	REF/PN OES	REF/PN
NEOPLAN	A8285516000	EFR7301	RABA	309503300LH	EFR7302
NEOPLAN	AQ8285515000	EFR7300	RABA	309503300RH	EFR7303
NEOPLAN	AQ8285516000	EFR7301	RABA	309853300	EFR7302
NEOPLAN	N1011015508	09.B325.40	RABA	309863300	EFR7303
NEOPLAN	N1011015508	93086800	RABA	309873300	EFR7302
NEOPLAN	N1011015508	FCR168A	RABA	309883300	EFR7303
NISSAN	41000D9201	EFR6655	RABA	309893300	EFR7302
NISSAN	41000D9203	EFR6655	RABA	309903300	EFR7303
NISSAN	41000LC55A	EFR5300	RABA	309913000	EFR7302
NISSAN	41010D9200	EFR6654	RABA	309923300	EFR7303
NISSAN	41010D9201	EFR6654	RABA	311003300LH	EFR7302
NISSAN	41010LC55A	EFR5301	RABA	311003300RH	EFR7303
NISSAN	411209X625	CAC019	RABA	311413300LH	EFR7302
NISSAN	440609X625	2931301	RABA	311413300RH	EFR7303
NISSAN	68321445	2910004	RABA	311503300	EFR7302
NISSAN	68321583	2910004	RABA	311513300	EFR7303
NISSAN	68321849	2910004	RABA	311603300	EFR7302
NISSAN	68322542	2910004	RABA	311613300	EFR7303
NISSAN	69029700	2910004	RABA	311623300	EFR7302
NISSAN	69030060	2910004	RABA	311633300	EFR7303
NISSAN	D1060LC55A	2918302	RABA	311643300	EFR7302
ORION	F0102502DE	EFR7606	RABA	311653300	EFR7303
ORION	F0102502DF	EFR7607	RABA	311703300	EFR7302
OSHKOSH	5009280	EFR7302	RABA	311713300	EFR7303
OSHKOSH	5009281	EFR7303	RABA	311723300	EFR7302
OTOKAR	13C3508236AA	EFR5002	RABA	311733300	EFR7303
OTOKAR	13C3508238AA	EFR5003	RABA	311823300	EFR7302
OTOKAR	13C3508274AA	2928503	RABA	311833300	EFR7303
OTOKAR	13C3508274AA	CVP032K	RABA	311853300	EFR7302
OTOKAR	13C3508276AA	CAC017	RABA	311863300	EFR7302
OTOKAR	16H0008310AA	EFR6306	RABA	311873300	EFR7302
OTOKAR	16H0008312AA	EFR6307	RABA	311883300	EFR7303
PACCAR	871054	CAC015	RABA	313503300	EFR7300
PREVOST	611049	2920200604	RABA	313513300	EFR7301
PREVOST	611049	2927802	RABA	313523300	EFR7300
PREVOST	611049	CVP020K	RABA	313533300	EFR7301
PREVOST	N8893599	2920200604	RABA	313543300	EFR7300
PREVOST	N8893599	2925305390	RABA	313553300	EFR7301
PREVOST	N8893599	2927802	RABA	332223100	EFR7300
PREVOST	N8893599	CVP020K	RABA	332233100	EFR7301
RABA	309003300	EFR7302	RABA	332243100	EFR7300
RABA	309013300	EFR7303	RABA	332253100	EFR7301
RABA	309203300	EFR7302	RABA	332313100	EFR7300
RABA	309213300	EFR7303	RABA	332323100	EFR7301
RABA	309303300	EFR7302	RABA	332593100	EFR7300
RABA	309313300	EFR7303	RABA	332603100	EFR7301
RABA	309323300	EFR7302	RABA	625210	EFR7606
RABA	309333300	EFR7303	RABA	625211	EFR7607

Les correspondances de références ont pour seul objectif d'aider la recherche de référence

Cross references are there for the sole purpose of helping the reference search

CORRESPONDANCES DES REFERENCES CROSS REFERENCE LIST

MARQUE/MAKER	REF/PN OES	REF/PN	MARQUE/MAKER	REF/PN OES	REF/PN
RABA	654173	EFR7300	RENAULT TRUCKS	20982075	EFR7690
RABA	654174	EFR7301	RENAULT TRUCKS	20982082	EFR7691
RABA	656588	CAC005	RENAULT TRUCKS	20982090	EFR7676R
RABA	656590	CAC008	RENAULT TRUCKS	20982091	EFR7677R
RABA	663780LH	EFR7316	RENAULT TRUCKS	20982104	EFR7690
RABA	663780RH	EFR7317	RENAULT TRUCKS	20982105	EFR7691
RABA	665176	EFR7300	RENAULT TRUCKS	20982111	EFR7676R
RABA	665177	EFR7301	RENAULT TRUCKS	20982113	EFR7677R
RABA	672203400	EFR7302	RENAULT TRUCKS	21487605	EFR7677R
RABA	672213400	EFR7303	RENAULT TRUCKS	21487686	EFR7676R
RABA	672303400	EFR7303	RENAULT TRUCKS	21487688	EFR7677R
RABA	672313400	EFR7303	RENAULT TRUCKS	21487694	EFR7690
RABA	672403400	EFR7302	RENAULT TRUCKS	21487695	EFR7691
RABA	672413400	EFR7303	RENAULT TRUCKS	5000294357	2904303
RABA	672453400	EFR7302	RENAULT TRUCKS	5000296049	EFR7652
RABA	672463400	EFR7303	RENAULT TRUCKS	5000296050	EFR7653
RABA	700513100	EFR7300	RENAULT TRUCKS	5000297198	2904303
RABA	700523100	EFR7301	RENAULT TRUCKS	5000297345	2904303
RABA	700533100	EFR7301	RENAULT TRUCKS	5000450158	09.6732.20
RABA	700543100	EFR7300	RENAULT TRUCKS	5000450158	93085900
RABA	700553100	EFR7300	RENAULT TRUCKS	5000450158	FCR126A
RABA	700563100	EFR7301	RENAULT TRUCKS	5000545242	09.6732.20
RABA	700583100	EFR7300	RENAULT TRUCKS	5000545242	93085900
RABA	700593100	EFR7301	RENAULT TRUCKS	5000545242	FCR126A
RABA	700603100	EFR7300	RENAULT TRUCKS	5000792539	93086000
RABA	700613100	EFR7301	RENAULT TRUCKS	5000792539	FCR128A
RABA	702013100	EFR7304	RENAULT TRUCKS	5000821964	2904303
RABA	702023100	EFR7305	RENAULT TRUCKS	5000823338	EFR7602
RABA	737748	EFR7300	RENAULT TRUCKS	5000823339	EFR7603
RABA	737749	EFR7301	RENAULT TRUCKS	5001019356	EFR7664
RABA	932213100	EFR7300	RENAULT TRUCKS	5001019357	EFR7665
RABA	932223100	EFR7301	RENAULT TRUCKS	5001019719	EFR7664
RABA	932233100	EFR7300	RENAULT TRUCKS	5001019720	EFR7665
RABA	932243100	EFR7301	RENAULT TRUCKS	5001020071	EFR7666
RABA	932253100	EFR7300	RENAULT TRUCKS	5001020073	EFR7667
RABA	932263100	EFR7301	RENAULT TRUCKS	5001020312	2913105
RABA	932323100	EFR7300	RENAULT TRUCKS	5001020312	2913115
RABA	932333100	EFR7301	RENAULT TRUCKS	5001020312	CVP088K
RABA	932343100	EFR7301	RENAULT TRUCKS	5001822987	2904303
RABA	932353100	EFR7301	RENAULT TRUCKS	5001822987	CVP009
RABA	932573100	EFR7300	RENAULT TRUCKS	5001823000	2903005392
RABA	932593100	EFR7301	RENAULT TRUCKS	5001823000	2903007
RABA	932613100	EFR7302	RENAULT TRUCKS	5001823000	2903024
RABA	932623100	EFR7303	RENAULT TRUCKS	5001823000	CVP013K
RENAULT TRUCKS	0504222950	EFR7672	RENAULT TRUCKS	5001825640	2904303
RENAULT TRUCKS	0504222951	EFR7673	RENAULT TRUCKS	5001825641	2904303
RENAULT TRUCKS	20578291	EFR6600	RENAULT TRUCKS	5001831161	2909015
RENAULT TRUCKS	20578292	EFR6601	RENAULT TRUCKS	5001831161	98025200

Les correspondances de références ont pour seul objectif d'aider la recherche de référence

Cross references are there for the sole purpose of helping the reference search

CORRESPONDANCES DES REFERENCES CROSS REFERENCE LIST

MARQUE/MAKER	REF/PN OES	REF/PN	MARQUE/MAKER	REF/PN OES	REF/PN
RENAULT TRUCKS	5001831161	CVP023K	RENAULT TRUCKS	5001858406	EFR7662
RENAULT TRUCKS	5001833104	2910004	RENAULT TRUCKS	5001858407	EFR7663
RENAULT TRUCKS	5001833114	2909015	RENAULT TRUCKS	5001858711	EFR7658
RENAULT TRUCKS	5001833114	CVP023K	RENAULT TRUCKS	5001858712	EFR7659
RENAULT TRUCKS	5001834075	2903005392	RENAULT TRUCKS	5001858719	CAC040
RENAULT TRUCKS	5001834075	98025200	RENAULT TRUCKS	5001858720	EFR6002
RENAULT TRUCKS	5001834075	98025500	RENAULT TRUCKS	5001858721	EFR6003
RENAULT TRUCKS	5001834075	CVP013K	RENAULT TRUCKS	5001858722	CAC018
RENAULT TRUCKS	5001834075	W0360RT	RENAULT TRUCKS	5001860184	09.B750.10
RENAULT TRUCKS	5001834448	2907203	RENAULT TRUCKS	5001860791	CAC012
RENAULT TRUCKS	5001836663	EFR7610	RENAULT TRUCKS	5001860794	EFR7669
RENAULT TRUCKS	5001836664	EFR7611	RENAULT TRUCKS	5001863324	2931301
RENAULT TRUCKS	5001837343	EFR7602	RENAULT TRUCKS	5001863904	2913115
RENAULT TRUCKS	5001837344	EFR7603	RENAULT TRUCKS	5001863904	CVP088K
RENAULT TRUCKS	5001845383	EFR6654	RENAULT TRUCKS	5001864363	2917400604
RENAULT TRUCKS	5001845384	EFR6655	RENAULT TRUCKS	5001864363	2917403
RENAULT TRUCKS	5001845388	CAC011	RENAULT TRUCKS	5001864363	CVP101K
RENAULT TRUCKS	5001846034	2909015	RENAULT TRUCKS	5001864364	2917400604
RENAULT TRUCKS	5001846034	CVP023K	RENAULT TRUCKS	5001864364	2917403
RENAULT TRUCKS	5001848363	98031900	RENAULT TRUCKS	5001864364	CVP101K
RENAULT TRUCKS	5001848363	W0400RT	RENAULT TRUCKS	5001864365	2917300604
RENAULT TRUCKS	5001849885	CAC014	RENAULT TRUCKS	5001864365	2917303
RENAULT TRUCKS	5001849886	CAC030	RENAULT TRUCKS	5001864365	CVP100K
RENAULT TRUCKS	5001851557	EFR7656	RENAULT TRUCKS	5001864380	2917705
RENAULT TRUCKS	5001851558	EFR7657	RENAULT TRUCKS	5001864380	CVP095K
RENAULT TRUCKS	5001851559	EFR7638	RENAULT TRUCKS	5001864465	EFR7602
RENAULT TRUCKS	5001851560	EFR7639	RENAULT TRUCKS	5001864466	EFR7603
RENAULT TRUCKS	5001852882	EFR5000	RENAULT TRUCKS	5001864469	EFR7652
RENAULT TRUCKS	5001852883	EFR5001	RENAULT TRUCKS	5001864470	EFR7653
RENAULT TRUCKS	5001854335	EFR7658	RENAULT TRUCKS	5001864471	EFR6654
RENAULT TRUCKS	5001854336	EFR7659	RENAULT TRUCKS	5001864472	EFR6655
RENAULT TRUCKS	5001854338	EFR7660	RENAULT TRUCKS	5001864498	93272000
RENAULT TRUCKS	5001854339	EFR7661	RENAULT TRUCKS	5001864498	DF70010
RENAULT TRUCKS	5001854341	2903007	RENAULT TRUCKS	5001864498	FCR259A
RENAULT TRUCKS	5001854341	CVP013K	RENAULT TRUCKS	5001865750	2909015
RENAULT TRUCKS	5001854342	2903007	RENAULT TRUCKS	5001865750	CVP023K
RENAULT TRUCKS	5001854342	CVP013K	RENAULT TRUCKS	5001865904	EFR6008
RENAULT TRUCKS	5001854741	EFR7610	RENAULT TRUCKS	5001865905	EFR6009
RENAULT TRUCKS	5001854742	EFR7611	RENAULT TRUCKS	5001865918	EFR6004
RENAULT TRUCKS	5001855646	2913115	RENAULT TRUCKS	5001865919	EFR6005
RENAULT TRUCKS	5001855646	CVP088K	RENAULT TRUCKS	5001866385	CAC027
RENAULT TRUCKS	5001855656	2913105	RENAULT TRUCKS	5001866428	EFR7676
RENAULT TRUCKS	5001855656	CVP088K	RENAULT TRUCKS	5001866429	EFR7677
RENAULT TRUCKS	5001855902	FCV1389	RENAULT TRUCKS	5001866486	CAC040
RENAULT TRUCKS	5001855902	W0450RT1	RENAULT TRUCKS	5001866508	EFR7678
RENAULT TRUCKS	5001857615	2910004	RENAULT TRUCKS	5001866509	EFR7679
RENAULT TRUCKS	5001858404	EFR7668	RENAULT TRUCKS	5001866626	CAC019
RENAULT TRUCKS	5001858405	EFR7669	RENAULT TRUCKS	5001866914	2918100604

Les correspondances de références ont pour seul objectif d'aider la recherche de référence

Cross references are there for the sole purpose of helping the reference search

CORRESPONDANCES DES REFERENCES CROSS REFERENCE LIST

MARQUE/MAKER	REF/PN OES	REF/PN	MARQUE/MAKER	REF/PN OES	REF/PN
RENAULT TRUCKS	5001866914	2918101	RENAULT TRUCKS	5010216437	09.7870.10
RENAULT TRUCKS	5001866951	2928501	RENAULT TRUCKS	5010216437	93086100
RENAULT TRUCKS	5001866951	CVP032K	RENAULT TRUCKS	5010216437	FCR134A
RENAULT TRUCKS	5001866984	EFR7680	RENAULT TRUCKS	5010216548	93086000
RENAULT TRUCKS	5001866985	EFR7681	RENAULT TRUCKS	5010216548	FCR128A
RENAULT TRUCKS	5001866989	CAC028	RENAULT TRUCKS	5010216586	EFR7653
RENAULT TRUCKS	5001866990	EFR6600	RENAULT TRUCKS	5010216587	EFR7652
RENAULT TRUCKS	5001866991	EFR6601	RENAULT TRUCKS	5010216588	EFR7653
RENAULT TRUCKS	5001867588	EFR6200	RENAULT TRUCKS	5010216833	EFR7602
RENAULT TRUCKS	5001867798	93322700	RENAULT TRUCKS	5010216834	EFR7603
RENAULT TRUCKS	5001867798	DF70009	RENAULT TRUCKS	5010260004	EFR7610
RENAULT TRUCKS	5001867798	FCR348A	RENAULT TRUCKS	5010260005	EFR7611
RENAULT TRUCKS	5001867799	93322800	RENAULT TRUCKS	5010260214	EFR6654
RENAULT TRUCKS	5001867799	DF70011	RENAULT TRUCKS	5010260215	EFR6655
RENAULT TRUCKS	5001867799	FCR328A	RENAULT TRUCKS	5010260218	93192000
RENAULT TRUCKS	5001872019	EFR7610	RENAULT TRUCKS	5010260218	FCR185A
RENAULT TRUCKS	5001872020	EFR7611	RENAULT TRUCKS	5010260423	EFR7610
RENAULT TRUCKS	5001872032	EFR7658	RENAULT TRUCKS	5010260424	EFR7611
RENAULT TRUCKS	5001872033	EFR7659	RENAULT TRUCKS	5010260444	EFR7602
RENAULT TRUCKS	5001872042	EFR7668	RENAULT TRUCKS	5010260445	EFR7603
RENAULT TRUCKS	5001872043	EFR7669	RENAULT TRUCKS	5010393349	EFR7656
RENAULT TRUCKS	5001963243	EFR7674	RENAULT TRUCKS	5010393350	EFR7657
RENAULT TRUCKS	5001963244	EFR7675	RENAULT TRUCKS	5010393685	EFR7611
RENAULT TRUCKS	5004134958	09.8059.20	RENAULT TRUCKS	5010393686	EFR7610
RENAULT TRUCKS	5004134958	93105000	RENAULT TRUCKS	5010422260	EFR5000
RENAULT TRUCKS	5004134958	FCR244A	RENAULT TRUCKS	5010422261	EFR5001
RENAULT TRUCKS	5006172150	09.7870.10	RENAULT TRUCKS	5010422262	09.9492.20
RENAULT TRUCKS	5006172476	EFR7672	RENAULT TRUCKS	5010422262	93192600
RENAULT TRUCKS	5006172477	EFR7673	RENAULT TRUCKS	5010422262	DF50001
RENAULT TRUCKS	5010019249	09.5319.10	RENAULT TRUCKS	5010422262	FCR218A
RENAULT TRUCKS	5010019249	93086300	RENAULT TRUCKS	5010422263	09.9493.60
RENAULT TRUCKS	5010019249	FCR127A	RENAULT TRUCKS	5010422263	93192200
RENAULT TRUCKS	501007742	EFR7684	RENAULT TRUCKS	5010422263	DF50002
RENAULT TRUCKS	501007743	EFR7685	RENAULT TRUCKS	5010422263	FCR219A
RENAULT TRUCKS	5010104739	2907203	RENAULT TRUCKS	5010422264	08.8060.10
RENAULT TRUCKS	5010151214	2907203	RENAULT TRUCKS	5010422264	93105100
RENAULT TRUCKS	5010190857	2907203	RENAULT TRUCKS	5010422264	FCR245A
RENAULT TRUCKS	5010190865	09.5319.10	RENAULT TRUCKS	5010422363	09.7870.10
RENAULT TRUCKS	5010190865	93086300	RENAULT TRUCKS	5010422363	09.8059.20
RENAULT TRUCKS	5010190865	FCR127A	RENAULT TRUCKS	5010422363	93086100
RENAULT TRUCKS	5010197487	2907203	RENAULT TRUCKS	5010422363	93105000
RENAULT TRUCKS	5010207049	2907203	RENAULT TRUCKS	5010422363	FCR134A
RENAULT TRUCKS	5010207431	09.5319.10	RENAULT TRUCKS	5010422363	FCR244A
RENAULT TRUCKS	5010207431	93086300	RENAULT TRUCKS	5010422364	08.8060.10
RENAULT TRUCKS	5010207431	FCR127A	RENAULT TRUCKS	5010422364	93105100
RENAULT TRUCKS	5010216431	09.5319.10	RENAULT TRUCKS	5010422364	FCR245A
RENAULT TRUCKS	5010216431	93086300	RENAULT TRUCKS	5010422365	EFR7658
RENAULT TRUCKS	5010216431	FCR127A	RENAULT TRUCKS	5010422366	EFR7659

Les correspondances de références ont pour seul objectif d'aider la recherche de référence

Cross references are there for the sole purpose of helping the reference search

CORRESPONDANCES DES REFERENCES CROSS REFERENCE LIST

MARQUE/MAKER	REF/PN OES	REF/PN	MARQUE/MAKER	REF/PN OES	REF/PN
RENAULT TRUCKS	5010422367	EFR7658	RENAULT TRUCKS	5010525308	DF50001
RENAULT TRUCKS	5010422368	EFR7659	RENAULT TRUCKS	5010525308	FCR218A
RENAULT TRUCKS	5010422369	EFR7660	RENAULT TRUCKS	5010525326	08.8383.10
RENAULT TRUCKS	5010422370	EFR7661	RENAULT TRUCKS	5010525326	93193000
RENAULT TRUCKS	5010422431	EFR7658	RENAULT TRUCKS	5010525326	FCR337A
RENAULT TRUCKS	5010422432	EFR7659	RENAULT TRUCKS	5010525326	FCR344A
RENAULT TRUCKS	5010422433	EFR7658	RENAULT TRUCKS	5010525362	09.9495.40
RENAULT TRUCKS	5010422434	EFR7659	RENAULT TRUCKS	5010525362	93192300
RENAULT TRUCKS	5010422435	EFR7660	RENAULT TRUCKS	5010525362	DF60001
RENAULT TRUCKS	5010422436	EFR7661	RENAULT TRUCKS	5010525362	FCR325A
RENAULT TRUCKS	5010422510	EFR7658	RENAULT TRUCKS	5010525364	09.9496.10
RENAULT TRUCKS	5010422511	EFR7659	RENAULT TRUCKS	5010525364	93192500
RENAULT TRUCKS	5010422593	09.7870.10	RENAULT TRUCKS	5010525364	FCR378A
RENAULT TRUCKS	5010422593	93086100	RENAULT TRUCKS	5010525474	EFR6654
RENAULT TRUCKS	5010422593	FCR134A	RENAULT TRUCKS	5010525475	EFR6655
RENAULT TRUCKS	5010422983	EFR7658	RENAULT TRUCKS	5010525477	EFR7668
RENAULT TRUCKS	5010422984	EFR7659	RENAULT TRUCKS	5010525478	EFR7669
RENAULT TRUCKS	5010422985	EFR7658	RENAULT TRUCKS	5010525479	EFR7668
RENAULT TRUCKS	5010422986	EFR7659	RENAULT TRUCKS	5010525480	EFR7669
RENAULT TRUCKS	5010422987	EFR7660	RENAULT TRUCKS	5010525481	EFR7668
RENAULT TRUCKS	5010422988	EFR7661	RENAULT TRUCKS	5010525482	EFR7669
RENAULT TRUCKS	5010422989	EFR7658	RENAULT TRUCKS	5010525483	EFR7662
RENAULT TRUCKS	5010422990	EFR7659	RENAULT TRUCKS	5010525484	EFR7663
RENAULT TRUCKS	5010422991	EFR7658	RENAULT TRUCKS	5010525485	EFR7662
RENAULT TRUCKS	5010422992	EFR7659	RENAULT TRUCKS	5010525486	EFR7663
RENAULT TRUCKS	5010422993	EFR7660	RENAULT TRUCKS	5010525487	EFR7668
RENAULT TRUCKS	5010422994	EFR7661	RENAULT TRUCKS	5010525488	EFR7669
RENAULT TRUCKS	5010512466	EFR7666	RENAULT TRUCKS	5010525489	EFR7668
RENAULT TRUCKS	5010512467	EFR7667	RENAULT TRUCKS	5010525490	EFR7669
RENAULT TRUCKS	5010522479	EFR7668	RENAULT TRUCKS	5010525491	EFR7668
RENAULT TRUCKS	5010522480	EFR7669	RENAULT TRUCKS	5010525492	EFR7669
RENAULT TRUCKS	5010525012	EFR6002	RENAULT TRUCKS	5010525493	EFR7662
RENAULT TRUCKS	5010525013	EFR6003	RENAULT TRUCKS	5010525494	EFR7663
RENAULT TRUCKS	5010525014	09.B845.20	RENAULT TRUCKS	5010525495	EFR7662
RENAULT TRUCKS	5010525014	93192400	RENAULT TRUCKS	5010525496	EFR7663
RENAULT TRUCKS	5010525014	FCR242A	RENAULT TRUCKS	5010525498	EFR7669
RENAULT TRUCKS	5010525040	EFR7660	RENAULT TRUCKS	5010525508	FCR377A
RENAULT TRUCKS	5010525041	EFR7661	RENAULT TRUCKS	5010525527	EFR7668
RENAULT TRUCKS	5010525042	EFR7660	RENAULT TRUCKS	5010525528	EFR7669
RENAULT TRUCKS	5010525043	EFR7661	RENAULT TRUCKS	5010525546	EFR7668
RENAULT TRUCKS	5010525044	EFR7658	RENAULT TRUCKS	5010525547	EFR7669
RENAULT TRUCKS	5010525045	EFR7659	RENAULT TRUCKS	5010556274	EFR7673
RENAULT TRUCKS	5010525046	EFR7658	RENAULT TRUCKS	5010598303	09.9492.20
RENAULT TRUCKS	5010525047	EFR7659	RENAULT TRUCKS	5010598303	93192600
RENAULT TRUCKS	5010525283	EFR7610	RENAULT TRUCKS	5010598303	DF50001
RENAULT TRUCKS	5010525284	EFR7611	RENAULT TRUCKS	5010598303	FCR218A
RENAULT TRUCKS	5010525308	09.9492.20	RENAULT TRUCKS	5010598304	09.9493.20
RENAULT TRUCKS	5010525308	93192600	RENAULT TRUCKS	5010598304	DF50003

Les correspondances de références ont pour seul objectif d'aider la recherche de référence

Cross references are there for the sole purpose of helping the reference search

CORRESPONDANCES DES REFERENCES CROSS REFERENCE LIST

MARQUE/MAKER	REF/PN OES	REF/PN	MARQUE/MAKER	REF/PN OES	REF/PN
RENAULT TRUCKS	5010598305	09.9494.40	RENAULT TRUCKS	5021171533	EFR6312
RENAULT TRUCKS	5010598305	93222700	RENAULT TRUCKS	5021171534	EFR7300
RENAULT TRUCKS	5010598305	DF60002	RENAULT TRUCKS	5021171535	EFR7301
RENAULT TRUCKS	5010598305	FCR324A	RENAULT TRUCKS	5021171545	CAC007
RENAULT TRUCKS	5010598306	09.9495.40	RENAULT TRUCKS	5021171545	CAC042
RENAULT TRUCKS	5010598306	93192300	RENAULT TRUCKS	5021175310	EFR6302
RENAULT TRUCKS	5010598306	DF60001	RENAULT TRUCKS	5021175311	EFR6303
RENAULT TRUCKS	5010598306	FCR325A	RENAULT TRUCKS	5021175312	EFR7315
RENAULT TRUCKS	5010598307	09.9496.10	RENAULT TRUCKS	5021175313	EFR7314
RENAULT TRUCKS	5010598307	93192500	RENAULT TRUCKS	5021175314	EFR7317
RENAULT TRUCKS	5010598307	FCR378A	RENAULT TRUCKS	5021175315	EFR7307
RENAULT TRUCKS	5010598308	09.9497.10	RENAULT TRUCKS	5021175316	EFR7301
RENAULT TRUCKS	5010598308	FCR374A	RENAULT TRUCKS	5021175317	EFR7300
RENAULT TRUCKS	5010598309	09.9498.10	RENAULT TRUCKS	5021175318	EFR7303
RENAULT TRUCKS	5010598309	FCR375A	RENAULT TRUCKS	5021175319	EFR7302
RENAULT TRUCKS	5010598356	EFR6200	RENAULT TRUCKS	5021175321	EFR7310
RENAULT TRUCKS	5010598372	2918100604	RENAULT TRUCKS	5021175322	EFR7310
RENAULT TRUCKS	5010598372	2918101	RENAULT TRUCKS	5021175329	EFR7305
RENAULT TRUCKS	5010598376	EFR5000	RENAULT TRUCKS	5021175330	EFR7304
RENAULT TRUCKS	5010598377	EFR5001	RENAULT TRUCKS	5021175410	EFR7304
RENAULT TRUCKS	5010598378	EFR5000	RENAULT TRUCKS	5021179952	CAC011
RENAULT TRUCKS	5010598379	EFR5001	RENAULT TRUCKS	5021179954	EFR7630
RENAULT TRUCKS	5010598422	EFR6200	RENAULT TRUCKS	5021179955	EFR7631
RENAULT TRUCKS	5010598423	EFR6200	RENAULT TRUCKS	5021179956	EFR7692
RENAULT TRUCKS	5010598443	EFR6200	RENAULT TRUCKS	5021179957	EFR7693
RENAULT TRUCKS	5010598640	EFR6008	RENAULT TRUCKS	5021179958	EFR7616
RENAULT TRUCKS	5010622369	EFR7660	RENAULT TRUCKS	5021179959	EFR7617
RENAULT TRUCKS	5010622370	EFR7661	RENAULT TRUCKS	5021201106	EFR7668
RENAULT TRUCKS	5010848607	2928503	RENAULT TRUCKS	5021202776	CAC013
RENAULT TRUCKS	5010848607	CVP032K	RENAULT TRUCKS	5021210433	EFR6309
RENAULT TRUCKS	5010898423	EFR6200	RENAULT TRUCKS	5021210434	EFR6308
RENAULT TRUCKS	5021138544	EFR6650	RENAULT TRUCKS	504222950	EFR7672
RENAULT TRUCKS	5021138545	EFR6651	RENAULT TRUCKS	504222951	EFR7673
RENAULT TRUCKS	5021171517	EFR7305	RENAULT TRUCKS	5600210495	09.9493.60
RENAULT TRUCKS	5021171519	EFR7311	RENAULT TRUCKS	5600210495	93192200
RENAULT TRUCKS	5021171520	EFR6300	RENAULT TRUCKS	5600210495	DF50002
RENAULT TRUCKS	5021171521	EFR6301	RENAULT TRUCKS	5600210495	FCR219A
RENAULT TRUCKS	5021171522	EFR5303	RENAULT TRUCKS	68310622	98022800
RENAULT TRUCKS	5021171523	EFR5302	RENAULT TRUCKS	68310622	W0365RT
RENAULT TRUCKS	5021171524	EFR7301	RENAULT TRUCKS	68320902	98022800
RENAULT TRUCKS	5021171525	EFR7300	RENAULT TRUCKS	68320902	W0365RT
RENAULT TRUCKS	5021171526	EFR7309	RENAULT TRUCKS	68321484	98025100
RENAULT TRUCKS	5021171527	EFR7308	RENAULT TRUCKS	68321484	W0226RT1
RENAULT TRUCKS	5021171528	EFR7303	RENAULT TRUCKS	68321585	2910004
RENAULT TRUCKS	5021171529	EFR7302	RENAULT TRUCKS	68325408	98028200
RENAULT TRUCKS	5021171530	EFR6305	RENAULT TRUCKS	68325408	W0355RT1V2
RENAULT TRUCKS	5021171531	EFR6304	RENAULT TRUCKS	68325408	WIK538
RENAULT TRUCKS	5021171532	EFR6313	RENAULT TRUCKS	7420424070	EFR7624

Les correspondances de références ont pour seul objectif d'aider la recherche de référence

Cross references are there for the sole purpose of helping the reference search

CORRESPONDANCES DES REFERENCES CROSS REFERENCE LIST

MARQUE/MAKER	REF/PN OES	REF/PN	MARQUE/MAKER	REF/PN OES	REF/PN
RENAULT TRUCKS	7420424071	EFR7625	RENAULT TRUCKS	7421454874	CAC018
RENAULT TRUCKS	7420424072	EFR7630	RENAULT TRUCKS	7421471917	EFR5000
RENAULT TRUCKS	7420424073	EFR7631	RENAULT TRUCKS	7421471922	EFR5001
RENAULT TRUCKS	7420560415	2917705	RENAULT TRUCKS	7421487655	EFR7677
RENAULT TRUCKS	7420560415	CVP095K	RENAULT TRUCKS	7421487685	EFR7689
RENAULT TRUCKS	7420566571	EFR7678	RENAULT TRUCKS	7421493598	2928501
RENAULT TRUCKS	7420566573	EFR7679	RENAULT TRUCKS	7421493598	2928503
RENAULT TRUCKS	7420566574	EFR7678	RENAULT TRUCKS	7421493598	CVP032K
RENAULT TRUCKS	7420566575	EFR7679	RENAULT TRUCKS	7421496555	2917400604
RENAULT TRUCKS	7420566576	EFR7678	RENAULT TRUCKS	7421496555	2927301
RENAULT TRUCKS	7420566577	EFR7679	RENAULT TRUCKS	7421496555	CVP101K
RENAULT TRUCKS	7420566578	EFR7678	RENAULT TRUCKS	7421496556	2917300604
RENAULT TRUCKS	7420566579	EFR7679	RENAULT TRUCKS	7421496556	2927201
RENAULT TRUCKS	7420566580	EFR7676	RENAULT TRUCKS	7421496556	CVP100K
RENAULT TRUCKS	7420566581	EFR7677	RENAULT TRUCKS	7421496557	2917705
RENAULT TRUCKS	7420566584	EFR7680	RENAULT TRUCKS	7421496557	CVP095K
RENAULT TRUCKS	7420566585	EFR7681	RENAULT TRUCKS	7421538270	2928401
RENAULT TRUCKS	7420566588	EFR7680	RENAULT TRUCKS	7421538270	CVP116K
RENAULT TRUCKS	7420566589	EFR7681	RENAULT TRUCKS	7421571647	93272100
RENAULT TRUCKS	7420566793	EFR6600	RENAULT TRUCKS	7421571647	DF70005
RENAULT TRUCKS	7420566794	EFR6601	RENAULT TRUCKS	7421571647	FCR249A
RENAULT TRUCKS	7420576069	EFR7678	RENAULT TRUCKS	7421575117	93272000
RENAULT TRUCKS	7420576073	EFR7679	RENAULT TRUCKS	7421575117	DF70010
RENAULT TRUCKS	7420576257	EFR7678	RENAULT TRUCKS	7421575117	FCR259A
RENAULT TRUCKS	7420763264	EFR7668	RENAULT TRUCKS	7421743307	EFR5012
RENAULT TRUCKS	7420763265	EFR7669	RENAULT TRUCKS	7421743594	EFR5013
RENAULT TRUCKS	7420763267	EFR7668	RENAULT TRUCKS	7421750026	EFR6014
RENAULT TRUCKS	7420763268	EFR7669	RENAULT TRUCKS	7421750027	EFR6015
RENAULT TRUCKS	7420763303	EFR7668	RENAULT TRUCKS	7421769571	EFR5010
RENAULT TRUCKS	7420763304	EFR7669	RENAULT TRUCKS	7421769583	EFR5011
RENAULT TRUCKS	7420898067	EFR6003	RENAULT TRUCKS	7421769710	EFR6012
RENAULT TRUCKS	7421074320	EFR5000	RENAULT TRUCKS	7421769782	EFR6013
RENAULT TRUCKS	7421074323	EFR5001	RENAULT TRUCKS	7421866443	09.9493.60
RENAULT TRUCKS	7421399915	2917300604	RENAULT TRUCKS	7421866443	93192200
RENAULT TRUCKS	7421399915	2917303	RENAULT TRUCKS	7421866443	DF50002
RENAULT TRUCKS	7421399915	CVP100K	RENAULT TRUCKS	7421866443	FCR219A
RENAULT TRUCKS	7421399929	2917400604	RENAULT TRUCKS	7421866446	09.9493.60
RENAULT TRUCKS	7421399929	2917403	RENAULT TRUCKS	7421866446	93192200
RENAULT TRUCKS	7421399929	CVP101K	RENAULT TRUCKS	7421866446	DF50002
RENAULT TRUCKS	7421444168	EFR6008	RENAULT TRUCKS	7421866446	FCR219A
RENAULT TRUCKS	7421448982	EFR6008	RENAULT TRUCKS	7421867375	09.B845.20
RENAULT TRUCKS	7421448986	EFR6009	RENAULT TRUCKS	7421867375	93192400
RENAULT TRUCKS	7421448987	EFR6004	RENAULT TRUCKS	7421867375	FCR242A
RENAULT TRUCKS	7421448988	EFR6005	RENAULT TRUCKS	7422537549	EFR6008
RENAULT TRUCKS	7421454169	EFR6002	RENAULT TRUCKS	7422537550	EFR6009
RENAULT TRUCKS	7421454170	EFR6003	RENAULT TRUCKS	7422921057	2917400604
RENAULT TRUCKS	7421454869	EFR6002	RENAULT TRUCKS	7422921057	2917401
RENAULT TRUCKS	7421454870	EFR6003	RENAULT TRUCKS	7422921057	CVP101K

Les correspondances de références ont pour seul objectif d'aider la recherche de référence

Cross references are there for the sole purpose of helping the reference search

CORRESPONDANCES DES REFERENCES CROSS REFERENCE LIST

MARQUE/MAKER	REF/PN OES	REF/PN	MARQUE/MAKER	REF/PN OES	REF/PN
RENAULT TRUCKS	7422921058	2917300604	ROR	15224835T400	CVP024K
RENAULT TRUCKS	7422921058	2917303	ROR	2114543	2921101
RENAULT TRUCKS	7422921058	CVP100K	ROR	21224263	93127900
RENAULT TRUCKS	7422921064	2917400604	ROR	21225115	09.7957.10
RENAULT TRUCKS	7422921064	2927301	ROR	21225115	93117700
RENAULT TRUCKS	7422921064	CVP101K	ROR	21227349	09.8979.10
RENAULT TRUCKS	7422921065	2917300604	ROR	21227349	93117700
RENAULT TRUCKS	7422921065	2917303	ROR	21227349A	09.8979.10
RENAULT TRUCKS	7422921065	2927201	ROR	21227349A	93117700
RENAULT TRUCKS	7422921065	CVP100K	ROR	31788700100	09.7957.10
RENAULT TRUCKS	7422921066	2917705	ROR	31788700100	93117700
RENAULT TRUCKS	7422921066	CVP095K	ROR	906245	2921101
RENAULT TRUCKS	7423149533	2917400604	ROR	DSB2A	2912405
RENAULT TRUCKS	7423149533	2917401	ROR	DSB2A	CVP024K
RENAULT TRUCKS	7423149533	CVP101K	SAE	9291063	2914302
RENAULT TRUCKS	7423814357	09.6732.20	SAE	9291072	FCV4420B
RENAULT TRUCKS	7423814357	93085900	SAE	9317202	2927802
RENAULT TRUCKS	7423814357	FCR126A	SAE-SMB	9317202	2920200604
RENAULT TRUCKS	7424991511	CAC025	SAF	03008001000	EFR7300
RENAULT TRUCKS	7482194787	09.A779.20	SAF	03057000600	2931801
RENAULT TRUCKS	7482421131	09.9495.40	SAF	03057000600	FCV4725PTS
RENAULT TRUCKS	7482421131	93192300	SAF	03057001400	29xxxxx
RENAULT TRUCKS	7482421131	DF60001	SAF	03057001500	FCV4420B
RENAULT TRUCKS	7482421131	FCR325A	SAF	03057007700	2925305390
RENAULT TRUCKS	7485003096	EFR5000	SAF	03057007700	2927801
RENAULT TRUCKS	7485003097	EFR5001	SAF	03057007701	2925305390
RENAULT TRUCKS	7485003098	EFR6002	SAF	03057007701	2927801
RENAULT TRUCKS	7485003099	EFR6003	SAF	03057007800	CVP036K
RENAULT TRUCKS	7485003916	EFR6200	SAF	03057007801	CVP036K
RENAULT TRUCKS	7485013016	EFR7678	SAF	03057007900	2925305390
RENAULT TRUCKS	7485013017	EFR7679	SAF	03057007900	2927801
RENAULT TRUCKS	7485020509	EFR6015	SAF	03057008000	2931302
RENAULT TRUCKS	7485020596	EFR7677	SAF	03057008001	2931302
RENAULT TRUCKS	7485110419	98028200	SAF	03057008500	2925705390
RENAULT TRUCKS	7485110419	W0355RT1V2	SAF	03057008500	2926900604
RENAULT TRUCKS	7485115047	2904303	SAF	03057008500	2926901
RENAULT TRUCKS	7485137789	29142	SAF	03057008500	FCV4461PTS
RENAULT TRUCKS	7485137789	FCV1389	SAF	03057008501	2925705390
RENAULT TRUCKS	7485137848	2931301	SAF	03057008501	2926900604
RENAULT TRUCKS	7485137861	2928502	SAF	03057008501	2926901
RENAULT TRUCKS	7485137861	CVP032K	SAF	03057008501	FCV4461PTS
ROR	104309	09.8979.10	SAF	03057008502	2926900604
ROR	104309	93117700	SAF	03057008502	2926901
ROR	1522089R	EFR6602	SAF	03057009600	FCV4420B
ROR	1522090R	EFR6603	SAF	03057317900	2914302
ROR	15224835	2912405	SAF	03079001600	DF713816
ROR	15224835	CVP024K	SAF	03079001601	DF713816
ROR	15224835T400	2912405	SAF	03079001651	DF713816

Les correspondances de références ont pour seul objectif d'aider la recherche de référence

Cross references are there for the sole purpose of helping the reference search

CORRESPONDANCES DES REFERENCES CROSS REFERENCE LIST

MARQUE/MAKER	REF/PN OES	REF/PN	MARQUE/MAKER	REF/PN OES	REF/PN
SAF	0308000400	EFR7302	SAF	03080002521	EFR6300
SAF	0308000402	EFR7303	SAF	03080002600	EFR7301
SAF	0308000410	EFR7302	SAF	03080002601	EFR7301
SAF	0308000420	EFR7303	SAF	03080002620	EFR7301
SAF	0308000421	EFR7303	SAF	03080002621	EFR7301
SAF	0308000500	EFR7303	SAF	03080002700	EFR7300
SAF	0308000502	EFR7302	SAF	03080002701	EFR7300
SAF	0308000510	EFR7303	SAF	03080002720	EFR7300
SAF	0308000520	EFR7302	SAF	03080002721	EFR7300
SAF	0308000521	EFR7302	SAF	03080003000	EFR7303
SAF	0308000600	EFR6300	SAF	03080003001	EFR7303
SAF	0308000603	EFR6301	SAF	03080003020	EFR7303
SAF	0308000610	EFR6301	SAF	03080003021	EFR7303
SAF	0308000620	EFR6300	SAF	03080003022	EFR7303
SAF	0308000623	EFR6301	SAF	03080003100	EFR7302
SAF	0308000700	EFR6300	SAF	03080003101	EFR7302
SAF	0308000703	EFR6300	SAF	03080003120	EFR7302
SAF	0308000710	EFR6300	SAF	03080003121	EFR7302
SAF	0308000720	EFR6300	SAF	03080003122	EFR7302
SAF	0308000723	EFR6300	SAF	03080003200	EFR6007
SAF	0308000800	EFR7209	SAF	03080003220	EFR6007
SAF	0308000801	EFR7209	SAF	03080003300	EFR6006
SAF	0308000802	EFR7209	SAF	03080003320	EFR6006
SAF	0308001000	EFR7301	SAF	03080003420	EFR6007
SAF	0308001001	EFR7301	SAF	03080003520	EFR6006
SAF	0308001002	EFR7301	SAF	03080003600	EFR7209
SAF	0308001022	EFR7301	SAF	03080003620	EFR7209
SAF	0308001100	EFR7300	SAF	03080003800	EFR6301
SAF	0308001101	EFR7300	SAF	03080003820	EFR6301
SAF	0308001102	EFR7300	SAF	03080003821	EFR6301
SAF	0308001122	EFR7300	SAF	03080003900	EFR6300
SAF	0308001200	EFR7311	SAF	03080003920	EFR6300
SAF	0308001202	EFR7311	SAF	03080003921	EFR6300
SAF	0308001210	EFR7311	SAF	03080004020	EFR7303
SAF	0308001220	EFR7311	SAF	03080004021	EFR7303
SAF	0308001300	EFR7310	SAF	03080004120	EFR7302
SAF	0308001302	EFR7310	SAF	03080004121	EFR7302
SAF	0308001310	EFR7310	SAF	0308000421	EFR7303
SAF	0308001320	EFR7310	SAF	03080004210	EFR7303
SAF	0308001801	EFR6007	SAF	03080004220	EFR7301
SAF	0308001901	EFR6006	SAF	03080004221	EFR7301
SAF	0308002400	EFR6301	SAF	03080004320	EFR7300
SAF	0308002401	EFR6301	SAF	03080004321	EFR7300
SAF	0308002420	EFR6301	SAF	03080004420	EFR6301
SAF	0308002421	EFR6301	SAF	03080004520	EFR6300
SAF	0308002500	EFR6300	SAF	03080004800	EFR7311
SAF	0308002501	EFR6300	SAF	03080004900	EFR7310
SAF	0308002520	EFR6300	SAF	03080005000	EFR7003

Les correspondances de références ont pour seul objectif d'aider la recherche de référence

Cross references are there for the sole purpose of helping the reference search

CORRESPONDANCES DES REFERENCES CROSS REFERENCE LIST

MARQUE/MAKER	REF/PN OES	REF/PN	MARQUE/MAKER	REF/PN OES	REF/PN
SAF	03080005020	EFR7003	SAF	03080008600	EFR6203
SAF	03080005100	EFR7002	SAF	03080008700	EFR7354
SAF	03080005120	EFR7002	SAF	03080008800	EFR7355
SAF	0308000520	EFR7302	SAF	03404200530	CAC008
SAF	0308000521	EFR7302	SAF	03434380400	CAC008
SAF	03080005210	EFR7302	SAF	03434381200	CAC007
SAF	0308000540	EFR6309	SAF	03434381400	CAC009
SAF	03080005401	EFR6309	SAF	03434381500	CAC026
SAF	03080005402	EFR6309	SAF	03434382000	CAC024
SAF	03080005420	EFR6309	SAF	03434382800	CAC019
SAF	03080005421	EFR6309	SAF	04050000500	EFR7302
SAF	0308000550	EFR6308	SAF	04057439600	FCV4420B
SAF	03080005501	EFR6308	SAF	04079000500	93101800
SAF	03080005502	EFR6308	SAF	04079000501	93101800
SAF	03080005520	EFR6308	SAF	04079000502	93101800
SAF	03080005521	EFR6308	SAF	04079001000	09.E156.10
SAF	03080005600	EFR7209	SAF	04079001000	93193400
SAF	03080005601	EFR7209	SAF	04079001001	09.E156.10
SAF	03080005620	EFR7209	SAF	04079001001	93193400
SAF	03080005621	EFR7209	SAF	04079001002	09.E156.10
SAF	03080005900	EFR6308	SAF	04079001002	93193400
SAF	03080005901	EFR6308	SAF	04079001003	09.E156.10
SAF	03080005902	EFR6308	SAF	04079001003	93193400
SAF	03080005920	EFR6308	SAF	04079001004	09.E156.10
SAF	03080006000	EFR6309	SAF	04079001004	93193400
SAF	03080006001	EFR6309	SAF	04079001300	93193500
SAF	03080006020	EFR6309	SAF	04079001301	93193500
SAF	03080006100	EFR6300	SAF	04079001302	93193500
SAF	03080006120	EFR6300	SAF	04080000400	EFR7303
SAF	03080006200	EFR6301	SAF	04080000420	EFR7303
SAF	03080006220	EFR6301	SAF	04080000500	EFR7302
SAF	03080006300	EFR7302	SAF	04080000520	EFR7302
SAF	03080006320	EFR7302	SAF	04080000600	EFR6301
SAF	03080006400	EFR7303	SAF	04080000601	EFR6301
SAF	03080006420	EFR7303	SAF	04080000602	EFR6301
SAF	03080006900	EFR6308	SAF	04080000603	EFR6301
SAF	03080006950	EFR6308	SAF	04080000700	EFR6300
SAF	03080007000	EFR6309	SAF	04080000701	EFR6300
SAF	03080007050	EFR6309	SAF	04080000702	EFR6300
SAF	03080007900	EFR7310	SAF	04080000703	EFR6300
SAF	03080008000	EFR7311	SAF	04080001000	EFR7301
SAF	03080008100	EFR7206	SAF	04080001002	EFR7301
SAF	03080008101	EFR7206	SAF	04080001100	EFR7300
SAF	03080008200	EFR7207	SAF	04080001102	EFR7300
SAF	03080008201	EFR7207	SAF	04080001200	EFR7311
SAF	03080008300	EFR6301	SAF	04080001202	EFR7311
SAF	03080008400	EFR6300	SAF	04080001300	EFR7310
SAF	03080008500	EFR6202	SAF	04080001302	EFR7310

Les correspondances de références ont pour seul objectif d'aider la recherche de référence

Cross references are there for the sole purpose of helping the reference search

CORRESPONDANCES DES REFERENCES CROSS REFERENCE LIST

MARQUE/MAKER	REF/PN OES	REF/PN	MARQUE/MAKER	REF/PN OES	REF/PN
SAF	04080003200	EFR6007	SAF	3057007701	2920200604
SAF	04080003300	EFR6006	SAF	3057007701	2927801
SAF	04080005000	EFR7003	SAF	3057007701	CVP020K
SAF	04080005100	EFR7002	SAF	3057007800	2932004
SAF	04080005600	EFR7209	SAF	3057007800	CVP036K
SAF	04080500600	EFR7302	SAF	3057007801	2932004
SAF	05317002100	CAC005	SAF	3057007801	CVP036K
SAF	05317002300	2925305390	SAF	3057007900	2914302
SAF	05317002300	2927801	SAF	3057007900	2920200604
SAF	05317002400	CVP036K	SAF	3057007900	2927801
SAF	05317002900	EFR7302	SAF	3057007900	CVP020K
SAF	05317003000	EFR7303	SAF	3057008400	2933601
SAF	05400100100	EFR6302	SAF	3057008401	2933601
SAF	05400100200	EFR6303	SAF	3057317900	2914302
SAF	05400100300	EFR6301	SAF	3079001500	09.E164.20
SAF	05400100400	EFR6300	SAF	3079001501	09.E164.20
SAF	05400100500	EFR7303	SAF	3080000402	EFR7303
SAF	05400100600	EFR7302	SAF	3080000410	EFR7302
SAF	05400100700	EFR7301	SAF	3080000420	EFR7303
SAF	05400100800	EFR7300	SAF	3080000421	EFR7303
SAF	05400100900	EFR7311	SAF	3080000502	EFR7302
SAF	05400101000	EFR7310	SAF	3080000510	EFR7303
SAF	05400101100	EFR6308	SAF	3080000520	EFR7302
SAF	05400101200	EFR6309	SAF	3080000521	EFR7302
SAF	084080000400	EFR7303	SAF	3080000600	EFR6300
SAF	084080000402	EFR7303	SAF	3080000600	EFR6301
SAF	084080000421	EFR7303	SAF	3080000603	EFR6301
SAF	084080000500	EFR7302	SAF	3080000610	EFR6301
SAF	084080000502	EFR7302	SAF	3080000620	EFR6300
SAF	084080000521	EFR7302	SAF	3080000620	EFR6301
SAF	084080000600	EFR6301	SAF	3080000623	EFR6301
SAF	084080000601	EFR6301	SAF	3080000700	EFR6300
SAF	084080000603	EFR6301	SAF	3080000700	EFR6301
SAF	084080000623	EFR6301	SAF	3080000703	EFR6300
SAF	084080000700	EFR6300	SAF	3080000710	EFR6300
SAF	084080000701	EFR6300	SAF	3080000720	EFR6300
SAF	084080000703	EFR6300	SAF	3080000720	EFR6301
SAF	084080000723	EFR6300	SAF	3080000723	EFR6300
SAF	085317002100	CAC005	SAF	3080001000	EFR7301
SAF	085317002900	EFR7302	SAF	3080001001	EFR7301
SAF	085317003000	EFR7303	SAF	3080001022	EFR7301
SAF	1079000400	09.8367.10	SAF	3080001100	EFR7300
SAF	1079000400	93101700	SAF	3080001101	EFR7300
SAF	1079000400	FCR202A	SAF	3080001122	EFR7300
SAF	233501309	2933601	SAF	3080001200	EFR7311
SAF	3057007700	2920200604	SAF	3080001202	EFR7311
SAF	3057007700	2927801	SAF	3080001210	EFR7311
SAF	3057007700	CVP020K	SAF	3080001220	EFR7311

Les correspondances de références ont pour seul objectif d'aider la recherche de référence

Cross references are there for the sole purpose of helping the reference search

CORRESPONDANCES DES REFERENCES CROSS REFERENCE LIST

MARQUE/MAKER	REF/PN OES	REF/PN	MARQUE/MAKER	REF/PN OES	REF/PN
SAF	3080001300	EFR7310	SAF	3080004210	EFR7303
SAF	3080001302	EFR7310	SAF	3080004220	EFR7301
SAF	3080001310	EFR7310	SAF	3080004221	EFR7301
SAF	3080001320	EFR7310	SAF	3080004320	EFR7300
SAF	3080001801	EFR6007	SAF	3080004321	EFR7300
SAF	3080001901	EFR6006	SAF	3080004420	EFR6301
SAF	3080002400	EFR6301	SAF	3080004520	EFR6300
SAF	3080002420	EFR6301	SAF	3080004820	EFR7311
SAF	3080002421	EFR6301	SAF	3080004920	EFR7310
SAF	3080002500	EFR6300	SAF	3080005000	EFR7003
SAF	3080002520	EFR6300	SAF	308000502	EFR7003
SAF	3080002521	EFR6300	SAF	3080005020	EFR7003
SAF	3080002600	EFR7301	SAF	3080005100	EFR7002
SAF	3080002620	EFR7301	SAF	308000512	EFR7002
SAF	3080002621	EFR7301	SAF	3080005120	EFR7002
SAF	3080002700	EFR7300	SAF	3080005210	EFR7302
SAF	3080002720	EFR7300	SAF	308000540	EFR6309
SAF	3080002721	EFR7300	SAF	3080005420	EFR6309
SAF	3080003000	EFR7303	SAF	3080005421	EFR6309
SAF	3080003001	EFR7303	SAF	308000550	EFR6308
SAF	3080003020	EFR7303	SAF	3080005520	EFR6308
SAF	3080003021	EFR7303	SAF	3080005521	EFR6308
SAF	3080003022	EFR7303	SAF	3080005900	EFR6308
SAF	3080003100	EFR7302	SAF	3080005920	EFR6308
SAF	3080003101	EFR7302	SAF	3080006000	EFR6309
SAF	3080003120	EFR7302	SAF	3080006020	EFR6309
SAF	3080003121	EFR7302	SAF	3080006100	EFR6300
SAF	3080003122	EFR7302	SAF	3080006120	EFR6300
SAF	3080003200	EFR6007	SAF	3080006200	EFR6301
SAF	308000322	EFR6007	SAF	3080006220	EFR6301
SAF	3080003220	EFR6007	SAF	3080006320	EFR7302
SAF	3080003300	EFR6006	SAF	3080006420	EFR7303
SAF	308000332	EFR6006	SAF	3080006700	EFR7008
SAF	3080003320	EFR6006	SAF	3080006720	EFR7008
SAF	308000342	EFR6007	SAF	3080006800	EFR7009
SAF	3080003420	EFR6007	SAF	3080006820	EFR7009
SAF	308000352	EFR6006	SAF	3080006950	EFR6308
SAF	3080003520	EFR6006	SAF	3080007050	EFR6309
SAF	3080003800	EFR6301	SAF	3080007101	EFR6010
SAF	3080003820	EFR6301	SAF	3080007121	EFR6010
SAF	3080003821	EFR6301	SAF	3080007151	EFR6010
SAF	3080003900	EFR6300	SAF	3080007201	EFR6011
SAF	3080003920	EFR6300	SAF	3080007221	EFR6011
SAF	3080003921	EFR6300	SAF	3080007251	EFR6011
SAF	3080004020	EFR7303	SAF	3424200100	W0760SA
SAF	3080004021	EFR7303	SAF	3424203300	W0610SA
SAF	3080004120	EFR7302	SAF	3434380500	CAC010
SAF	3080004121	EFR7302	SAF	3434382000	CAC042

Les correspondances de références ont pour seul objectif d'aider la recherche de référence

Cross references are there for the sole purpose of helping the reference search

CORRESPONDANCES DES REFERENCES CROSS REFERENCE LIST

MARQUE/MAKER	REF/PN OES	REF/PN	MARQUE/MAKER	REF/PN OES	REF/PN
SAF	3434382300	CAC043	SAF	4079001700	FCR358A
SAF	4057427700	2920200604	SAF	4079001701	09.E162.10
SAF	4057427700	2927801	SAF	4079001701	93308700
SAF	4079000300	09.8368.10	SAF	4079001701	FCR358A
SAF	4079000300	93101900	SAF	4079001751	09.E162.10
SAF	4079000300	FCR203A	SAF	4079001751	93308700
SAF	4079000301	09.8368.10	SAF	4079001751	FCR358A
SAF	4079000301	93101900	SAF	4079001800	09.E163.10
SAF	4079000301	FCR203A	SAF	4079001800	FCR373A
SAF	4079000400	09.8367.10	SAF	4079001801	09.E163.10
SAF	4079000400	93101700	SAF	4079001801	FCR373A
SAF	4079000400	FCR202A	SAF	4079001851	09.E163.10
SAF	4079000401	09.8367.10	SAF	4079001851	FCR373A
SAF	4079000401	93101700	SAF	4080000400	EFR7303
SAF	4079000401	FCR202A	SAF	4080000420	EFR7303
SAF	4079000500	09.8793.10	SAF	4080000500	EFR7302
SAF	4079000500	93101800	SAF	4080000520	EFR7302
SAF	4079000500	FCR201A	SAF	4080000600	EFR6301
SAF	4079000501	09.8793.10	SAF	4080000601	EFR6301
SAF	4079000501	93101800	SAF	4080000602	EFR6301
SAF	4079000501	FCR201A	SAF	4080000603	EFR6301
SAF	4079000502	09.8793.10	SAF	4080000700	EFR6300
SAF	4079000502	93101800	SAF	4080000701	EFR6300
SAF	4079000502	FCR201A	SAF	4080000702	EFR6300
SAF	4079000700	09.8556.10	SAF	4080000703	EFR6300
SAF	4079000700	93105600	SAF	4080001000	EFR7301
SAF	4079000700	FCR204A	SAF	4080001002	EFR7301
SAF	4079000701	09.8556.10	SAF	4080001100	EFR7300
SAF	4079000701	93105600	SAF	4080001102	EFR7300
SAF	4079000701	FCR204A	SAF	4080001200	EFR7311
SAF	4079000701A	09.8556.10	SAF	4080001202	EFR7311
SAF	4079000701A	93105600	SAF	4080001300	EFR7310
SAF	4079000701A	FCR204A	SAF	4080001302	EFR7310
SAF	4079000702	09.8556.10	SAF	4080003200	EFR6007
SAF	4079000702	93105600	SAF	4080003300	EFR6006
SAF	4079000702	FCR204A	SAF	4080005000	EFR7003
SAF	4079000703	09.8556.10	SAF	4080005100	EFR7002
SAF	4079000703	93105600	SAF	5317002300	2920200604
SAF	4079000703	FCR204A	SAF	5317002300	2927801
SAF	4079001300	09.E155.10	SAF	5317002300	CVP020K
SAF	4079001301	09.E155.10	SAF	5317002400	2932004
SAF	4079001302	09.E155.10	SAF	5317002400	CVP036K
SAF	4079001303	09.E155.10	SAF	5317002900	EFR7302
SAF	4079001304	09.E155.10	SAF	5317003000	EFR7303
SAF	4079001500	09.E164.20	SAF	84080000400	EFR7303
SAF	4079001501	09.E164.20	SAF	84080000421	EFR7303
SAF	4079001700	09.E162.10	SAF	84080000500	EFR7302
SAF	4079001700	93308700	SAF	84080000521	EFR7302

Les correspondances de références ont pour seul objectif d'aider la recherche de référence

Cross references are there for the sole purpose of helping the reference search

CORRESPONDANCES DES REFERENCES CROSS REFERENCE LIST

MARQUE/MAKER	REF/PN OES	REF/PN	MARQUE/MAKER	REF/PN OES	REF/PN
SAF	8408000600	EFR6301	SCANIA	1395179	EFR7325
SAF	8408000601	EFR6301	SCANIA	1402272	09.A995.10
SAF	8408000603	EFR6301	SCANIA	1402272	93088300
SAF	8408000623	EFR6301	SCANIA	1402272	DF70003
SAF	8408000700	EFR6300	SCANIA	1402272	FCR170A
SAF	8408000701	EFR6300	SCANIA	1415147	09.B325.40
SAF	8408000703	EFR6300	SCANIA	1415147	93086800
SAF	8408000723	EFR6300	SCANIA	1415147	FCR168A
SAF	8443437100	CAC010	SCANIA	1415149	CAC005
SAF	85317002900	EFR7302	SCANIA	1422033	EFR7310
SAF	85317003000	EFR7303	SCANIA	1422034	EFR7311
SAF	Z0008242	W0940SABP	SCANIA	1422035	EFR7324
SAMRO	2100247	EFR7668	SCANIA	1422036	EFR7325
SAMRO	2100248	EFR7669	SCANIA	1426662	EFR7314
SCANIA	1134898	EFR7314	SCANIA	1426663	EFR7315
SCANIA	1134899	EFR7315	SCANIA	1444207	CAC005
SCANIA	1137392	EFR7310	SCANIA	1444855	EFR7321
SCANIA	1137393	EFR7311	SCANIA	1444856	EFR7320
SCANIA	1363748	EFR7303	SCANIA	1446730	EFR7303
SCANIA	1363749	EFR7302	SCANIA	1446731	EFR7302
SCANIA	1365719	EFR7310	SCANIA	1450416	EFR7306
SCANIA	1365720	EFR7311	SCANIA	1450417	EFR7307
SCANIA	1367735	09.A995.10	SCANIA	1472419	EFR7311
SCANIA	1367735	93088300	SCANIA	1472420	EFR7310
SCANIA	1367735	DF70003	SCANIA	1472919	CAC010
SCANIA	1367735	FCR170A	SCANIA	1472919	CAC042
SCANIA	1386686	09.A995.10	SCANIA	1473364	EFR7302
SCANIA	1386686	93088300	SCANIA	1473365	EFR7303
SCANIA	1386686	DF70003	SCANIA	1473366	EFR7302
SCANIA	1386686	FCR170A	SCANIA	1473367	EFR7303
SCANIA	1388610	EFR7306	SCANIA	1477675	CAC010
SCANIA	1388611	EFR7307	SCANIA	1480809	EFR7325
SCANIA	1388953	98025400	SCANIA	1480810	EFR7324
SCANIA	1388953	W0310SV4	SCANIA	1480811	EFR7307
SCANIA	1390426	CAC005	SCANIA	1480812	EFR7306
SCANIA	1390427	CAC005	SCANIA	1483309	EFR7315
SCANIA	1390428	2920200604	SCANIA	1483310	EFR7314
SCANIA	1390428	2925305390	SCANIA	1502046	W0310SV4
SCANIA	1390428	2927801	SCANIA	1504808	CAC042
SCANIA	1390428	2927802	SCANIA	1511581	EFR7303
SCANIA	1390428	2933100604	SCANIA	1511582	EFR7302
SCANIA	1390428	2933101	SCANIA	1513588	EFR7320
SCANIA	1390428	2933102	SCANIA	1513589	EFR7321
SCANIA	1390428	CVP020K	SCANIA	1513590	EFR7302
SCANIA	1390429	CAC008	SCANIA	1513591	EFR7303
SCANIA	1390431	EFR7310	SCANIA	1513592	EFR7335
SCANIA	1390432	EFR7311	SCANIA	1513593	EFR7334
SCANIA	1395178	EFR7324	SCANIA	1513594	EFR7306

Les correspondances de références ont pour seul objectif d'aider la recherche de référence

Cross references are there for the sole purpose of helping the reference search

CORRESPONDANCES DES REFERENCES CROSS REFERENCE LIST

MARQUE/MAKER	REF/PN OES	REF/PN	MARQUE/MAKER	REF/PN OES	REF/PN
SCANIA	1513595	EFR7307	SCANIA	1740403	EFR7307
SCANIA	1517003	EFR7303	SCANIA	1740404	EFR7306
SCANIA	1517004	EFR7302	SCANIA	1740405	EFR7307
SCANIA	1517005	EFR7307	SCANIA	1743421	CAC008
SCANIA	1517006	EFR7306	SCANIA	1743421	CAC009
SCANIA	1521979	2920200604	SCANIA	1744249	EFR7321
SCANIA	1521979	2925305390	SCANIA	1744250	EFR7320
SCANIA	1521979	2927801	SCANIA	1744251	EFR7303
SCANIA	1521979	2927802	SCANIA	1744252	EFR7302
SCANIA	1521979	2933100604	SCANIA	1744253	EFR7303
SCANIA	1521979	2933101	SCANIA	1744254	EFR7302
SCANIA	1521979	2933102	SCANIA	1744255	EFR7303
SCANIA	1521979	CVP020K	SCANIA	1744256	EFR7302
SCANIA	1527633	2920200604	SCANIA	1744258	EFR7335
SCANIA	1527633	2925305390	SCANIA	1744259	EFR7334
SCANIA	1527633	2927801	SCANIA	1744260	EFR7306
SCANIA	1527633	2933100604	SCANIA	1744261	EFR7307
SCANIA	1527633	2933101	SCANIA	1744262	EFR7306
SCANIA	1527633	CVP020K	SCANIA	1744263	EFR7307
SCANIA	1689313	CAC009	SCANIA	1745465	EFR7307
SCANIA	1723416	CAC007	SCANIA	1745466	EFR7306
SCANIA	1731222	EFR7314	SCANIA	1746796	EFR7320
SCANIA	1731223	EFR7315	SCANIA	1746797	EFR7321
SCANIA	1731224	EFR7302	SCANIA	1746798	EFR7334
SCANIA	1731225	EFR7303	SCANIA	1746799	EFR7335
SCANIA	1731226	EFR7320	SCANIA	1746824	CAC008
SCANIA	1731227	EFR7321	SCANIA	1756384	EFR7320
SCANIA	1731228	EFR7335	SCANIA	1756385	EFR7321
SCANIA	1731229	EFR7334	SCANIA	1756386	EFR7302
SCANIA	1734521	EFR7321	SCANIA	1756387	EFR7303
SCANIA	1734522	EFR7320	SCANIA	1756389	CAC008
SCANIA	1734523	EFR7303	SCANIA	1756394	EFR7335
SCANIA	1734524	EFR7302	SCANIA	1756395	EFR7334
SCANIA	1734525	EFR7303	SCANIA	1756396	EFR7306
SCANIA	1734526	EFR7302	SCANIA	1756397	EFR7307
SCANIA	1734527	EFR7334	SCANIA	17566389	CAC009
SCANIA	1734528	EFR7335	SCANIA	1757010	EFR7314
SCANIA	1734529	2920200604	SCANIA	1757011	EFR7315
SCANIA	1734529	2925305390	SCANIA	1757012	EFR7323
SCANIA	1734529	2927801	SCANIA	1757013	EFR7322
SCANIA	1734529	2927802	SCANIA	1759811	CAC008
SCANIA	1734529	2933100604	SCANIA	1798063	CAC005
SCANIA	1734529	2933101	SCANIA	1852817	09.A995.10
SCANIA	1734529	2933102	SCANIA	1852817	93088300
SCANIA	1734529	CVP020K	SCANIA	1852817	DF70003
SCANIA	1740400	EFR7302	SCANIA	1852817	FCR170A
SCANIA	1740401	EFR7303	SCANIA	185608	2920200604
SCANIA	1740402	EFR7306	SCANIA	185608	2927801

Les correspondances de références ont pour seul objectif d'aider la recherche de référence

Cross references are there for the sole purpose of helping the reference search

CORRESPONDANCES DES REFERENCES CROSS REFERENCE LIST

MARQUE/MAKER	REF/PN OES	REF/PN	MARQUE/MAKER	REF/PN OES	REF/PN
SCANIA	185608	2927802	SCANIA	1921153	EFR7307
SCANIA	185608	CVP020K	SCANIA	1921154	EFR7322
SCANIA	1856108	2920200604	SCANIA	1921155	EFR7302
SCANIA	1856108	2925305390	SCANIA	1921156	EFR7303
SCANIA	1856108	2927801	SCANIA	1921157	EFR7321
SCANIA	1856108	2927802	SCANIA	1921158	EFR7320
SCANIA	1856108	2933100604	SCANIA	1928812	EFR7320
SCANIA	1856108	2933101	SCANIA	1928813	EFR7321
SCANIA	1856108	2933102	SCANIA	1928820	EFR7321
SCANIA	1856108	CVP020K	SCANIA	1928821	EFR7320
SCANIA	1889543	09.A995.10	SCANIA	1946306	EFR7320
SCANIA	1889543	93088300	SCANIA	1946307	EFR7321
SCANIA	1889543	DF70003	SCANIA	1946308	EFR7320
SCANIA	1889543	FCR170A	SCANIA	1946309	EFR7321
SCANIA	1890860	2920200604	SCANIA	1946324	EFR7302
SCANIA	1890860	2927802	SCANIA	1946325	EFR7303
SCANIA	1890860	2933100604	SCANIA	1946326	EFR7321
SCANIA	1890860	2933102	SCANIA	1946327	EFR7320
SCANIA	1890860	CVP020K	SCANIA	20190319	2933200604
SCANIA	1890861	2920200604	SCANIA	20190319	2933201
SCANIA	1890861	2927801	SCANIA	20190319	29332FLE1749
SCANIA	1890861	2927802	SCANIA	2087143	CAC042
SCANIA	1890861	2933100604	SCANIA	2093073	EFR6006
SCANIA	1890861	2933101	SCANIA	2093075	EFR6007
SCANIA	1890861	CVP020K	SCANIA	2093076	EFR7002
SCANIA	1903071	EFR7321	SCANIA	2093077	EFR7003
SCANIA	1903072	EFR7320	SCANIA	2121646	CAC025
SCANIA	1903079	EFR7320	SCANIA	2121647	CAC026
SCANIA	1903080	EFR7321	SCANIA	2127745	2933200604
SCANIA	1903435	EFR7335	SCANIA	2127745	2933201
SCANIA	1903436	EFR7334	SCANIA	2127745	29332FLE1749
SCANIA	1903441	EFR7334	SCANIA	2206045	EFR7203
SCANIA	1903442	EFR7335	SCANIA	2206046	EFR7202
SCANIA	1903445	EFR7322	SCANIA	2206048	EFR7204
SCANIA	1903446	EFR7323	SCANIA	2254728	EFR7328
SCANIA	1913986	EFR7320	SCANIA	2254731	EFR7329
SCANIA	1913987	EFR7321	SCANIA	2254739	EFR6300
SCANIA	1913999	EFR7334	SCANIA	2264183	EFR7321
SCANIA	1914000	EFR7335	SCANIA	2264206	EFR7320
SCANIA	1914100	2920200604	SCANIA	2264208	EFR7321
SCANIA	1914100	2927802	SCANIA	2264211	EFR7335
SCANIA	1914100	2933100604	SCANIA	2264224	EFR7334
SCANIA	1914100	2933102	SCANIA	2264228	EFR7334
SCANIA	1914100	CVP020K	SCANIA	2264230	EFR7335
SCANIA	1921149	EFR7323	SCANIA	2264275	EFR7320
SCANIA	1921150	EFR7335	SCANIA	2271804	2933100604
SCANIA	1921151	EFR7334	SCANIA	2271804	2933101
SCANIA	1921152	EFR7306	SCANIA	2272502	2933200604

Les correspondances de références ont pour seul objectif d'aider la recherche de référence

Cross references are there for the sole purpose of helping the reference search

CORRESPONDANCES DES REFERENCES CROSS REFERENCE LIST

MARQUE/MAKER	REF/PN OES	REF/PN	MARQUE/MAKER	REF/PN OES	REF/PN
SCANIA	2272502	2933201	SCANIA	573099	EFR7314
SCANIA	2272502	29332FLE1749	SCANIA	573100	EFR7315
SCANIA	2272503	2933200604	SCANIA	725857	2914302
SCANIA	2272503	2933201	SCANIA	SP1037016	EFR7301
SCANIA	2272503	29332FLE1749	SCANIA	SP1037038	EFR6302
SCANIA	2292232	CAC042	SCANIA	SP1037039	EFR6303
SCANIA	2325212	2933100604	SCANIA	SP1037041	EFR7303
SCANIA	2325212	2933101	SCANIA	SP1037042	EFR7302
SCANIA	2325213	2933100604	SCANIA	SP1037045	EFR7303
SCANIA	2325213	2933102	SCANIA	SP1037050	EFR6308
SCANIA	2352212	2933100604	SCANIA	SP1037051	EFR7300
SCANIA	2352212	2933101	SCANIA	SP1037052	EFR7301
SCANIA	2365038	CAC042	SCANIA	SP1037059	EFR7300
SCANIA	2395623	EFR7335	SCANIA	SP1037060	EFR6301
SCANIA	2395624	EFR7334	SCANIA	SP1037073	EFR6300
SCANIA	2395647	EFR7323	SCANIA	SP1037074	EFR6309
SCANIA	2395648	EFR7322	SCANIA	SP1037075	EFR7329
SCANIA	2419194	EFR7314	SCANIA	SP1037076	EFR7328
SCANIA	2419195	EFR7315	SCANIA	SP1037084	EFR6306
SCANIA	2568026	2933100604	SCANIA	SP1037085	EFR6307
SCANIA	2568026	2933102	SCANIA	SP1037091	EFR6301
SCANIA	2920101	2927801	SCANIA	SP1037092	EFR6300
SCANIA	570937	EFR6650	SCANIA	SP1037118	EFR7302
SCANIA	570938	EFR6651	SCANIA	SP1037132	EFR7304
SCANIA	570939	EFR7692	SCANIA	SP1037133	EFR7305
SCANIA	570941	EFR7693	SCHAEFFLER	21701210	CAC006
SCANIA	570942	EFR7616	SCHMITZ	015348	EFR7300
SCANIA	570943	EFR7617	SCHMITZ	015349	EFR7301
SCANIA	570946	EFR6602	SCHMITZ	015738	EFR7303
SCANIA	570947	EFR6603	SCHMITZ	015739	EFR7302
SCANIA	570948	EFR7704	SCHMITZ	016013	EFR6301
SCANIA	570949	EFR7705	SCHMITZ	016278	EFR7301
SCANIA	571143	EFR7314	SCHMITZ	016279	EFR7300
SCANIA	571144	EFR7315	SCHMITZ	017257	EFR6301
SCANIA	571158	EFR7314	SCHMITZ	017258	EFR6300
SCANIA	571159	EFR7315	SCHMITZ	017259	EFR7300
SCANIA	571160	EFR7320	SCHMITZ	017260	EFR7301
SCANIA	571161	EFR7321	SCHMITZ	017645	EFR7300
SCANIA	571162	EFR7324	SCHMITZ	017646	EFR7301
SCANIA	571163	EFR7325	SCHMITZ	017870	09.9406.20
SCANIA	571164	EFR7302	SCHMITZ	017870	FCR336A
SCANIA	571165	EFR7303	SCHMITZ	017938	EFR7301
SCANIA	571796	EFR7311	SCHMITZ	017939	EFR7300
SCANIA	571797	EFR7310	SCHMITZ	0520010006	09.9406.20
SCANIA	571798	EFR7325	SCHMITZ	0520010006	93296100
SCANIA	571799	EFR7324	SCHMITZ	0520010006	FCR336A
SCANIA	572708	EFR6650	SCHMITZ	056793	EFR6308
SCANIA	572709	EFR6651	SCHMITZ	056794	EFR6309

Les correspondances de références ont pour seul objectif d'aider la recherche de référence

Cross references are there for the sole purpose of helping the reference search

CORRESPONDANCES DES REFERENCES CROSS REFERENCE LIST

MARQUE/MAKER	REF/PN OES	REF/PN	MARQUE/MAKER	REF/PN OES	REF/PN
SCHMITZ	1004657	09.8368.10	SCHMITZ	1105072	EFR6301
SCHMITZ	1004657	93101900	SCHMITZ	1105073	EFR6300
SCHMITZ	1004657	FCR203A	SCHMITZ	1105074	EFR7301
SCHMITZ	1006017	EFR6309	SCHMITZ	1105075	EFR7300
SCHMITZ	1006018	EFR6308	SCHMITZ	1105586	CAC026
SCHMITZ	100617	EFR6309	SCHMITZ	1105625	2925705390
SCHMITZ	100618	EFR6308	SCHMITZ	1105625	2926900604
SCHMITZ	1008450	CAC026	SCHMITZ	1105625	2926901
SCHMITZ	1008452	2925705390	SCHMITZ	1105625	FCV4461PTS
SCHMITZ	1008452	2926900604	SCHMITZ	1110435	EFR7002
SCHMITZ	1008452	2926901	SCHMITZ	1110436	EFR7003
SCHMITZ	1008452	FCV4461PTS	SCHMITZ	1122688	EFR6308
SCHMITZ	1009863	09.8368.10	SCHMITZ	1122689	EFR6309
SCHMITZ	1009863	93101900	SCHMITZ	1123373	2932801
SCHMITZ	1009863	FCR203A	SCHMITZ	1123373	FCV4736PTS
SCHMITZ	1011594	EFR7303	SCHMITZ	1161563	2925705390
SCHMITZ	1011595	EFR7302	SCHMITZ	1161563	2926900604
SCHMITZ	1011906	2933601	SCHMITZ	1161563	2926901
SCHMITZ	101449	2933601	SCHMITZ	1161563	FCV4461PTS
SCHMITZ	1020778	EFR6006	SCHMITZ	1172846	EFR6309
SCHMITZ	1020779	EFR6007	SCHMITZ	1176816	09.9406.20
SCHMITZ	1021348	EFR6300	SCHMITZ	1176816	93296100
SCHMITZ	1021349	EFR6301	SCHMITZ	1176816	FCR336A
SCHMITZ	1024008	EFR7300	SCHMITZ	1178243	2932801
SCHMITZ	1024010	EFR7301	SCHMITZ	1178243	FCV4736PTS
SCHMITZ	1063036	EFR7002	SCHMITZ	1182462	2925305390
SCHMITZ	1063037	EFR7003	SCHMITZ	1182462	2927801
SCHMITZ	1068118	2933601	SCHMITZ	1182462	CVP020K
SCHMITZ	1068161	EFR7002	SCHMITZ	1182957	2927801
SCHMITZ	1068162	EFR7003	SCHMITZ	1182957	CVP020K
SCHMITZ	1085803	EFR7302	SCHMITZ	1182958	2932004
SCHMITZ	1085804	EFR7303	SCHMITZ	1182958	CVP036K
SCHMITZ	1088133	09.E403.10	SCHMITZ	1195232	2933606
SCHMITZ	1088133	93308800	SCHMITZ	1227579	CAC043
SCHMITZ	1091853	09.8556.10	SCHMITZ	1227593	EFR7354
SCHMITZ	1091853	93105600	SCHMITZ	1227594	EFR7355
SCHMITZ	1091853	FCR204A	SCHMITZ	1227596	EFR7354
SCHMITZ	1096168	W0760SA	SCHMITZ	1227597	EFR7355
SCHMITZ	1100810	2931302	SCHMITZ	1263757	EFR7300
SCHMITZ	1101449	2933601	SCHMITZ	1263758	EFR7301
SCHMITZ	1104517	W0760SA	SCHMITZ	1268085	EFR6300
SCHMITZ	1105054	EFR6303	SCHMITZ	1268086	EFR6301
SCHMITZ	1105061	EFR7303	SCHMITZ	1282313	EFR7354
SCHMITZ	1105063	EFR7302	SCHMITZ	1282314	EFR7355
SCHMITZ	1105066	EFR7311	SCHMITZ	1282317	CAC043
SCHMITZ	1105067	EFR7310	SCHMITZ	15348	EFR7300
SCHMITZ	1105070	EFR6308	SCHMITZ	15349	EFR7301
SCHMITZ	1105071	EFR6309	SCHMITZ	15738	EFR7303

Les correspondances de références ont pour seul objectif d'aider la recherche de référence

Cross references are there for the sole purpose of helping the reference search

CORRESPONDANCES DES REFERENCES CROSS REFERENCE LIST

MARQUE/MAKER	REF/PN OES	REF/PN	MARQUE/MAKER	REF/PN OES	REF/PN
SCHMITZ	15739	EFR7302	SCHWARZMULLER	117710	EFR5300
SCHMITZ	16013	EFR6301	SCHWARZMULLER	117711	EFR5302
SCHMITZ	16278	EFR7301	SCHWARZMULLER	117712	EFR5304
SCHMITZ	16279	EFR7300	SCHWARZMULLER	117713	EFR5305
SCHMITZ	17160	CAC004	SCHWARZMULLER	117904	EFR6314
SCHMITZ	17251	2920200604	SCHWARZMULLER	46778	EFR6007
SCHMITZ	17251	2925305390	SCHWARZMULLER	46779	EFR6006
SCHMITZ	17251	2927801	SCHWARZMULLER	51239	CAC019
SCHMITZ	17251	CVP020K	SCHWARZMULLER	51452	W0760SA
SCHMITZ	17257	EFR6301	SCHWARZMULLER	62745	EFR7302
SCHMITZ	17258	EFR6300	SCHWARZMULLER	62746	EFR7303
SCHMITZ	17259	EFR7300	SCHWARZMULLER	62747	EFR6300
SCHMITZ	17260	EFR7301	SCHWARZMULLER	62748	EFR6301
SCHMITZ	17478	CAC007	SCHWARZMULLER	62749	EFR7300
SCHMITZ	17478	CAC042	SCHWARZMULLER	62750	EFR7301
SCHMITZ	17645	EFR7300	SCHWARZMULLER	62894	EFR7305
SCHMITZ	17646	EFR7301	SCHWARZMULLER	62895	EFR7304
SCHMITZ	17692	CAC007	SCHWARZMULLER	66493	2933601
SCHMITZ	17899	CAC007	SCHWARZMULLER	74231	EFR6308
SCHMITZ	17927	2920200604	SCHWARZMULLER	74232	EFR6309
SCHMITZ	17927	2927801	SCHWARZMULLER	79821	EFR7002
SCHMITZ	17938	EFR7301	SCHWARZMULLER	79822	EFR7003
SCHMITZ	17939	EFR7300	SISU	5481102111	EFR7658
SCHMITZ	56793	EFR6308	SISU	5481102121	EFR7659
SCHMITZ	56794	EFR6309	SMB	103836	09.8543.10
SCHMITZ	K066608K50	2925705390	SMB	103836	93193600
SCHMITZ	SCB1035094	EFR7002	SMB	103836	FCR200A
SCHMITZ	SCB1035095	EFR7003	SMB	449418	09.8543.10
SCHMITZ	SCB1068118	2933601	SMB	449418	93193600
SCHMITZ	SCB1068119	CAC019	SMB	449418	FCR200A
SCHMITZ	SCB1068161	EFR7002	SMB	449445	09.8526.10
SCHMITZ	SCB1068162	EFR7003	SMB	449445	93102000
SCHMITZ	SCB4300557941	EFR6308	SMB	AJN00018	29154xx
SCHMITZ	SCB4300557942	EFR6309	SMB	M069018	09.8526.10
SCHMITZ CARGOBU	1182462	2920200604	SMB	M069018	93102000
SCHMITZ CARGOBU	1182957	2920200604	SMB	M069018	FCR199A
SCHWARZMULLER	106808	EFR6305	SMB	M069999	EFR7000
SCHWARZMULLER	106809	EFR6304	SMB	M070008	EFR7001
SCHWARZMULLER	106810	EFR7303	SMB	M076424	EFR7300
SCHWARZMULLER	106811	EFR7311	SMB	M076432	EFR7301
SCHWARZMULLER	106812	EFR7302	SMB	M076634	EFR7300
SCHWARZMULLER	106813	EFR7310	SMB	M076642	EFR7301
SCHWARZMULLER	107056	EFR6306	SMB	M078157	09.8543.10
SCHWARZMULLER	107057	EFR6307	SMB	M078157	93193600
SCHWARZMULLER	110914	EFR7303	SMB	M078157	FCR200A
SCHWARZMULLER	110915	EFR7302	SMB	M078386	EFR6300
SCHWARZMULLER	117708	EFR5301	SMB	M078394	EFR6301
SCHWARZMULLER	117709	EFR5303	SMB	M100659	29154xx

Les correspondances de références ont pour seul objectif d'aider la recherche de référence

Cross references are there for the sole purpose of helping the reference search

CORRESPONDANCES DES REFERENCES CROSS REFERENCE LIST

MARQUE/MAKER	REF/PN OES	REF/PN	MARQUE/MAKER	REF/PN OES	REF/PN
SMB	M100669	29154xx	SMB	M91002704	2914302
SMB	M100669	2920200604	SMB	M91004001	EFR7203
SMB	M100669	2927801	SMB	M91004003	EFR7203
SMB	M100669	CVP020K	SMB	M91004004	EFR7202
SMB	M100918	CAC005	SMB	M91004501	2920200604
SMB	M101000	EFR7300	SMB	M91004501	2925305390
SMB	M101019	EFR7301	SMB	M91004501	2927801
SMB	M20006701	EFR7203	SMB	M91004501	CVP020K
SMB	M20012401	EFR7301	SMB	M91004502	2920200604
SMB	M20012402	EFR7300	SMB	M91004502	2925305390
SMB	M20012411	EFR7301	SMB	M91004502	2927801
SMB	M20012412	EFR7300	SMB	M91004502	CVP020K
SMB	M20012421	EFR7301	SMB	M91004801	CAC024
SMB	M20012422	EFR7300	SMB	M91004801	CAC042
SMB	M20012431	EFR7301	SMB	M910052-01	CAC009
SMB	M20012432	EFR7300	SMB	M910062-01	CAC009
SMB	M20012441	EFR7301	SMB	M910062-02	CAC008
SMB	M20012442	EFR7300	SOLARIS	0870215084	2925305390
SMB	M20012501	EFR7203	SOLARIS	0870215084	2927802
SMB	M20012502	EFR7203	SOLARIS	0870215084	CVP020K
SMB	M20012511	EFR7202	SOLARIS	821358300	09.B325.40
SMB	M20012512	EFR7202	SOLARIS	821358300	93086800
SMB	M20012521	EFR7203	SOLARIS	821358300	FCR168A
SMB	M20012531	EFR7202	SOLARIS	870215084	2920200604
SMB	M200135	09.8526.10	STEYR	9524029	EFR7612
SMB	M200135	93102000	STEYR	9524030	EFR7613
SMB	M200135	FCR199A	TOUGHLINE	61002	EFR7304
SMB	M20013501	09.8526.10	TOUGHLINE	61003	EFR7305
SMB	M20013501	93102000	TOUGHLINE	61246	EFR6304
SMB	M20013501	FCR199A	TOUGHLINE	61248	EFR6305
SMB	M2001352	FCR362A	TOUGHLINE	61253	EFR7303
SMB	M20016401	EFR7301	TOUGHLINE	61254	EFR7302
SMB	M20016402	EFR7300	TOUGHLINE	61255	EFR7300
SMB	M20016421	EFR7301	TOUGHLINE	61256	EFR7301
SMB	M20016422	EFR7300	TOUGHLINE	61257	EFR7302
SMB	M20016431	EFR7301	TOUGHLINE	61258	EFR7303
SMB	M20016432	EFR7300	TRANSBUS	657303-128	CAC005
SMB	M20016441	EFR7301	TRANSBUS	658517-29	CAC005
SMB	M20016442	EFR7300	TRANSBUS	DEP102740	EFR7303
SMB	M20017701	EFR6300	TRANSBUS	DEP102741	EFR7302
SMB	M20017702	EFR6301	TRANSBUS	DEP102761	EFR7303
SMB	M20019201	EFR6300	TRANSBUS	DEP102762	EFR7302
SMB	M20019202	EFR6301	TRANSBUS	DP023141	EFR7303
SMB	M69018	09.8526.10	TRANSBUS	DP023142	EFR7302
SMB	M69018	93102000	UD TRUCKS	5222692958	2928401
SMB	M69018	FCR199A	UD TRUCKS	5222692958	CVP116K
SMB	M91000301	EFR6300	UD TRUCKS	5222828321	2927301
SMB	M91000302	EFR6301	UD TRUCKS	5222828321	CVP101K

Les correspondances de références ont pour seul objectif d'aider la recherche de référence

Cross references are there for the sole purpose of helping the reference search

CORRESPONDANCES DES REFERENCES CROSS REFERENCE LIST

MARQUE/MAKER	REF/PN OES	REF/PN	MARQUE/MAKER	REF/PN OES	REF/PN
VALX	1104517	W0760SA	VDL	30028311	EFR7304
VALX	5030000001	EFR6006	VDL	30028312	EFR7303
VALX	50300002	EFR7002	VDL	30028313	EFR7308
VALX	5030200001	EFR6007	VDL	30028317	EFR6300
VALX	50302003	EFR7003	VDL	30055685	EFR6301
VALX	50320001	2931302	VDL	30096071	EFR6306
VALX	50340001	CAC019	VDL	30096072	EFR6307
VALX	50380001	W0760SA	VDL	41142131	EFR6301
VAN HOOL	10770779	CAC014	VDL	41142133	EFR6300
VAN HOOL	10881856	EFR7638	VDL	41156386	EFR6301
VAN HOOL	10881859	EFR7639	VDL	41658010	EFR7328
VAN HOOL	10918882	EFR7638	VDL	TK0000092091	EFR7316
VAN HOOL	10918883	EFR7639	VDL	TK0000092092	EFR7317
VAN HOOL	10935183	EFR7696	VOLVO	1075847	EFR7630
VAN HOOL	10935189	EFR7697	VOLVO	1075848	EFR7631
VAN HOOL	10938969	EFR7718	VOLVO	1075851	EFR7622
VAN HOOL	10938973	EFR7719	VOLVO	1075852	EFR7623
VAN HOOL	11031121	CAC008	VOLVO	1078439	2927705
VAN HOOL	11099617	EFR7314	VOLVO	1078439	CVP037K
VAN HOOL	11099618	EFR7315	VOLVO	1078685	EFR7624
VAN HOOL	11099621	CAC024	VOLVO	1078686	EFR7625
VAN HOOL	11251414	EFR7310	VOLVO	1439494	CAC017
VAN HOOL	11251415	EFR7311	VOLVO	20300117	EFR6620
VAN HOOL	11269629	EFR7302	VOLVO	20300118	EFR6621
VAN HOOL	11335315	EFR7302	VOLVO	20390666	EFR7624
VAN HOOL	11335320	EFR7303	VOLVO	20390667	EFR7625
VAN HOOL	11335321	EFR7310	VOLVO	20390670	EFR7622
VAN HOOL	11335322	EFR7311	VOLVO	20390671	EFR7623
VAN HOOL	11335323	EFR7302	VOLVO	20399117	EFR6620
VAN HOOL	11335324	EFR7303	VOLVO	20399118	EFR6621
VAN HOOL	11385640	EFR7302	VOLVO	20400275	EFR7630
VAN HOOL	11385641	EFR7303	VOLVO	20400276	EFR7631
VAN HOOL	508030009	09.7320.10	VOLVO	20400277	EFR7622
VAN HOOL	508030009	93071800	VOLVO	20400278	EFR7623
VAN HOOL	508030009	FCR144A	VOLVO	20400319	EFR7618
VAN HOOL	N508026022	CAC030	VOLVO	20400320	EFR7619
VDL	20276964	EFR7301	VOLVO	20400321	EFR6626
VDL	20330069	EFR7302	VOLVO	20400322	EFR6627
VDL	234110	09.B325.40	VOLVO	20401057	EFR7624
VDL	234110	93086800	VOLVO	20401058	EFR7625
VDL	234110	FCR168A	VOLVO	20401778	EFR7618
VDL	30009479	EFR7305	VOLVO	20401779	EFR7619
VDL	30010897	EFR6300	VOLVO	20401784	EFR7618
VDL	30028303	EFR7303	VOLVO	20401785	EFR7619
VDL	30028304	EFR7302	VOLVO	20401798	EFR7618
VDL	30028305	EFR7317	VOLVO	20401799	EFR7619
VDL	30028308	EFR7316	VOLVO	20401806	EFR7630
VDL	30028310	EFR7300	VOLVO	20401807	EFR7631

Les correspondances de références ont pour seul objectif d'aider la recherche de référence

Cross references are there for the sole purpose of helping the reference search

CORRESPONDANCES DES REFERENCES CROSS REFERENCE LIST

MARQUE/MAKER	REF/PN OES	REF/PN	MARQUE/MAKER	REF/PN OES	REF/PN
VOLVO	20401810	EFR7622	VOLVO	20527569	EFR7677R
VOLVO	20401811	EFR7623	VOLVO	20527570	EFR7690
VOLVO	20401812	EFR7624	VOLVO	20527571	EFR7691
VOLVO	20401813	EFR7625	VOLVO	20535920	EFR7706
VOLVO	2041784	EFR7618	VOLVO	20535921	EFR7707
VOLVO	2041785	EFR7619	VOLVO	20535922	2913111
VOLVO	20424070	EFR7624	VOLVO	20535922	CVP088K
VOLVO	20424071	EFR7625	VOLVO	20538183	EFR7676
VOLVO	20424072	EFR7630	VOLVO	20538184	EFR7677
VOLVO	20424073	EFR7631	VOLVO	20560412	2917400604
VOLVO	20424074	EFR7622	VOLVO	20560412	2917401
VOLVO	20424075	EFR7623	VOLVO	20560412	CVP101K
VOLVO	20424082	EFR7630	VOLVO	20560414	2917300604
VOLVO	20424083	EFR7631	VOLVO	20560414	2917301
VOLVO	20442328	EFR6620	VOLVO	20560414	CVP100K
VOLVO	20442329	EFR6621	VOLVO	20560415	2917705
VOLVO	20442330	EFR7628	VOLVO	20560415	CVP095K
VOLVO	20442331	EFR7629	VOLVO	20564467	09.E161.10
VOLVO	20498844	EFR7690	VOLVO	20564467	93243400
VOLVO	20498845	EFR7691	VOLVO	20564467	FCR353A
VOLVO	20498846	EFR6656	VOLVO	20566582	EFR7676
VOLVO	20498847	EFR6657	VOLVO	20566583	EFR7677
VOLVO	20515093	93272000	VOLVO	20566777	EFR7678
VOLVO	20515093	DF70010	VOLVO	20566778	EFR7679
VOLVO	20515093	FCR259A	VOLVO	20566779	EFR7678
VOLVO	20523409	93322800	VOLVO	20566780	EFR7679
VOLVO	20523409	DF70011	VOLVO	20566786	EFR7680
VOLVO	20523409	FCR328A	VOLVO	20566787	EFR7681
VOLVO	20523553	EFR7688	VOLVO	20568711	2917400604
VOLVO	20523648	EFR7689	VOLVO	20568711	2917401
VOLVO	20523651	EFR7676R	VOLVO	20568711	CVP101K
VOLVO	20523652	EFR7677R	VOLVO	20568712	2917300604
VOLVO	20526568	2917400604	VOLVO	20568712	2917301
VOLVO	20526568	2917401	VOLVO	20568712	CVP100K
VOLVO	20526568	CVP101K	VOLVO	20568713	2917705
VOLVO	20526570	2917705	VOLVO	20568713	CVP095K
VOLVO	20526570	CVP095K	VOLVO	20568714	2917400604
VOLVO	20526990	EFR7688	VOLVO	20568714	2917401
VOLVO	20526991	EFR7689	VOLVO	20568714	CVP101K
VOLVO	20527036	EFR7676R	VOLVO	20568715	2917300604
VOLVO	20527037	EFR7677R	VOLVO	20568715	2917301
VOLVO	20527038	EFR7690	VOLVO	20568715	CVP100K
VOLVO	20527039	EFR7691	VOLVO	20576594	EFR7676
VOLVO	20527041	EFR6656	VOLVO	20576598	EFR7677
VOLVO	20527043	EFR6657	VOLVO	20578291	EFR6600
VOLVO	20527330	EFR7688	VOLVO	20578292	EFR6601
VOLVO	20527556	EFR7689	VOLVO	20579180	EFR7676
VOLVO	20527566	EFR7676R	VOLVO	20579182	EFR7676

Les correspondances de références ont pour seul objectif d'aider la recherche de référence

Cross references are there for the sole purpose of helping the reference search

CORRESPONDANCES DES REFERENCES CROSS REFERENCE LIST

MARQUE/MAKER	REF/PN OES	REF/PN	MARQUE/MAKER	REF/PN OES	REF/PN
VOLVO	20579186	EFR7677	VOLVO	20785384	EFR6621
VOLVO	20579187	EFR7676	VOLVO	20825594	2909006
VOLVO	20579188	EFR7677	VOLVO	20825594	2909009
VOLVO	20700508	09.9497.10	VOLVO	20825594	CVP023K
VOLVO	20700508	FCR374A	VOLVO	20838459	EFR7612
VOLVO	20700509	09.9494.40	VOLVO	20838461	EFR7613
VOLVO	20700509	93222700	VOLVO	20842687	EFR6200
VOLVO	20700509	DF60002	VOLVO	20844903	2918100604
VOLVO	20700509	FCR324A	VOLVO	20844903	2918101
VOLVO	20704259	EFR7678	VOLVO	20850194	2909009
VOLVO	20704422	09.9496.10	VOLVO	20850194	CVP023K
VOLVO	20704422	93192500	VOLVO	20852499	EFR7628
VOLVO	20704422	FCR378A	VOLVO	20852506	EFR7629
VOLVO	20704423	09.9495.40	VOLVO	20852527	EFR7624
VOLVO	20704423	93192300	VOLVO	20852528	EFR7625
VOLVO	20704423	DF60001	VOLVO	20852529	EFR7622
VOLVO	20704423	FCR325A	VOLVO	20852531	EFR7630
VOLVO	20706903	EFR7688R	VOLVO	20852532	EFR7631
VOLVO	20706907	EFR7676R	VOLVO	20898083	EFR7691
VOLVO	20706909	EFR7680R	VOLVO	20918891	2927705
VOLVO	20706909	EFR7690R	VOLVO	20918891	CVP037K
VOLVO	20712403	EFR7677R	VOLVO	20931241	09.9494.40
VOLVO	20713402	EFR7689R	VOLVO	20931241	93222700
VOLVO	20713403	EFR7677R	VOLVO	20931241	DF60002
VOLVO	20713404	EFR7681R	VOLVO	20931241	FCR324A
VOLVO	20713404	EFR7691R	VOLVO	20931249	09.9497.10
VOLVO	20763234	09.9498.10	VOLVO	20931249	FCR374A
VOLVO	20763234	FCR375A	VOLVO	209313430	2927705
VOLVO	20765963	2917705	VOLVO	209313430	CVP037K
VOLVO	20765963	CVP095K	VOLVO	20932682	2927705
VOLVO	20768092	2927705	VOLVO	20932682	CVP037K
VOLVO	20768092	CVP037K	VOLVO	20976509	2913111
VOLVO	20768101	2915102	VOLVO	20976509	CVP088K
VOLVO	20768115	2913706	VOLVO	20982064	EFR7688
VOLVO	20777352	CAC011	VOLVO	20982069	EFR7689
VOLVO	20780777	EFR6200	VOLVO	20982100	EFR7688
VOLVO	20780779	EFR6200	VOLVO	20982103	EFR7689
VOLVO	20780780	EFR6200	VOLVO	20995144	09.E161.10
VOLVO	20780785	EFR7691	VOLVO	20995144	93243400
VOLVO	20780788	2918100604	VOLVO	20995144	FCR353A
VOLVO	20780788	2918101	VOLVO	2100046	09.9495.40
VOLVO	20783331	EFR7624	VOLVO	2100046	93192300
VOLVO	20783332	EFR7625	VOLVO	2100046	DF60001
VOLVO	20783333	EFR7622	VOLVO	2100046	FCR325A
VOLVO	20783334	EFR7623	VOLVO	21024421	EFR7676R
VOLVO	20785370	EFR7630	VOLVO	21024422	EFR7677R
VOLVO	20785371	EFR7631	VOLVO	21024701	2917400604
VOLVO	20785383	EFR6620	VOLVO	21024701	2917402

Les correspondances de références ont pour seul objectif d'aider la recherche de référence

Cross references are there for the sole purpose of helping the reference search

CORRESPONDANCES DES REFERENCES CROSS REFERENCE LIST

MARQUE/MAKER	REF/PN OES	REF/PN	MARQUE/MAKER	REF/PN OES	REF/PN
VOLVO	21024701	CVP101K	VOLVO	21575071	93272000
VOLVO	21024702	2917400604	VOLVO	21575071	DF70010
VOLVO	21024702	2917402	VOLVO	21575071	FCR259A
VOLVO	21024702	CVP101K	VOLVO	21697599	EFR5010
VOLVO	21088907	2927705	VOLVO	21697600	EFR5011
VOLVO	21088907	CVP037K	VOLVO	21697602	EFR5012
VOLVO	21120755	EFR7624	VOLVO	21697603	EFR5013
VOLVO	21120756	EFR7625	VOLVO	21697604	EFR6012
VOLVO	21120758	EFR7630	VOLVO	21697605	EFR6013
VOLVO	21120759	EFR7631	VOLVO	21697606	EFR6013
VOLVO	21120760	EFR7622	VOLVO	21697607	EFR6014
VOLVO	21120761	EFR7623	VOLVO	21697609	EFR6015
VOLVO	2112758	EFR7630	VOLVO	21697610	EFR5010
VOLVO	2112759	EFR7631	VOLVO	21697611	EFR5011
VOLVO	21309468	2913111	VOLVO	21697614	EFR5012
VOLVO	21309468	CVP088K	VOLVO	21697615	EFR5013
VOLVO	21352570	2917400604	VOLVO	21697616	EFR6012
VOLVO	21352570	2917401	VOLVO	21697617	EFR6013
VOLVO	21352570	CVP101K	VOLVO	21697618	EFR6013
VOLVO	21352573	2917300604	VOLVO	21697619	EFR6014
VOLVO	21352573	2917301	VOLVO	21697620	EFR6015
VOLVO	21352573	CVP100K	VOLVO	21742379	EFR6014
VOLVO	21454874	CAC018	VOLVO	21749392	EFR5012
VOLVO	21457165	CAC019	VOLVO	21749396	EFR5013
VOLVO	21487594	EFR7688	VOLVO	21750256	EFR6014
VOLVO	21487595	EFR7689	VOLVO	21750257	EFR6015
VOLVO	21487603	EFR7676R	VOLVO	21769791	EFR5010
VOLVO	21487612	EFR7690	VOLVO	21769794	EFR5011
VOLVO	21487613	EFR7691	VOLVO	21769799	EFR6012
VOLVO	21487655	EFR7677	VOLVO	21769800	EFR6013
VOLVO	21487684	EFR7688	VOLVO	22069821	09.9493.20
VOLVO	21487685	EFR7689	VOLVO	22069821	DF50003
VOLVO	21488186	2917301	VOLVO	22594800	EFR6008
VOLVO	21488186	CVP100K	VOLVO	22594801	EFR6009
VOLVO	21496550	2917400604	VOLVO	23149531	2927705
VOLVO	21496550	2917401	VOLVO	23149531	CVP037K
VOLVO	21496550	2927301	VOLVO	23149532	2917400604
VOLVO	21496550	CVP101K	VOLVO	23149532	2917401
VOLVO	21496551	2917300604	VOLVO	23149532	2927301
VOLVO	21496551	2927201	VOLVO	23149532	CVP101K
VOLVO	21496551	CVP100K	VOLVO	27068092	2927705
VOLVO	21496552	2917705	VOLVO	27068092	CVP037K
VOLVO	21496552	CVP095K	VOLVO	3086396	2927705
VOLVO	21538255	2928501	VOLVO	3086396	CVP037K
VOLVO	21538255	2928503	VOLVO	3092251	EFR7624
VOLVO	21538255	CVP032K	VOLVO	3092252	EFR7625
VOLVO	21538279	2928401	VOLVO	3092255	CAC013
VOLVO	21538279	CVP116K	VOLVO	3092272	CAC011

Les correspondances de références ont pour seul objectif d'aider la recherche de référence

Cross references are there for the sole purpose of helping the reference search

CORRESPONDANCES DES REFERENCES CROSS REFERENCE LIST

MARQUE/MAKER	REF/PN OES	REF/PN	MARQUE/MAKER	REF/PN OES	REF/PN
VOLVO	3092282	CAC001	VOLVO	6775227	FCR142A
VOLVO	3092710	93272100	VOLVO	67752273	09.9746.10
VOLVO	3092710	DF70005	VOLVO	67752273	93086500
VOLVO	3092710	FCR249A	VOLVO	67752273	FCR142A
VOLVO	3093530	2913706	VOLVO	67752279	09.9746.10
VOLVO	3093531	2913606	VOLVO	67752279	93086500
VOLVO	3093532	2913706	VOLVO	67752279	FCR142A
VOLVO	3093596	2927705	VOLVO	6775229	09.9746.10
VOLVO	3093596	CVP037K	VOLVO	6775229	93086500
VOLVO	3093919	2909006	VOLVO	6775229	FCR142A
VOLVO	3093919	2909009	VOLVO	6779203	09.9745.10
VOLVO	3093919	CVP023K	VOLVO	6779203	93128200
VOLVO	3093939	2909006	VOLVO	6779203	FCR306A
VOLVO	3093939	CVP023K	VOLVO	6779209	09.9745.10
VOLVO	3095396	2927705	VOLVO	6779209	93128200
VOLVO	3095396	CVP037K	VOLVO	6779209	FCR306A
VOLVO	3095619	EFR7622	VOLVO	67792093	09.9745.10
VOLVO	3095620	EFR7623	VOLVO	67792093	93128200
VOLVO	3095632	08.8240.10	VOLVO	67792093	FCR306A
VOLVO	3095632	93308600	VOLVO	68323231	08.8240.10
VOLVO	3095632	FCR303A	VOLVO	68323231	93308600
VOLVO	3095652	08.8240.10	VOLVO	68323231	FCR303A
VOLVO	3095652	93308600	VOLVO	68323233	93243000
VOLVO	3095652	FCR303A	VOLVO	68323233	FCR278A
VOLVO	3095653	DF713814	VOLVO	68323825	09.8579.10
VOLVO	3095662	EFR6626	VOLVO	6832382504	09.8579.10
VOLVO	3095663	EFR6627	VOLVO	6832382504	93192700
VOLVO	3095672	DF713813	VOLVO	6832382504	FCR250A
VOLVO	3095673	93243000	VOLVO	70301332	EFR7612
VOLVO	3095673	FCR278A	VOLVO	70301333	EFR7613
VOLVO	3096766	EFR7624	VOLVO	70306886	EFR7612
VOLVO	3096767	EFR7625	VOLVO	70306887	EFR7613
VOLVO	3099533	2915102	VOLVO	70311512	EFR7612
VOLVO	3112965	09.9396.10	VOLVO	70311513	EFR7613
VOLVO	3112965	93105500	VOLVO	70330022	EFR7612
VOLVO	3112965	FCR192A	VOLVO	70330023	EFR7613
VOLVO	3118128	98025200	VOLVO	82196750	09.A779.20
VOLVO	3198394	2915102	VOLVO	82421140	09.9495.40
VOLVO	3199272	EFR7630	VOLVO	82421140	93192300
VOLVO	3199273	EFR7631	VOLVO	82421140	DF60001
VOLVO	3199274	EFR7622	VOLVO	82421140	FCR325A
VOLVO	3199275	EFR7623	VOLVO	85003245	EFR7624
VOLVO	3903532	2913706	VOLVO	85003246	EFR7625
VOLVO	6775223	09.9746.10	VOLVO	85003247	EFR7630
VOLVO	6775223	93086500	VOLVO	85003248	EFR7631
VOLVO	6775223	FCR142A	VOLVO	85003249	EFR7622
VOLVO	6775227	09.9746.10	VOLVO	85003250	EFR7623
VOLVO	6775227	93086500	VOLVO	85003916	EFR6200

Les correspondances de références ont pour seul objectif d'aider la recherche de référence

Cross references are there for the sole purpose of helping the reference search

CORRESPONDANCES DES REFERENCES CROSS REFERENCE LIST

MARQUE/MAKER	REF/PN OES	REF/PN	MARQUE/MAKER	REF/PN OES	REF/PN
VOLVO	85101082	EFR7622	VOLVO	85110495	FCR348A
VOLVO	85101083	EFR7623	VOLVO	8550611	2909006
VOLVO	85102094	CAC013	VOLVO	8550611	CVP023K
VOLVO	85102227	EFR7612	VOLVO	85506111	2909006
VOLVO	85102228	EFR7613	VOLVO	85506111	2909009
VOLVO	85103302	EFR6626	VOLVO	85506111	CVP023K
VOLVO	85103303	EFR6627	VOLVO	8550875	EFR7612
VOLVO	85103803	93272000	VOLVO	8550876	EFR7613
VOLVO	85103803	DF70010	VOLVO	8551042	93272100
VOLVO	85103803	FCR259A	VOLVO	8551042	DF70005
VOLVO	85103804	93322700	VOLVO	8551042	FCR249A
VOLVO	85103804	DF70009	VOLVO	9957385	EFR7612
VOLVO	85103804	FCR348A	VOLVO	9957386	EFR7613
VOLVO	85103805	93322800	WABCO	12182190	2913401
VOLVO	85103805	DF70011	WABCO	12480021	W0295MA1
VOLVO	85103805	FCR328A	WABCO	12999629VT	2905503
VOLVO	85103806	93322700	WABCO	12999665VT	2907702
VOLVO	85103806	DF70009	WABCO	12999676VT	29154xx
VOLVO	85103806	FCR348A	WABCO	12999697VT	2928503
VOLVO	85103892	CAC013	WABCO	12999697VT	CVP032K
VOLVO	85105485	2909006	WABCO	12999698VT	2928503
VOLVO	85105485	2909009	WABCO	12999698VT	CVP032K
VOLVO	85105485	CVP023K	WABCO	12999699VT	CAC017
VOLVO	85105655	CAC019	WABCO	12999702VT	CAC017
VOLVO	85106925	EFR7624	WABCO	12999703VT	2928503
VOLVO	85106926	EFR7625	WABCO	12999703VT	CVP032K
VOLVO	85106927	EFR7622	WABCO	12999728	09.7804.60
VOLVO	85106928	EFR7623	WABCO	12999728	93127400
VOLVO	85106929	EFR7630	WABCO	12999728	FCR237A
VOLVO	85106930	EFR7631	WABCO	12999732VT	2913401
VOLVO	85106931	EFR6620	WABCO	12999743VT	2928502
VOLVO	85106932	EFR6621	WABCO	12999743VT	CVP032K
VOLVO	85107719	EFR7618	WABCO	12999746VT	CAC018
VOLVO	85107720	EFR7619	WABCO	12999747VT	FCV1389
VOLVO	85107768	2913111	WABCO	12999755VT	W0760SA
VOLVO	85107768	CVP088K	WABCO	12999756	09.9361.10
VOLVO	85107908	EFR7706	WABCO	12999756	93187700
VOLVO	85107909	EFR7707	WABCO	12999756	FCR350A
VOLVO	85107912	CAC012	WABCO	12999757	93142500
VOLVO	85107913	CAC011	WABCO	12999757	FCR256A
VOLVO	85107958	CAC040	WABCO	12999758	93187800
VOLVO	85108166	CAC019	WABCO	12999758	FCR226A
VOLVO	85109889	CAC027	WABCO	12999759	09.E452.20
VOLVO	85109890	CAC028	WABCO	12999759	93142800
VOLVO	85110419	98027600	WABCO	12999759	FCR258A
VOLVO	85110419	W0355RT1V1	WABCO	12999760	09.9354.10
VOLVO	85110495	93322700	WABCO	12999760	93142700
VOLVO	85110495	DF70009	WABCO	12999760	FCR257A

Les correspondances de références ont pour seul objectif d'aider la recherche de référence

Cross references are there for the sole purpose of helping the reference search

CORRESPONDANCES DES REFERENCES CROSS REFERENCE LIST

MARQUE/MAKER	REF/PN OES	REF/PN	MARQUE/MAKER	REF/PN OES	REF/PN
WABCO	12999770	2931303	WABCO	40175073	EFR5003
WABCO	12999776	CAC019	WABCO	40175078	EFR5002
WABCO	12999782	2928502	WABCO	40175079	EFR5003
WABCO	12999782	CVP032K	WABCO	40175080	EFR5006
WABCO	12999791	2931301	WABCO	40175081	EFR5007
WABCO	12999796	2933601	WABCO	40175090	EFR5002
WABCO	13162025	09.8526.10	WABCO	40175091	EFR5003
WABCO	13162025	93102000	WABCO	40195001	EFR6006
WABCO	13162025	FCR199A	WABCO	40195002	EFR6007
WABCO	13229196	CAC020	WABCO	40195003	EFR6006
WABCO	13229197	CAC021	WABCO	40195004	EFR6007
WABCO	13229219	CAC022	WABCO	40195009	EFR6002
WABCO	13229220	CAC023	WABCO	40195010	EFR6003
WABCO	3403220002	2927900604	WABCO	40195017	EFR6006
WABCO	3403220002	2927901	WABCO	40195018	EFR6007
WABCO	40100001	EFR5008	WABCO	40195021	EFR6002
WABCO	40100002	EFR5009	WABCO	40195022	EFR6003
WABCO	40130007	EFR6124	WABCO	40195027	EFR6006
WABCO	40130008	EFR6125	WABCO	40195028	EFR6007
WABCO	40160015	EFR5004	WABCO	40195029	EFR6006
WABCO	40160016	EFR5005	WABCO	40195030	EFR6007
WABCO	40175013	EFR5006	WABCO	40195033	EFR6008
WABCO	40175014	EFR5007	WABCO	40195034	EFR6009
WABCO	40175023	EFR5006	WABCO	40195035	EFR6006
WABCO	40175024	EFR5007	WABCO	40195036	EFR6007
WABCO	40175025	EFR5006	WABCO	40195037	EFR6006
WABCO	40175026	EFR5007	WABCO	40195038	EFR6007
WABCO	40175027	EFR5006	WABCO	40195041	EFR6008
WABCO	40175028	EFR5007	WABCO	40195042	EFR6009
WABCO	40175049	EFR5006	WABCO	40195043	EFR6004
WABCO	40175050	EFR5007	WABCO	40195044	EFR6005
WABCO	40175051	EFR5006	WABCO	40195045	EFR6004
WABCO	40175052	EFR5007	WABCO	40195046	EFR6005
WABCO	40175056	EFR5006	WABCO	40195055	EFR6004
WABCO	40175057	EFR5007	WABCO	40195056	EFR6005
WABCO	40175058	EFR5002	WABCO	40225003	EFR7000
WABCO	40175059	EFR5003	WABCO	40225004	EFR7001
WABCO	40175060	EFR5002	WABCO	40225005	EFR7000
WABCO	40175061	EFR5003	WABCO	40225006	EFR7001
WABCO	40175062	EFR5000	WABCO	40225007	EFR7002
WABCO	40175063	EFR5001	WABCO	40225008	EFR7003
WABCO	40175064	EFR5000	WABCO	40225011	EFR7002
WABCO	40175065	EFR5001	WABCO	40225012	EFR7003
WABCO	40175068	EFR5002	WABCO	40225015	EFR7002
WABCO	40175069	EFR5003	WABCO	40225016	EFR7003
WABCO	40175070	EFR5002	WABCO	40225017	EFR7002
WABCO	40175071	EFR5003	WABCO	40225018	EFR7003
WABCO	40175072	EFR5002	WABCO	6401750930	EFR5000

Les correspondances de références ont pour seul objectif d'aider la recherche de référence

Cross references are there for the sole purpose of helping the reference search

CORRESPONDANCES DES REFERENCES CROSS REFERENCE LIST

MARQUE/MAKER	REF/PN OES	REF/PN	MARQUE/MAKER	REF/PN OES	REF/PN
WABCO	6401750940	EFR5001	WABCO	6403170140	EFR5013
WABCO	6401750960	EFR5000	WABCO	6403170150	EFR5012
WABCO	6401750970	EFR5001	WABCO	6403170160	EFR5013
WABCO	6401751200	EFR5002	WABCO	6403170410	EFR5010
WABCO	6401751210	EFR5003	WABCO	6403170420	EFR5011
WABCO	6401759232	2928501	WABCO	6403170430	EFR5012
WABCO	6401759232	CVP032K	WABCO	6403170440	EFR5013
WABCO	6401759402	CAC020	WABCO	6403179322	2928503
WABCO	6401759402	CAC021	WABCO	6403179322	CVP032K
WABCO	6401950620	EFR6008	WABCO	6403190010	EFR6012
WABCO	6401950680	EFR6010	WABCO	6403190020	EFR6013
WABCO	6401950690	EFR6011	WABCO	6403190030	EFR6012
WABCO	6401950870	EFR6006	WABCO	6403190040	EFR6013
WABCO	6401950880	EFR6007	WABCO	6403190080	EFR6013
WABCO	6401950920	EFR6004	WABCO	6403190090	EFR6014
WABCO	6401950930	EFR6005	WABCO	6403190100	EFR6015
WABCO	6401951210	EFR6008	WABCO	6403190110	EFR6014
WABCO	6401951220	EFR6009	WABCO	6403190120	EFR6015
WABCO	6401959322	2931302	WABCO	6403190270	EFR6012
WABCO	6401959332	2931302	WABCO	6403190280	EFR6013
WABCO	6401959362	CAC022	WABCO	6403190290	EFR6014
WABCO	6401959362	CAC023	WABCO	6403190300	EFR6015
WABCO	6402229232	2933606	WABCO	6403199302	2928401
WABCO	6402250002	EFR7002	WABCO	6403199302	CVP116K
WABCO	6402250012	EFR7003	WABCO	6403199322	98065500
WABCO	6402250030	EFR7000	WABCO	6403199322	W0335RT1
WABCO	6402250040	EFR7001	WABCO	6403220040	EFR7004
WABCO	6402250070	EFR7002	WABCO	6403220050	EFR7005
WABCO	6402250080	EFR7003	WABCO	6403220070	EFR7006
WABCO	6402250110	EFR7002	WABCO	6403220080	EFR7007
WABCO	6402250120	EFR7003	WABCO	6403220310	EFR7004
WABCO	6402250150	EFR7002	WABCO	640322031R	EFR7004
WABCO	640225015R	EFR7002	WABCO	6403220320	EFR7005
WABCO	6402250160	EFR7003	WABCO	640322032R	EFR7005
WABCO	640225016R	EFR7003	WABCO	6403220340	EFR7006
WABCO	6402250220	EFR7008	WABCO	640322034R	EFR7006
WABCO	6402250230	EFR7009	WABCO	6403220350	EFR7007
WABCO	6402250250	EFR7008	WABCO	640322035R	EFR7007
WABCO	6402250260	EFR7009	WABCO	6403220600	EFR7005
WABCO	6402250300	EFR7002	WABCO	6403220610	EFR7004
WABCO	6402250310	EFR7003	WABCO	6403220620	EFR7006
WABCO	6402250400	EFR7002	WABCO	6403220630	EFR7007
WABCO	6402250410	EFR7003	WABCO	6403220690	EFR7004
WABCO	6403170050	EFR5010	WABCO	6403220700	EFR7005
WABCO	6403170060	EFR5011	WABCO	6403220710	EFR7006
WABCO	6403170070	EFR5010	WABCO	6403220720	EFR7007
WABCO	6403170080	EFR5011	WABCO	6403220750	EFR7010
WABCO	6403170130	EFR5012	WABCO	6403220760	EFR7011

Les correspondances de références ont pour seul objectif d'aider la recherche de référence

Cross references are there for the sole purpose of helping the reference search

CORRESPONDANCES DES REFERENCES CROSS REFERENCE LIST

MARQUE/MAKER	REF/PN OES	REF/PN	MARQUE/MAKER	REF/PN OES	REF/PN
WABCO	6403220890	EFR7004	ZF	0501006293	EFR7304
WABCO	6403220900	EFR7005	ZF	0501006294	EFR7305
WABCO	6403220920	EFR7006	ZF	0501006296	EFR7310
WABCO	6403220930	EFR7007	ZF	0501006297	EFR7311
WABCO	6403220980	EFR7010	ZF	0501006320	EFR7304
WABCO	6403220990	EFR7011	ZF	0501006321	EFR7305
WABCO	6403221342	2927900604	ZF	0501006362	EFR7302
WABCO	6403221342	2927901	ZF	0501006363	EFR7303
WABCO	6403229242	2927900604	ZF	0501006378	EFR7304
WABCO	6403229242	2927901	ZF	0501006379	EFR7305
WABCO	6403229302	2927900604	ZF	0501006380	EFR7304
WABCO	6403229302	2927901	ZF	0501006381	EFR7305
WABCO	6403229332	2927900604	ZF	0501006435	EFR7310
WABCO	6403229332	2927901	ZF	0501006436	EFR7311
WABCO	6403229442	2931501	ZF	0501006513	EFR7638
WABCO	6403229442	29315FLE1749	ZF	0501006514	EFR7639
WABCO	640322949R	EFR7010	ZF	0501006591	EFR7314
WABCO	640322950R	EFR7011	ZF	0501006592	EFR7315
WABCO	6403229522	2931501	ZF	0501006594	EFR7314
WABCO	6403229522	29315FLE1749	ZF	0501006595	EFR7315
WABCO	6403229582	2931501	ZF	0501006597	EFR7314
WABCO	6403229582	29315FLE1749	ZF	0501006598	EFR7315
WABCO	6409050522	2933601	ZF	0501006599	EFR7316
WABCO	6621756162	DF713891	ZF	0501006600	EFR7317
ZF	0501003935	EFR7606	ZF	0501006604	EFR7300
ZF	0501003936	EFR7607	ZF	0501006605	EFR7301
ZF	0501004588	EFR7607	ZF	0501006661	EFR7638
ZF	0501004589	EFR7606	ZF	0501006662	EFR7639
ZF	0501005172	EFR7303	ZF	0501006698	EFR7300
ZF	0501005173	EFR7302	ZF	0501006699	EFR7301
ZF	0501005370	EFR7302	ZF	0501006754	EFR7306
ZF	0501005371	EFR7303	ZF	0501006755	EFR7307
ZF	0501005573	EFR7306	ZF	0501006838	EFR7314
ZF	0501005574	EFR7307	ZF	0501006839	EFR7315
ZF	0501005859	EFR7302	ZF	0501006850	EFR7316
ZF	0501005860	EFR7303	ZF	0501006851	EFR7317
ZF	0501005905	EFR7302	ZF	0501006901	EFR7638
ZF	0501005906	EFR7303	ZF	0501006902	EFR7639
ZF	0501005935	EFR7302	ZF	0501007035	EFR7302
ZF	0501005936	EFR7303	ZF	0501007036	EFR7303
ZF	0501006007	EFR7316	ZF	0501007056	EFR7317
ZF	0501006008	EFR7317	ZF	0501007057	EFR7316
ZF	0501006016	EFR7302	ZF	0501007071	EFR7316
ZF	0501006017	EFR7303	ZF	0501007072	EFR7317
ZF	0501006195	EFR7314	ZF	0501007085	EFR7304
ZF	0501006196	EFR7315	ZF	0501007086	EFR7305
ZF	0501006211	EFR7314	ZF	0501007125	EFR7303
ZF	0501006212	EFR7315	ZF	0501007126	EFR7302

Les correspondances de références ont pour seul objectif d'aider la recherche de référence

Cross references are there for the sole purpose of helping the reference search

CORRESPONDANCES DES REFERENCES CROSS REFERENCE LIST

MARQUE/MAKER	REF/PN OES	REF/PN	MARQUE/MAKER	REF/PN OES	REF/PN
ZF	0501007140	EFR7301	ZF	0501007333	EFR7314
ZF	0501007141	EFR7300	ZF	0501007334	EFR7315
ZF	0501007152	EFR7302	ZF	0501007361	EFR7314
ZF	0501007153	EFR7303	ZF	0501007362	EFR7315
ZF	0501007155	EFR7302	ZF	0501007363	EFR7314
ZF	0501007156	EFR7303	ZF	0501007364	EFR7315
ZF	0501007160	EFR7302	ZF	0501007367	EFR7304
ZF	0501007161	EFR7303	ZF	0501007368	EFR7305
ZF	0501007163	EFR7300	ZF	0501007374	EFR7300
ZF	0501007164	EFR7301	ZF	0501007375	EFR7301
ZF	0501007166	EFR7310	ZF	0501007388	EFR7302
ZF	0501007167	EFR7311	ZF	0501007389	EFR7303
ZF	0501007172	EFR7316	ZF	0501007394	EFR7310
ZF	0501007173	EFR7317	ZF	0501007395	EFR7311
ZF	0501007175	EFR7314	ZF	0501007397	EFR7314
ZF	0501007176	EFR7315	ZF	0501007398	EFR7315
ZF	0501007178	EFR7300	ZF	0501007416	EFR7316
ZF	0501007179	EFR7301	ZF	0501007417	EFR7317
ZF	0501007181	EFR7306	ZF	0501007462	EFR7302
ZF	0501007182	EFR7307	ZF	0501007463	EFR7303
ZF	0501007186	EFR7314	ZF	0501007471	EFR7638
ZF	0501007187	EFR7315	ZF	0501007472	EFR7639
ZF	0501007189	EFR7316	ZF	0501007475	EFR7304
ZF	0501007190	EFR7317	ZF	0501007476	EFR7305
ZF	0501007191	EFR7316	ZF	0501007477	EFR7304
ZF	0501007192	EFR7317	ZF	0501007478	EFR7305
ZF	0501007194	EFR7302	ZF	0501007543	EFR7310
ZF	0501007195	EFR7303	ZF	0501007544	EFR7311
ZF	0501007197	EFR7316	ZF	0501007568	EFR7316
ZF	0501007198	EFR7317	ZF	0501007569	EFR7317
ZF	0501007200	EFR7310	ZF	0501007571	EFR7310
ZF	0501007201	EFR7311	ZF	0501007572	EFR7311
ZF	0501007203	EFR7314	ZF	0501007587	EFR6305
ZF	0501007204	EFR7315	ZF	0501007588	EFR6304
ZF	0501007205	EFR7302	ZF	0501007594	EFR7304
ZF	0501007206	EFR7303	ZF	0501007595	EFR7305
ZF	0501007208	EFR7302	ZF	0501007640	EFR7638
ZF	0501007209	EFR7303	ZF	0501007641	EFR7639
ZF	0501007228	EFR7316	ZF	0501007644	EFR7302
ZF	0501007229	EFR7317	ZF	0501007645	EFR7303
ZF	0501007231	EFR7300	ZF	0501007677	EFR7310
ZF	0501007232	EFR7301	ZF	0501007678	EFR7311
ZF	0501007233	EFR7300	ZF	0501007680	EFR7314
ZF	0501007234	EFR7301	ZF	0501007681	EFR7315
ZF	0501007243	EFR7310	ZF	0501007700	EFR7300
ZF	0501007244	EFR7311	ZF	0501007701	EFR7301
ZF	0501007327	EFR7638	ZF	0501007702	EFR7720
ZF	0501007328	EFR7639	ZF	0501007703	EFR7721

Les correspondances de références ont pour seul objectif d'aider la recherche de référence

Cross references are there for the sole purpose of helping the reference search

CORRESPONDANCES DES REFERENCES CROSS REFERENCE LIST

MARQUE/MAKER	REF/PN OES	REF/PN	MARQUE/MAKER	REF/PN OES	REF/PN
ZF	0501007719	EFR7310	ZF	0501008020	EFR7304
ZF	0501007720	EFR7311	ZF	0501008021	EFR7305
ZF	0501007729	EFR7300	ZF	0501008022	EFR7304
ZF	0501007730	EFR7301	ZF	0501008023	EFR7305
ZF	0501007734	EFR7315	ZF	0501008025	EFR7310
ZF	0501007735	EFR7314	ZF	0501008026	EFR7311
ZF	0501007742	EFR7684	ZF	0501008027	EFR7310
ZF	0501007743	EFR7685	ZF	0501008028	EFR7311
ZF	0501007745	EFR7316	ZF	0501008037	EFR7340
ZF	0501007746	EFR7317	ZF	0501008038	EFR7341
ZF	0501007772	EFR7720	ZF	0501008040	EFR7314
ZF	0501007773	EFR7721	ZF	0501008041	EFR7315
ZF	0501007786	EFR7706	ZF	0501008045	EFR7302
ZF	0501007787	EFR7707	ZF	0501008046	EFR7303
ZF	0501007884	EFR7323	ZF	0501008048	EFR7310
ZF	0501007885	EFR7322	ZF	0501008049	EFR7311
ZF	0501007889	EFR7300	ZF	0501008051	EFR7310
ZF	0501007890	EFR7301	ZF	0501008052	EFR7311
ZF	0501007893	EFR7314	ZF	0501008054	EFR7300
ZF	0501007894	EFR7315	ZF	0501008055	EFR7301
ZF	0501007967	EFR7300	ZF	0501008061	EFR7323
ZF	0501007968	EFR7301	ZF	0501008062	EFR7322
ZF	0501007975	EFR7316	ZF	0501008064	EFR7314
ZF	0501007976	EFR7317	ZF	0501008065	EFR7315
ZF	0501007978	EFR7314	ZF	0501008082	EFR7304
ZF	0501007979	EFR7315	ZF	0501008083	EFR7305
ZF	0501007980	EFR7315	ZF	0501008084	EFR7304
ZF	0501007981	EFR7314	ZF	0501008085	EFR7305
ZF	0501007982	EFR7314	ZF	0501008087	EFR7300
ZF	0501007983	EFR7315	ZF	0501008088	EFR7301
ZF	0501007985	EFR7316	ZF	0501008090	EFR7684
ZF	0501007986	EFR7317	ZF	0501008091	EFR7685
ZF	0501007991	EFR6300	ZF	0501008098	EFR7302
ZF	0501007992	EFR6301	ZF	0501008099	EFR7303
ZF	0501007997	EFR7316	ZF	0501008261	EFR7300
ZF	0501007998	EFR7317	ZF	0501008262	EFR7301
ZF	0501008001	EFR7316	ZF	0501008263	EFR7300
ZF	0501008002	EFR7317	ZF	0501008264	EFR7301
ZF	0501008004	EFR7314	ZF	0501008325	EFR7333
ZF	0501008005	EFR7315	ZF	0501008326	EFR7332
ZF	0501008007	EFR7323	ZF	0501008335	EFR7314
ZF	0501008008	EFR7322	ZF	0501008336	EFR7315
ZF	0501008010	EFR7314	ZF	0501008412	EFR7323
ZF	0501008011	EFR7315	ZF	0501008413	EFR7322
ZF	0501008015	EFR7304	ZF	0501008533	EFR7314
ZF	0501008016	EFR7305	ZF	0501008534	EFR7315
ZF	0501008017	EFR7304	ZF	0501008543	EFR7316
ZF	0501008018	EFR7305	ZF	0501008544	EFR7317

Les correspondances de références ont pour seul objectif d'aider la recherche de référence

Cross references are there for the sole purpose of helping the reference search

CORRESPONDANCES DES REFERENCES CROSS REFERENCE LIST

MARQUE/MAKER	REF/PN OES	REF/PN	MARQUE/MAKER	REF/PN OES	REF/PN
ZF	0501008561	EFR7300	ZF	0501008935	EFR6306
ZF	0501008562	EFR7301	ZF	0501008936	EFR6307
ZF	0501008563	EFR7300	ZF	0501009063	EFR7340
ZF	0501008564	EFR7301	ZF	0501009064	EFR7341
ZF	0501008577	EFR7340	ZF	0501009095	EFR7323
ZF	0501008578	EFR7341	ZF	0501009096	EFR7322
ZF	0501008581	EFR7300	ZF	0501009125	EFR6300
ZF	0501008582	EFR7301	ZF	0501009126	EFR6301
ZF	0501008654	EFR7304	ZF	0501009127	EFR6306
ZF	0501008655	EFR7305	ZF	0501009128	EFR6307
ZF	0501008658	EFR7304	ZF	0501009138	EFR6306
ZF	0501008659	EFR7305	ZF	0501009139	EFR6307
ZF	0501008691	EFR7304	ZF	0501009198	EFR7310
ZF	0501008692	EFR7305	ZF	0501009199	EFR7311
ZF	0501008693	EFR7316	ZF	0501009212	EFR7311
ZF	0501008694	EFR7317	ZF	0501009213	EFR7310
ZF	0501008789	EFR7314	ZF	0501009227	EFR6306
ZF	0501008790	EFR7315	ZF	0501009228	EFR6307
ZF	0501008870	EFR7340	ZF	0501210168	CAC008
ZF	0501008871	EFR7341	ZF	0501210655	CAC005
ZF	0501008880	EFR7300	ZF	0501211763	CAC005
ZF	0501008881	EFR7301	ZF	0501211883	CAC030
ZF	0501008882	EFR7300	ZF	0501211884	CAC014
ZF	0501008883	EFR7301	ZF	0501213102	CAC024
ZF	0501008885	EFR7302	ZF	0501213128	EFR7306
ZF	0501008886	EFR7303	ZF	0501213129	EFR7307
ZF	0501008887	EFR7302	ZF	0501213164	CAC014
ZF	0501008888	EFR7303	ZF	0501213239	EFR7316
ZF	0501008890	EFR7310	ZF	0501213240	EFR7317
ZF	0501008891	EFR7311	ZF	0501213313	EFR7314
ZF	0501008892	EFR7310	ZF	0501213314	EFR7315
ZF	0501008893	EFR7311	ZF	0501213363	EFR7302
ZF	0501008894	EFR7300	ZF	0501213364	EFR7303
ZF	0501008895	EFR7301	ZF	0501213381	EFR7302
ZF	0501008896	EFR7300	ZF	0501213382	EFR7303
ZF	0501008897	EFR7301	ZF	0501213688	CAC007
ZF	0501008902	EFR7304	ZF	0501213689	CAC009
ZF	0501008903	EFR7305	ZF	0501214080	EFR7301
ZF	0501008904	EFR7304	ZF	0501214081	EFR7300
ZF	0501008905	EFR7305	ZF	0501215022	CAC011
ZF	0501008906	EFR7304	ZF	0501215847	EFR7300
ZF	0501008907	EFR7305	ZF	0501215848	EFR7301
ZF	0501008909	EFR7304	ZF	0501215955	EFR7304
ZF	0501008910	EFR7305	ZF	0501215956	EFR7305
ZF	0501008911	EFR7304	ZF	0501216157	EFR7314
ZF	0501008912	EFR7305	ZF	0501216158	EFR7315
ZF	0501008914	EFR7300	ZF	0501216159	EFR7314
ZF	0501008915	EFR7301	ZF	0501216160	EFR7315

Les correspondances de références ont pour seul objectif d'aider la recherche de référence

Cross references are there for the sole purpose of helping the reference search

CORRESPONDANCES DES REFERENCES CROSS REFERENCE LIST

MARQUE/MAKER	REF/PN OES	REF/PN	MARQUE/MAKER	REF/PN OES	REF/PN
ZF	0501216161	EFR7323	ZF	A0501006595	EFR7315
ZF	0501216162	EFR7322	ZF	A0501006597	EFR7314
ZF	0501216163	EFR7314	ZF	A0501006598	EFR7315
ZF	0501216164	EFR7315	ZF	A0501006599	EFR7316
ZF	0501216165	EFR7310	ZF	A0501006600	EFR7317
ZF	0501216166	EFR7311	ZF	A0501006604	EFR7300
ZF	0501216167	EFR7302	ZF	A0501006605	EFR7301
ZF	0501216168	EFR7303	ZF	A0501006698	EFR7300
ZF	0501219333	EFR7340	ZF	A0501006699	EFR7301
ZF	0501219334	EFR7341	ZF	A0501006754	EFR7306
ZF	0501298192	CAC006	ZF	A0501006755	EFR7307
ZF	0501298195	2907702	ZF	A0501006838	EFR7314
ZF	0501298536	EFR7684	ZF	A0501006839	EFR7315
ZF	0501298537	EFR7685	ZF	A0501006850	EFR7316
ZF	501213163	W0400MA1	ZF	A0501006851	EFR7317
ZF	A0501005172	EFR7303	ZF	A0501007035	EFR7302
ZF	A0501005173	EFR7302	ZF	A0501007036	EFR7303
ZF	A0501005370	EFR7302	ZF	A0501007056	EFR7317
ZF	A0501005371	EFR7303	ZF	A0501007057	EFR7316
ZF	A0501005573	EFR7306	ZF	A0501007071	EFR7316
ZF	A0501005574	EFR7307	ZF	A0501007072	EFR7317
ZF	A0501005859	EFR7302	ZF	A0501007085	EFR7304
ZF	A0501005860	EFR7303	ZF	A0501007086	EFR7305
ZF	A0501005905	EFR7302	ZF	A0501007125	EFR7303
ZF	A0501005906	EFR7303	ZF	A0501007126	EFR7302
ZF	A0501005935	EFR7302	ZF	A0501007140	EFR7301
ZF	A0501005936	EFR7303	ZF	A0501007141	EFR7300
ZF	A0501006007	EFR7316	ZF	A0501007172	EFR7316
ZF	A0501006008	EFR7317	ZF	A0501007173	EFR7317
ZF	A0501006016	EFR7302	ZF	A0501007333	EFR7314
ZF	A0501006017	EFR7303	ZF	A0501007334	EFR7315
ZF	A0501006195	EFR7314			
ZF	A0501006196	EFR7315			
ZF	A0501006211	EFR7314	NOTE		
ZF	A0501006212	EFR7315	RENAULT TRUCKS	7420515083	DF70010
ZF	A0501006293	EFR7304	RENAULT TRUCKS	7420515093	DF70010
ZF	A0501006294	EFR7305	RENAULT TRUCKS	7421526754	DF70005
ZF	A0501006296	EFR7310	VOLVO	03988838	DF70005
ZF	A0501006297	EFR7311	VOLVO	20428193	DF70010
ZF	A0501006320	EFR7304	VOLVO	20515083	DF70010
ZF	A0501006321	EFR7305	VOLVO	421571647	DF70005
ZF	A0501006378	EFR7304	VOLVO	85110496	DF70010
ZF	A0501006379	EFR7305			
ZF	A0501006380	EFR7304			
ZF	A0501006381	EFR7305			
ZF	A0501006591	EFR7314			
ZF	A0501006592	EFR7315			
ZF	A0501006594	EFR7314			

Les correspondances de références ont pour seul objectif d'aider la recherche de référence

Cross references are there for the sole purpose of helping the reference search

TRADUCTION / TRANSLATION

Français	Anglais	Allemand	Italien	Espagnol
A l'origine garnitures vissés	initial screwed pads	ursprüngl. verschraubte Beläge	pastiglie freno avvitate in origine	pastillas inicialmente montadas
Abîmer	Damage	Beschädigt	Danno, guasto	Daño
Abrasion	Abrasion	Abrieb	Abrasion	Abrasión
ABS (système antiblocage)	ABS (anti-lock brake system)	ABS	ABS (sistema antibloccaggio in frenata)	ABS (sistema de frenado antibloqueo)
Ajustage automatique	Automatic adjustment	automatische Nachstellung	correzione automatica	reajuste automatico
Ajusteurs de tringlerie de freins	Brake-linkage adjusters	Gestängesteller	Dispositivi per ripresa gioco	Ajustador de varillaje
Âme détériorée	Damaged web	Beschädigter Bremsbackensteg	Costa danneggiata	Alma, nervio dañado
Âme, âme de mâchoire	Web, shoe web	Bremsbackensteg	Costa (nervatura) di ganaschia	Alma, nervio de la mordaza, zapata alma, nervio
Amplificateur hydraulique	Hydraulic booster	Hydraulikverstärker	servofreno idraulico	servo hidráulico
ASC (contrôle de stabilité)	ASC (automatic stability control)	ASC (Automatische Stabilitäts Control)	ASC (controllo automatico stabilità)	ASC (control automático de estabilidad)
Aspect du cisaillement	Shear pattern	Scherbild	Figura di distacco	Útil de cizallar
ASR (anti-patinage)	ASR (traction control system TCS)	ASR (Antriebsschlupfregelsystem)	ASR (sistema antislittamento in accelerata)	ASR (systemas antiderrapaje)
Assistance pneumatique	Air brake assistance	Druckluftunterstützung	comando aria compressa	freno de aire auxiliár
Autobus	Bus (van)	Bus	autobus	autobus
AV (essieu avant)	FA (front axle)	VA (Vorderachse)	A (asse anteriore)	VA (eje delantero)
Avec accessoires	With accessories	Mit Zubehör	Con accessori	Con accesorios
Avec contrôle de ralentisseur	With retarder control	Mit Retardersteuerung	Con controllo retarder	Controlada joroba
Axes de pistons	Piston pins	Kolbenbolzen	Spinotti	Pernos de pistón
Axes de ressorts	Spring-eye bolts	Federbolzen	Perni per molle	Pernos para amortiguadores
Bagues d'étanchéité	Sealing rings	Dichtringe	Guarnizioni ad anello	Anillos de juntas
Bancs d'essai de freinage	Brake test benches	Bremsenprüfstände	Banchi prova freni	Banco de pruebas para frenos
Bancs d'essai de freins	Brake test benches	Bremsenprüfstände	Banchi prova freni	Banco de pruebas para frenos
Bande de garniture rigide	Brake band rigid lining	Bremsband fest	Guarnizione per freno a nastro	Forro de banda rígida
Bande moulée	Roll lining	Bremsband gerollt (flexibel)	Materiale d'attrito (guarnizione) in rotolo	Cinta flexible
Blocage des roues	Wheel lock	Blockieren der Räder	Bloccaggio delle ruote	Blocaje de ruedas
Boulette de fibres	Fibber concentrate	Faserausammlung	Grumo di fibra	Bolas de fibra
Broutement	Grabbing	Verzahnen	Traballare	Resalte, agarre
Broutement à chaud	Hot judder	Heissrubbeln	Traballamento	Hot judder, vibración
Broutement à froid	Cold judder	Kaltrubbeln	Vibrazione a freddo	Cold judder, vibración
Bruit	Noise	Geräusch	Rumore	Ruido
Bruit de dé freinage	Creep groan	Knarzen/knurren	Ruvidità a freddo	Creep groan

TRADUCTION / TRANSLATION

Français	Anglais	Allemand	Italien	Espagnol
Bruit de freinage	Brake noise	Bremsgeräusch	Rumore in frenata	Ruido de frenada
Butée de retenue	Retaining stud	Anschlagstift	Perno d'arresto	Indicador de desgaste
Câble de frein de parking	Hand brake actuation	Handbremsbetätigung	azionamento freno a mano	activación de freno de mano
Câbles et tirettes à câble de frein	Brake cables and cable controls	Bremsseile	Funi comando freno	Latiguillos de freno
Câbles flexibles bowden	Bowden cables	Bowdenzüge	Cavi bowden	Cables "bowden"
Cales de roue	Wheel chocks	Radunterlegkeile	Calzatoie per ruote	Cuñas para ruedas
Calibres pour diamètres intérieurs	Plug gauges	Meßdorne	Calibri di misura	Calibres
Came	Cam	Nocken	Camma	Leva
Cannelure type	Spline type	Zahnraden-Type	Tipo chiavetta	Tipo de ranura
Capteur de roue	Wheel sensor	Radsensor	sensore ruota	sensores de rueda
Capteurs	Sensors and transmitters	Sensoren	Sensori	Sensores
Capteurs de Vitesse	Wheel Speed Sensors	Drehzahlsensoren	Sensori di Velocità	Sensores de velocidad
Capteurs du niveau de liquide	Fluid level sensors	Füllstandsmeß- und - steuereinrichtungen	Disp. misura riserva e comando	Equipos para control y medida del nivel de llenado
Catalogues	Catalogues	Kataloge	Cataloghi	Catálogos
Certificat	Certificate	Zertifikat	Certificato	Certificado
Certificat d'acceptation	Release certificate	Freigabezertifikat	Certificato di benessere	Certificado de aceptación
Certification	Authentication, Certification	Beglaubigung, Zertifizierung	Autenticazione, Certificazione	Certificación
Chanfrein	Chamfer	Anschrägung	Smusso	Chaflán
Châssis renforcé	Reinforced suspension	verstärktes Fahrwerk	autotelaio rinforzato	suspensión reforzada
Clivage	Delamination	Schichtbildung	Delaminazione, sfaldatura	Exfoliación
Coefficient de frottement	Coefficient of friction	Reibbeiwert	Coefficiente d'attrito	Coeficiente de fricción
Collé	Adhesives	Kleber aller Art	Adesivi	Pegamentos
Colliers de flexibles	Hose clamps	Schlauchklemmen, Schlauchschellen	Morsetti serratubo, fascette	Abrazaderas para mangueras
Colliers de serrage	Clamps	Befestigungsschellen	Fascette di fissaggio	Abrazaderas
Commandes d'embrayage hydrauliques	Hydraulic clutch controls	Kupplungsbetätigungen, hydraulische	Comandi idraulici frizione	Accionamiento para embrague hidráulico
Complet avec maître cylindre	Complete with master cylinder	Mit Hauptzylinder	Incluso cilindro maestro	
Compressibilité	Compressibility	Kompressibilität	Compressibilità	Compresibilidad
Concave	Concave	Konkav	Concavo	Cóncavo
Conduite à droite	Right hand drive	Rechtslenker	Guida a destra	Con volante a la derecha
Conduite à gauche	Left hand drive	Linkslenker	Guida a sinistra	Con volante a la izquierdo
Conduite flexible	Line hose	Schlauchleitung	flessibile (tubo flessibile)	latiguillo flexible

TRADUCTION / TRANSLATION

Français	Anglais	Allemand	Italien	Espagnol
Conduite rigide	Pipe line	Rohrleitung	tubazione	latiguillo
Conduites de frein	Brake lines	Bremsleitungen	Condutture freno	Líneas/mangueras de frenos
Conformité	Compliance, Conformity	Einwilligung, Übereinstimmung	Conformità	Conformidad
Contrôle	Control	Überwachung	Controllo, collaudo	Control
Contrôle final	Final inspection	Endprüfung	Ispezione finale	Control final
Contrôle pression frein de parc	Pressure from spring brake system	Druck vom Feststellbremssystem	Pressione dal circuito di stazionamento	Control de presión de freno de estacionamiento
Contrôle visuel	Visual inspection	Sichtprüfung	Ispezione visiva	Inspección visual
Contrôle, vérification	Check	Überprüfen	Controllo	Control, verificación
Convexe	Convex	Konvex	Convesso	Convexo
Corps	Housing	Gehäuse	carcassa	carcasa
Correcteur de freinage	Brake pressure regulator	Bremskraftregler	correttore di frenata	corrector de frenado
Correcteur de freinage	Regulator	Regler	correttore di frenata	regulador
Correcteurs de Freinage Suspension Mécanique	Load Sensing Valves Mechanical Suspension	Bremskraftregler mechanisch	Correttori di Frenata Meccanici	Correctores de frenado Suspensión Mecánica
Correcteurs de Freinage Suspension Pneumatique	Load Sensing Valves Air Suspension	Bremskraftregler, pneumatisch	Correttori di Frenata Pneumatici	Correctores de frenado Suspensión neumática
Côte réparation	Oversize	Übergröße	Surdimensionato, maggiorato	Sobre medida
Couple résiduel de freinage	Residual brake drag	Restlicher Bremswiderstand	Momento residuo	Par residual
CR (cylindre roue)	WC (wheel cylinder)	Rz (Radzylinder)	cil. ruota (cilindretto ruota)	CR (cilindro de rueda)
Cylindre hydraulique	Hydraulic cylinder	Hydraulikzylinder	cilindro idraulico	cilindro de hidráulico
Cylindres à Ressort	Spring Brakes	Kombizylinder	Cilindri Doppi	
Cylindres de freins de roues	Wheel brake cylinders	Bremszylinder	Cilindret	Cilindros de frenos
Cylindres de roues	Wheel cylinders	Bremszylinder	Cilindret	Cilindros de frenos
D (diamètre) =	D (diameter) =	D (Durchmesser) =	D (diametro) =	D (diámetro) =
Décollement	Detachment	Ablösung	Distacco	Desenganche
Découpage	Stamping	Stanzen	Timbratura	Troquelado
Dessiccateurs d'air comprimé	Compressed-air dryers	Drucklufttrockner	Deumidificatori per aria compressa	Secadores de aire comprimido
Diamètre de la tête	Head diameter	Kopfdurchmesser	Diametro della testa	Diámetro de la cabeza
Diamètre de l'orifice ou taraudage	Hole diameter or thread	Durchmesser oder Gewindegröße	Diametro del foro o filettatura	
Diamètre du cercle de rivetage	Pitch circle diameter	Lochkreisdurchmesser	Diametro di foratura	Diámetro entre agujeros de remache
Diamètre du corps	Shank diameter	Schaftdurchmesser	Diametro del gambo	Diámetro de la caña
Diamètre du piston	Servo Piston diameter	Durchmesser Servokolben	Diametro del pistone	Diámetro de pistón

Français	Anglais	Allemand	Italien	Espagnol
Diamètre extérieur	Outside diameter	Aussendurchmesser	Diametro esterno	Diámetro exterior
Diamètre intérieur	Inside diameter	Innendurchmesser	Diametro interno	Diámetro interior
Diamètre moyen	Inner/core diameter	Innendurchmesser	Diametro mediano	Diámetro medio
Dimension des trous	Hole sizes	Bohrungsdurchmesser	Dimensione del foro	Tamaño del agujero
Disque plein	Solid disc	Massive Bremsscheibe	Disco pieno	Disco macizo
Disque ventilé	Ventilated disc	belüftete Bremsscheibe	Disco ventilato	Disco ventilado
Disques de frein	Brake discs	Scheibenbremse	Dischi freno	Discos de freno
Disques de frein à 4 trous	4-bore brake disc	4-Loch-Bremsscheibe	disco freno 4 fori	disco freno con 4 taladros
Disques de frein à 6 trous	6-bore brake disc	6-Loch-Bremsscheibe	disco freno 6 fori	disco freno con 6 taladros
Droit	Right	Rechts	Destra	Derecho
Ébauche d'usinage	Pregrinding	Vorschleifen	Pre-rettifica	Pre-rectificado
Écrous	Nuts	Muttern	Dadi	Tuercas
EE (émetteur d'embrayage)	CC (clutch cylinder)	Gz (Geberzylinder)	cilindro di comando	CTR (cilindro distribuidor)
Efficacité freinage	Braking efficiency	Bremswirksamkeit	Efficienza del freno	Eficacia
Effort frein de stationnement	Spring portion rating	Federspeicherkraftabgabe	Forza freno di stazionamento	Freno de esfuerzo
Encollage	Adhesive coating	Kleberbeschichtung	Copertura adesiva	Recubrimiento adhesivo
Enregistreurs de pression de freinage	Brake pressure recorders	Bremsdruckschreiber	Pressografo per impianto freni	Impresora para presión de frenado
Enregistreurs du taux de freinage	Brake rate recorders	Bremsverzögerungsmesser	Decelerometro	Medidores de desaceleración de frenado
Entraxe	Hole pitch	Lochteilung	Passo, interasse	Distancia entre dos agujeros
Épaisseur de la tête	Head thickness	Kopfdicke	Spessore della testa	Espesor de la cabeza
Épaisseur minimum	Thickness minimum	Dicke, min	Spessore minimo	Espesor mínimo
Épingle	Retaining clip	Sicherungsklammer	Coppiglia	Clip
Équipements et accessoires hydrauliques	Hydraulic equipment and accessories	Hydraulische Ausrüstungen	Equipaggiamenti idraulici	Equipos hidráulicos
Essai d'usure	Wear test	Verschleißprüfung	Prova di usura	Ensayo de desgaste
Essieu arrière	Rear axle	Hinterachse	Asse posteriore	Eje posterior
Essieu avant	Front axle	Vorderachse	Asse anteriore	Eje anterior
Essieu avant et essieu arrière	Front and rear axle	Vorder- und Hinterachse	assi anteriore e posteriore	eje delantero + eje trasero
Essieu multi-link	Multi-link axle	Multi-Link-Achse	assale Multi-link	eje Multi-Link
Essieux	Axles	Achsen	Assali	Ejes
Essieux de remorques	Trailer axles	Anhängerachsen	Assi per rimorchi	Ejes para remolques
Étalonnage	Calibration	Kalibrieren	Taratura	Calibrado
Étrier à 1 piston D=xx	Single-piston caliper D=xx	1-Kolbensattel D=xx	pinza freno a un pistoncino D = xx	mordaza de freno D=xx

TRADUCTION / TRANSLATION

Français	Anglais	Allemand	Italien	Espagnol
Étrier à 2 pistons D=xx	2-piston caliper D=xx	2-Kolbensattel D=xx	pinza freno a 2 pistoncini D=xx	mordaza con dos pistones D=xx
Étrier à 4 pistons	4-piston caliper	4-Kolbensattel	pinza freno a 4 pistoncini	mordaza con 4 pistones
Étrier avec 1 bouchon d'arrêt	Caliper with 1 retaining pin	Sattel mit 1 Haltestift	pinza con una spina di fissaggio	pinza con 1 pasador
Étrier avec 2 bouchon d'arrêt	Caliper with 2 retaining pins	Sattel mit 2 Haltestiften	pinza con due spine di fissaggio	pinza con 2 pasadores
Étrier avec nopes en fonte	Caliper with cast-naps	Sättel mit Gussnoppen	pinze freno con borchie fuse	pinzas con protuberancias de fundición
Étrier de frein	Calliper	Bremssattel	Pinza per freno a disco	Pinza de freno
Étrier de frein à disque	Disk brake callipers	Bremszangen und -sättel	Pinze per freni a disco	Pinzas y zapatas de freno
Étrier flottant	Floating caliper	Schwimmsättel	pinza freno flottante	pinza flotante
Étriers en aluminium	Alu-calipers	Alu-Sättel	pinza in alluminio	mordaza de freno de aluminio
Étriers en fonte grise	Cast iron-caliper	GG-Sättel	pinza in ghisa	pinza de fundición de gris
Étriers fixes	Fixed caliper	Festsättel	pinza freno fissa	pinza de fija
Étriers frein à 1 circuit	Single-circuit caliper	1-Kreis-Sättel	pinza freno a 1 circuito	pinza de 1 circuito
Étriers frein à 2 circuits	Two-circuit-caliper	2-Kreis-Sättel	pinza freno a 2 circuiti	pinza de 2 circuitos
Évacuation et élimination des liquides de freins	Brake fluid disposal	Bremsflüssigkeits-Entsorgung	Smaltimento fluidi per freni	Eliminación de líquidos de freno
Face de friction	Friction surface, Working surface	Reibfläche	Superficie di lavoro	Superficie de fricción
Fading (évanouissement)	Fading	Fading	Fading, affievolirsi	Fading
Fil témoin d'usure	Wear indicator cable	Kabel für Verschleissanzeiger	Cavetto indicatore d'usura	Cable del indicador de desgaste
Filetage du tube	Tube thread	Tragrohrgewinde	Filettatura del tubo	Tubo de hilo
Filetage pas a droite	Right hand thread	Rechtsgewinde	Raccordi versione destra	
Filetage pas a gauche	Left hand thread	Linksgewinde	Raccordi versione sinistra	
Flasque	Flange	Flansch	Flangia	Pestaña
Flexibles	Hoses	Schläuche	Tubi flessibili	Cámaras
Flexibles de frein et d'embrayage	Brake and clutch hoses	Brems- und Kupplungsschläuche	Tubazioni freno e frizione	Mangueras de frenos y embragues
Flexibles en caoutchouc	Rubber hoses	Gummischläuche (Triebwerk, Fahrwerk)	Tubazioni in gomma	Mangueras de goma
Fluides et huiles hydrauliques	Hydraulic fluids and oils	Hydrauliköle	Oli idraulici	Aceites hidráulicos
Foret à pointe de centrage	Pin drills	Schälbohrer	Punte a pelare	Machos de roscar
Fraisée	Hole milling machines	Lochfräser	Frese frontali	Fresadoras de agujero
Frein	Brake	Bremse	Freno	Freno
Frein à 1 circuit	Single-circuit brake	1-Kreis-Bremse	impianto frenante circuito semplice	freno de 1 circuito
Frein à deux circuits	Two-circuit-brake	2-Kreis-Bremse	impianto frenante doppio circuito	freno de 2 circuitos

Français	Anglais	Allemand	Italien	Espagnol
Frein à disque	Disc brake	Scheibenbremse	Disco	Freno a disco
Frein à disque essieu AR	Rear axle disc brake	HA-Scheibenbremse	dischi freno asse posteriore	eje trasero disco de freno
Frein à disque essieu avant	Front axle disc brake	VA-Scheibenbremse	dischi freno asse anteriore	eje delantero - disco de freno
Frein à main	Hand brake	Handbremse	Freno a mano	Freno de mano
Frein à tambour	Drum brake	Trommelbremse	freni a tamburo	tambores de freno
frein à tambour essieu AR	Rear axle drum brake	HA-Trommelbremse	tamburi freno asse posteriore	eje trasero tambores de freno
Frein Girling essieu avant	Front axle Girling-brake	VA-Girling-Bremse	asse anteriore con impianto Girling	eje delantero - Girling freno
Frein pneumatique	Air brake	Druckluftbremse	freno pneumatico	freno de aire comprimido
Frein renforcé	Heavy-duty brake	verstärkte Bremse	freno rinforzato	freno reforzado
Freinage irrégulier	Uneven braking	Ungleichmäßiges Bremsen	Sbilanciamento in frenata	Balance de frenada no correcto
Freins	Brakes	Bremsen	Freni	Frenos
Freins à disque	Disk brakes	Scheibenbremsen	Freni a disco	Frenos a disco
Freins à Disque Pneumatique	Air Disc Brakes	Pneumatische Scheibenbremsen	Freni a Disco Pneumatici	Freno de disco neumático
Freins à tambours	Drum brakes	Trommelbremsen	Freni a tamburo	Frenos de tambor
Freins de remorques	Trailer brakes	Anhängerbremsen	Freni per rimorchi	Frenos para remolques
Gaines de câbles	Cable sleeves	Kabelschutzhüllen	Guaine protezione cavi	Fundas de protección de cables
Garantie	Warranty	Garantie	Garanzia	Garantía
Garniture	Lining	Reibbelag	Guarnizione (suola)	Forro
Garniture chanfreinée	Chamfered lining	Abgeschrägter Belag	Ceppo (suola) smussato	Forro chaflanado
Garniture collée	Bonded lining	Geklebter Belag	Ceppo (suola) incollato	Forro encolado
Garniture de frein	Brake lining	Bremsbelag	Ceppo (suola) per freno	Forro de freno
Garniture de frein à tambour	Drum brake lining	Trommelbremsbelag	Guarnizione per freno a tamburo	Forro de freno de tambor
Garniture moulée	Moulded lining	Gepresster Belag	Guarnizione stampata	Forro moldeado
Garniture rivetée	Riveted lining	Genietetes Belag	Guarnizione rivettata	Forro remachado
Garniture tissée	Woven material	Gewebtes Material	Ceppo di materiale tessuto	Material tejido
Garnitures de frein	Brake linings	Bremsbeläge	Guarnizioni freno	Forros de freno
Garnitures de frein à tambour	Drum Brake Linings	Trommelbremsbeläge	Guarnizioni per freni a tamburo	Forros de freno de tambor
Garnitures de friction	Friction linings	Reibbeläge	Ferodi	Guarniciones de fricción
Gauche	Left	Links	Sinistra	Izquierdo
Glaçage	Glazing	Verglasung	Aspetto vetroso	Aspecto vidrioso
Goupille	Locating pin, Retaining pin	Zentrierbolzen, Belagsicherungsstift	Spina di posizionamento, Spina di tenuta	Centrado, Pasador rígido
Goupilles	Splints, Pins	Splinte, Stifte	Copiglie, Perni	Grupillas, Pasadores
Gravage	Impression stamping	Prägen	Incisione	Troquelado

Français	Anglais	Allemand	Italien	Espagnol
Grésillement	Chirp	Zirpen	Pigolio	Chirrido
Grondement	Rumble	Rumpeln, rütteln	Risonanza	Vibración
Groupe de pièces normalisées	Standard parts	Gruppe Normteile	Gruppo pezzi standardizzati	Grupo de piezas normalizadas
Grues mobiles	Mobile cranes	Mobilkrane	Gru mobili	Grúas móviles
Hydraulique	Hydraulic	Hydraulisch	Idraulica	Hidráulica
Indicateur chute de pression	Pressure warning switch	Druck-Warnschalter	interruttore spia pressione	interruptor de aviso de presión
Jauges d'épaisseur	Feeler gauges	Tastlehren	Calibri tastatori	Patrones para palpar
Jeux de joints d'étanchéité	Seal and gasket sets	Dichtungssätze	Set sigillanti di tenuta	Juegos de juntas
Jeux de réparation pour freins	Brake repair kits	Reparatursätze für Bremsen	Set riparazione freni	Juegos de reparación para frenos
Kit pièces de rechange	Spare Kit	Ersatzteilkit	Insieme parti ricambio	Kit de piezas de repuesto
L (longueur) =	L (length) =	L (Länge) =	L (lunghezza) =	L (largo) =
Largeur totale	Overall width	Gesamtbreite	Larghezza totale	Anchura total
Levier à Droite	Right hand	Hebel rechts	Azionamento leva destra	
Levier à Gauche	Left hand	Hebel Links	Azionamento leva sinistra	
Limiteurs de la force de freinage	Brake power limiters	Bremskraftbegrenzer	Limitatore di frenata	Reductor de servofreno
Limiteurs de vitesse	Engine speed governors	Drehzahlbegrenzer	Limitatori di velocità	Limitadores de la velocidad
Liquide de frein	Brake fluid	Bremsflüssigkeit	Liquido freni	Liquido de frenos
Longueur	Length	Länge	Lunghezza	Longitud
Longueur développée	Curved length	Bogenlänge	Lunghezza dell'arco	Longitud de desarrollo
Longueur effective	Effective length	Wirksame Länge	Lunghezza effettiva	Longitud efectiva
Mâchoire comprimée	Leading shoe	Auflaufbacke	Ganascia avvolgente	Mordaza, zapata comprimida
Mâchoire de frein	Brake shoe	Backe	Ganascia	Mordaza, zapata
Mâchoire de frein à tambour	Drum brake shoe	Trommelbremsbacke	Ganascia per freno a tamburo	Mordaza, zapata de freno de tambor
Mâchoire de frein à tambour garnie	Lined shoe assembly	Trommelbremsbacke mit Belag	Ganascia freno con guarnizione	Conjunto forro-mordaza, zapata
Mâchoire détériorée	Damaged shoe	Beschädigte Bremsbacke	Ganascia danneggiata	Mordaza, zapata dañada
Mâchoire primaire	Primary lining	Primärbelag	Ceppo (suola) primaria	Mordaza, zapata primaria
Mâchoire secondaire	Secondary lining	Sekundärbelag	Ceppo (suola) secondario	Mordaza, zapata secundaria
Mâchoire tendue	Trailing shoe	Ablaufbacke	Ganascia svolgente	Mordaza, zapata extendida
Mâchoires de frein	Brake shoes	Bremsbacken	Ganasce Freno	Zapatillas de freno
Mâchoires de frein à tambour garnies	Shoe assembly	Trommelbremsbacken mit Belag	Ganasce per freno a tamburo	Conjunto para freno de tambor
Matériau de friction	Friction material	Reibmaterial	Materiale d'attrito	Material de fricción

TRADUCTION / TRANSLATION

Français	Anglais	Allemand	Italien	Espagnol
Matériau déporté sur le support	Material out of position on the plate	Belagversatz auf Trägermaterial	Materiale scentrato rispetto al supporto	Material descentrado respecto al soporte
MC (maître cylindre)	MC (master cylinder)	Hz (Hauptzylinder)	pompa freno	CM (cilindro maestro)
MCT (maître cylindre tandem)	TMC (tandem master cylinder)	THz (Tandemhauptzylinder)	pompa freno tandem	CMT (cilindro tándem)
MCT avec 3 raccords	TMC with 3 connections	THz mit 3 Anschlüssen	pompa freno tandem con 3 attacchi	cilindro tándem con 3 conexions
MCT avec vis de butée	TMC with stop screw	THz mit Anschlagsschraube	pompa freno tandem con vite di fermo	cilindro tándem con tornillo de tope
MCT compact	Compact TMC	Kompakt THz	pompa freno tandem compatta	cilindro maestro tándem compacto
MCT fonte grise/prédécesseur	Cast-iron-TMC/predecessor	GG-THz/Vorgänger	pompa tandem in ghisa / precedente	cil. principal de fundición de gris/avisador
MC-tandem standard	Standard tandem master cylinder	Standard-THz	pompa freno tandem standard	cilindro tándem standard
Mesure	Measurement	Messung	Misura	Medida
Micro fissure	Hairline crack	Mikrofeiner Riss	Fessura sottile	Fisura superficial
Modulateur hydraulique	Hydraulic unit	Hydr. Steuereinheit	modulatore idraulico	modulador de hidráulico
Montage	Mounting	Befestigung	Montaggio	Montaje
Montage derrière l'essieu	Installation aft of axle	Einbau hinter der Achse	montaggio dietro l'assale	instalación despues del eje
Montage devant l'essieu	Installation forward of axle	Einbau vor der Achse	montaggio davanti l'assale	instalación antes del eje
Nécessaires de montage pour garnitures de freins	Brake lining mounting	Bremsbeläge-Einbausätze	Set montaggio ferodi	Forros de freno - juego
Nécessaires de réparation CR	WC-repair kit	Rz-Reparatursatz	serie riparazione cil. ruota	juego de reparación CR
Nécessaires de réparation MC	MC-repair kit	Hz-Reparatursatz	serie riparazione pompa freno	juego de reparación CM
Nombre de trous de fixation	Number of mounting holes	Anzahl Befestigungsbohrungen	Numero dei fori di montaggio	
Norme	Standard	Norm	Norma	Norma
Outils de réparation de freins	Brake repair tools	Bremsen-Reparaturwerkzeuge	Attrezzi per riparazione freni	Herramientas para reparación de frenos
Performance de freinage	Braking performance	Bremsleistung	Efficienza di frenata	Prestaciones de frenada
Pièce	Part	Teil	Parte	Apartado
Pièces de freins	Brake parts	Bremsen-Bauteile	Componenti freno	Piezas de frenos
Pièces détachées de freins à disque	Disc brake parts	Scheibenbremsen-Bauteile	Particolari per freni a disco	Piezas para frenos de disco
Pièces détachées de freins à tambours	Drum brake parts	Trommelbremsen-Bauteile	Particolari per freni a tamburo	Piezas para frenos de tambor
Pièces en fonte	Casting	Gußteile	Parti fuse	Piezas de fundción

Français	Anglais	Allemand	Italien	Espagnol
Pièces en fonte d'aluminium et d'acier	Cast aluminium and cast steel parts	Spezialteile aus Aluminium- und Stahlguß	Parti speciali fuse in alluminio e acciaio	Piezas especiales de aluminio y fundición de acero
Pieds à coulisse	Calliper gauges	Meßschieber	Calibri a corsoio	Deslizadores de medición
Pinces à mâchoires réglables	Pipe grips	Rohrzangen	Pinze da idraulico	Tenazas para tubos
Piston	Pistons	Kolben	Pistoni	Pistones
Planéité	Flatness	Ebenheit	Planarità	Planitud
Plaquette anti-bruit, revêtement anti-bruit	Anti noise shim	Geräuschdämpfungsblech	Placchetta, lamella anti-vibrazione	Placa, lámina antirruído
Plaquette de frein à disque	Disc brake pad	Scheibenbremsbelag	Pastiglia per freno a disco	Pastilla de freno de disco
Plaquette finie	Pad assembly	Scheibenbremsbelag Montage	Assemblaggio delle piastrine freno	Montaje/ conjunto de pastillas
Plaquettes de frein à disque	Disc brake pads	Scheibenbremsbeläge, Bremsklötze	Pastiglie per freni a disco, Pastiglie freno	Pastillas de freno de disco
Politique qualité	Quality policy	Qualitätspolitik	Politica della qualità	Política de calidad
Pour garnitures de frein sans accessoire	For brake pads without accessories	für Belagsätze ohne Zubehör	per pastiglie freno senza accessori	para juego de pastilla sin accesorios
Prédominance	Predominance	Druckvoreilung	Predominanza	Predominio
Produits de nettoyage pour freins	Brake cleaning agents	Bremsenreinigungsmittel	Detergenti per freni	Productos de limpieza para frenos
Purge	Purge	Regeneration	Scarico	Purga
Purgeurs et appareils de remplissage pour circuits de freinage	Brake bleeding and filling devices	Bremsenentlüftungs- und -befüllgeräte	Apparecchi per sfiato/rifornimento freni	Aparatos de purga y llenado de frenos
Quantité	Quantity	Menge	Quantità	Cantidad
Rainure	Groove, slot	Nut	Scanalatura	Ranura
RE (récepteur d'embrayage)	SC (slave cylinder)	Nz (Nehmerzylinder)	cilindro ricevitore	CRE (cilindro receptor)
Rectifieuses de bandes de roulement	Tire tread levelling machines	Egalisiermaschinen	Macchine pareggiatrici	Máquinas para equiparar neumáticos
Rectifieuses de surface	Surface grinders	Planschleifmaschinen	Spianatrici	Máquinas de afilado plano
Rectifieuses mâchoires et garnitures de freins	Brake shoe and lining grinders	Bremsbacken- und Bremsbelag-Schleifmaschinen	Rettificatrici per ceppi e guarnizioni freno	Máquinas para afilar mordazas y forros de frenos
Récupération	Recovery	Erholung	Recupero	Recuperación
Redan, épaulement	Under hang	Absatz	Sporgenza della piastrina	Desplazamiento, entrante
Réducteurs de Pression	Pressure Proportioning Valves	Druckwandler	Riduttori di Pressione Proporzionali	
Référence du matériau	Material reference	Materialbezeichnung	Marchatura di identificazione	Referencia

TRADUCTION / TRANSLATION

Français	Anglais	Allemand	Italien	Espagnol
Regarnissage	Relining	Neubelegen	Sostituzione delle guarnizioni	Restauración de zapatas
Règlement CEE	Accordance with EC regulation	EG-Vorschrift	normativa CE	según normativa CEE
Régulateur de freinage	Regulator	Regler	correttore di frenata	regulador
Régulateurs	Regulators	Regler	Regolatori	Reguladores
Régulateurs de la force de freinage	Brake power regulators	Bremskraftregler	Regolatore di frenata	Regulador de servofreno
Réservoir	Reservoir	Behälter	serbatoio	recipiente
Résistance au cisaillement	Shear strength	Scherfestigkeit	Resistenza a sollecitazione di taglio	Resistencia al cizallamiento
Ressort à retenu	Retaining spring	Haltefeder	molla di ritegno	muelle de sujeción
Ressorts	Springs	Federn (Motor, Fahrwerk)	Linguette, Molle, Molletta	Amortiguadores, Muelles
Revêtement anti-bruit	Anti-noise material	Dämpfungsmaterial	Guarnizione antivibrante sul supporto	Recubrimiento anti-ruido montado
Revêtement anti-bruit au dos	Anti-noise backing material	Geräuschkämpfungsmaterial	Guarnizione anti-vibrante sul supporto	Recubrimiento anti-ruido montado
Rivet	Rivet	Niete	Rivetto	Remache
Riveteuses de garnitures de freins	Brake lining riveting machines	Bremsbelag-Nietmaschinen	Rivettatrici per guarnizioni freno	Máquinas para remachar forros de frenos
Rivets	Rivets	Niete	Ribattini	Remaches
Robinets de Commande à main	Handbrake Valves	Handbremsventile	Distributoria mano	
Rodage	Bedding-in	Einlauf	Rodaggio	Rodaje
Roue	Wheel	Rad	ruota	rueda
Roue jumelée	Twin tyres	Doppelbereifung	ruote gemellate	cubierta doble
Roue simple	Single tyre	Einfachbereifung	ruota singola	cubierta simple
Roues	Wheels	Räder	Ruote	Ruedas
Roues dentées	Gears	Zahnräder	Ingranaggi	Ruedas dentadas
Rouleau moulé	Moulded roll	Gepresstes Band	Rotolo stampato	Cinta moldeada
SCS (système de contrôle stop)	SCS (stop control system)	SCS	SCS (sistema controllo frenata)	SCS (sistema de control de frenada)
Segment de frein à tambour (véhicules utilitaires et poids lourds)	CV lining	Trommelbremsbelag für Nutzfahrzeuge und schwere Lastwagen	Ceppo (guarnizione, suola) per freno a tamburo veicoli industriali	Forros de freno para vehículos comerciales
Semelle détériorée	Damaged platform	Beschädigtes Auflageblech	Fascia danneggiata	Llanta, pista dañada
Sensibilité pression	Pressure sensitivity	Druckempfindlichkeit	Sensibilità alla pressione	Sensibilidad a la presión
Sensibilité température	Temperature sensitivity	Temperaturempfindlichkeit	Sensibilità alla temperatura	Sensibilidad a la temperatura
Sensibilité vitesse	Speed sensitivity	Geschwindigkeitsempfindlichkeit	Sensibilità alla velocità	Sensibilidad a la velocidad

Français	Anglais	Allemand	Italien	Espagnol
Services d'entretien des freins	Brake repair and replacement services	Bremsen-Aufbereitung	Servizio freni	Servicio para frenos
Servo	Boosters	Servogeräte	Servomeccanismi	Servo aparatos
Servo frein	Booster unit	Bremsgerät	servofreno	servofreno
Servo frein court	Short brake booster	kurzes Bremsgerät	servofreno corto	servofreno corto
Servo frein standard	Standard booster unit	Standard-Bremsgerät	servofreno standard	servo freno standard
Servo freins	Brake Servo Units	Bremskraftverstärker	Servofreni	Servofrenos
SGT (mâchoires de frein à tambour)	DBS (drum brake shoes)	TBB (Trommelbremsbacken)	ganasce freno	ZDF (zapatillas de freno)
Sortie hydraulique	Hydraulic output	Hydraulischer Ausgang	Uscita idraulica	
Support	Bracket	Träger	Supporto	Soporte
Système antiblocage (ABS)	Anti-lock braking system (ABS)	Antiblockiersystem (ABS)	Sistema antibloccaggio (ABS)	Sistema de frenado antibloqueo
Systèmes de freinage	Brake systems	Bremsanlagen	Impianti freno	Frenos
Systèmes régler d'anti patinage (ASR)	Anti-slip regulator systems (ASR)	Antischlupfregel-Systeme (ASR)	Sistemi regolari antislittamento (ASR)	Sistemas de antideslizante (ASR)
Tambour de frein	Brake drum	Bremstrommel	Tamburo per freno	Tambor de freno
Tambours de freins	Brake drums	Bremstrommeln	Tamburi freno	Tambores de freno
Témoin d'usure	Wear indicator	Verschleissanzeiger	Indicatore d'usura	Indicador de desgaste
Témoin d'usure mécanique	Screech wear indicator	Kratzblech	Indicatore a vibrazione	Testigo de desgaste mecánico
Témoins	Tell-tales	Kontroll-Leuchten	Spie di controllo	Luces de control
Témoins d'usure	Wear indicators	Verschleissanzeiger	Indicatori di usura	Indicadores de desgaste
Témoins d'usure de garnitures de freins	Brake lining wear tall-tales	Bremsbelag-Verschleißanzeiger	Indicatore consumo ferodi	Indicador de desgaste de guarniciones de frenos
Testeurs de freins	Brake testers	Bremsenprüfgeräte	Apparecchi controllo freni	Aparatos para prueba de frenos
Testeurs de liquide de frein	Brake fluid testers	Bremsflüssigkeits-Testgeräte	Tester per liquido freni	Aparatos de prueba para liquido de frenos
Testeurs de pression de frein	Brake pressure testers	Bremsdruckprüfgeräte	Apparecchi prova pressione freni	Aparatos para prueba de presión de frenado
Tolérance	Tolerance	Toleranz	Tolleranza	Tolerancia
Tours et rectifieuses pour tambours et disques de freins	Brake drum and disc turning and grinding machines	Bremstrommel- und Bremsscheiben-Dreh- und Schleifmaschinen	Torni e rettifiche per tamburi e dischi freno	Máquinas de torneado y afilado
Tours pour garnitures de freins	Brake lining lathes	Bremsbelag-Abdrehmaschinen und -geräte	Torni ed attrezzi per ripassaggio guarnizioni freno	Máquinas y equipos para torrear forros de freno
Tous types	All types	alle Typen	tutti tipi	todos tipo
Trou de guidage	Lead hole	Führungsloch	Foro piombato	Agujero de taladro

TRADUCTION / TRANSLATION

Français	Anglais	Allemand	Italien	Espagnol
Trou de lamage conique	Tapered counter bore hole	Senkloch konisch	Foro conico con bassofondo piano	Agujero avellanado cónico de fondo plano
Trou de lamage droit	Straight counter bore hole	Senkloch zylindrisch	Foro piano con bassofondo piano	Agujero avellanado recto de fondo plano
Trou de lamage plan	Counter bore	Zylindrische Ansenkung	Foro con bassofondo piano	Avellanado de base plana
Trou de positionnement	Locating hole	Halte Loch	Foro di posizionamento	Agujero de centraje
Trou de rivet	Rivet hole	Nietlöcher	Fori di rivettatura	Agujero de remache
Trou fraisé	Counter sunk hole	Nietboden konisch	Foro piano con bassofondo conico	Agujero avellanado recto de fondo cónico
Trou rivet matière	Spigot hole	Arretierungsloch	Foro degli spinotti	Agujero de anclaje
Trous de rivet	Rivet holes	Nietlöcher	Fori di rivettatura	Agujeros de remache
TU (témoin d'usure)	WI (wear indicator)	WK (Warnkontakt)	RU (rilevatore usura)	CD (contacto de desgaste)
Tubulures	Tubes	Rohre (Meterware)	Tubi	Tubos
Type de frein	Brake type	Bremsentyp	Tipo di freno	
Unité de Commande Électronique	Electronic Control Units	Elektronische Steuergeräte	Unità di Controllo Elettroniche	
Usinage final	Finish grinding	Fertigschleifen	Rettifica di finitura	Rectificado final
Valves de Contrôle	Control Valves	Wegeventile	Valvole di Controllo	
Valves de Desserrage	Manoeuvring Valves	Löseventile	Rubinetti di Sfrenatura	
Valves de Desserrage	Park/Shunt Valves	Park-/Rangierventile	Valvole di Sfrenatura	
Valves de Desserrage Rapide	Quick Release Valves	Schnelllöseventile	Valvoledi Scarico Rapido	
Valves de Nivellement	Levelling Valves	Luftfederungsventile	Valvole Livellatrici	
Valves de Purge	Drain Valves	Entwässerungsventile	Valvole di Spurgo	
Valves Relais	Relay Valves	Relais ventile	Valvole Relé	
Vis	Screw	Schrauben	Perni, Viti	Tornillos
Vis d'étrier	Caliper screw	Sattelschraube	vite pinza	tornillo de pinza
Voile du disque	Run out	Scheibenschlag	Sfarfallamento	Run out, ángulo
Voile torsion	Twist	Verdrehung	Svergolo	Alabeo

GIL Automotive remet à jour la documentation sur le site
GIL Automotive will update the documentation on the site

www.GiL-Automotive.com



Avis de non-responsabilité

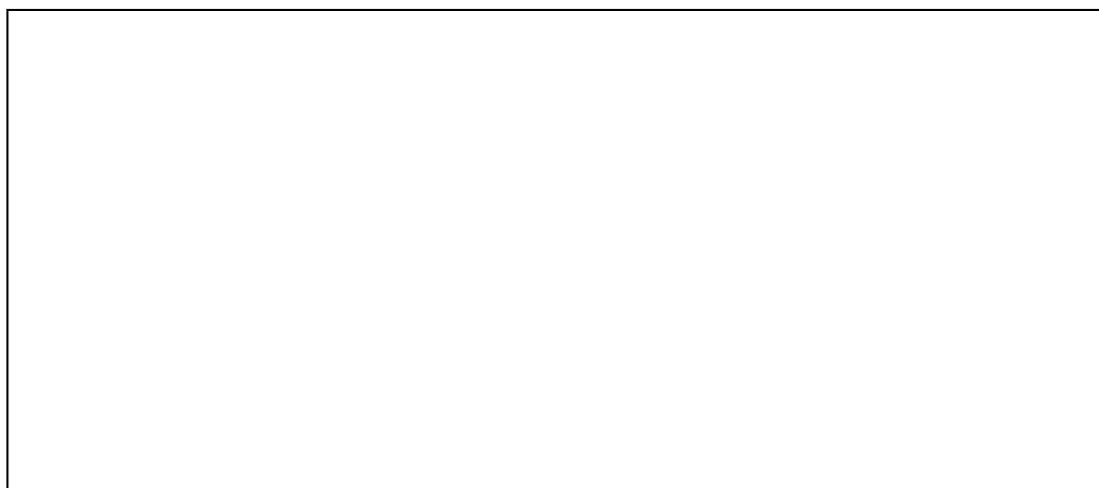
Les marques désignées sont des marques déposées par leurs propriétaires respectifs. GIL Automotive n'est en aucun cas lié, affilié ou associé aux propriétaires de ces marques. Les produits de GIL Automotive présentés dans ce document ne sont ni recommandés ni autorisés par les propriétaires de ces marques.



Disclaimer

The designated trademarks are registered marks of their respective owners and GIL Automotive is not commercially connected, affiliated, or associated with any of the owners of such marks. The GIL Automotive products presented herein are not endorsed or authorized by any of the trademark owners.

Cachet du distributeur / Distributor stamp



11 Route du Môle 2/3 - BAT B27- CE 228
92637 GENNEVILLIERS Cedex - France
Tél. : +33 1 45 06 68 30
E-mail: info@GiL-Automotive.com
Web site : www.GiL-Automotive.com